

# Rules Handbook

## *A Guide to the Rules Relating to Wells and Borings*

*Minnesota Rules,  
Chapter 4725*

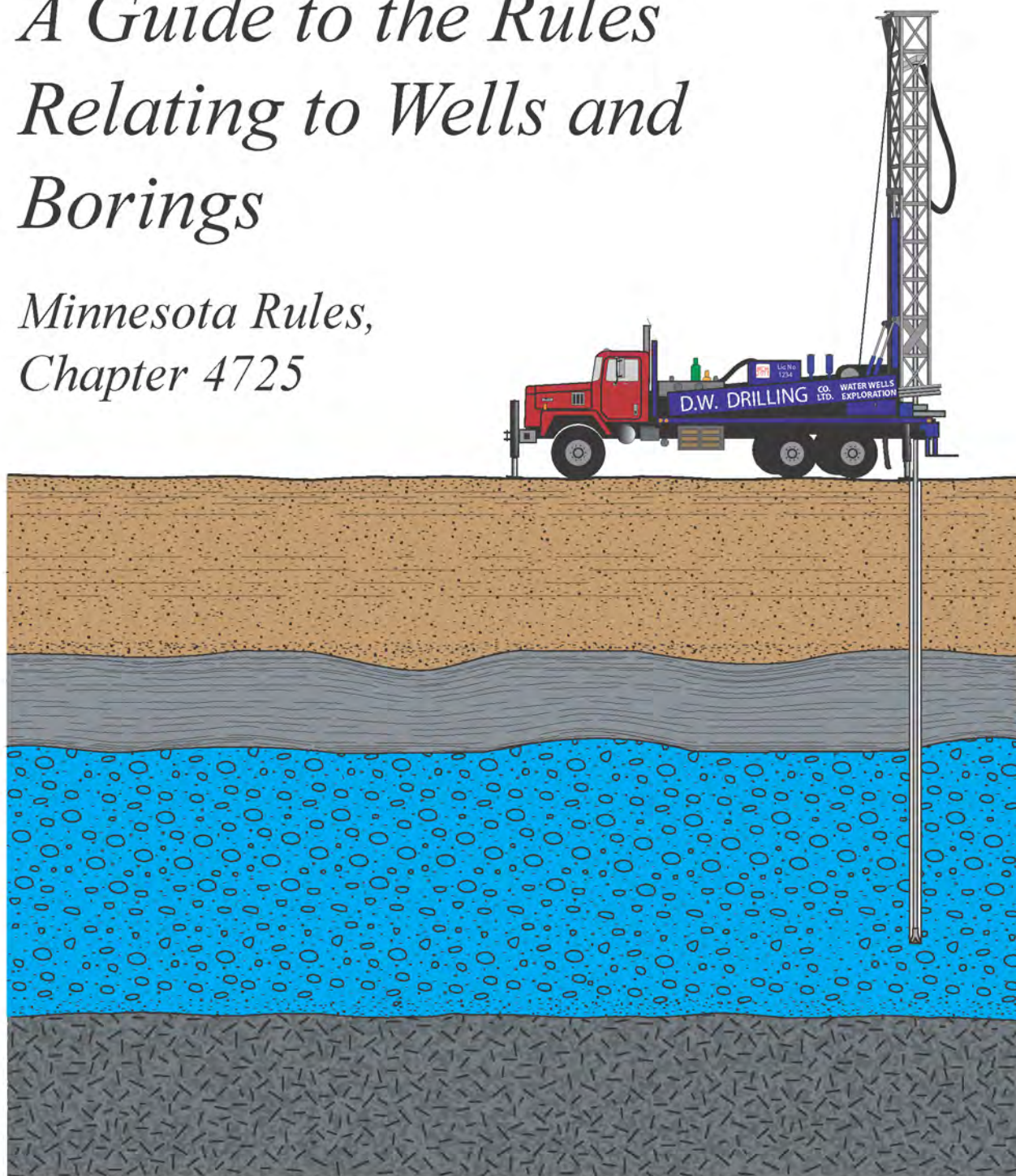

*Minnesota Department of Health*



Well Management Section  
625 North Robert Street, P.O. Box 64975  
St. Paul, Minnesota 55164-0975  
651-201-4600 or 800-383-9808  
[www.health.state.mn.us/divs/eh/wells](http://www.health.state.mn.us/divs/eh/wells)

**RULES HANDBOOK  
A GUIDE TO MINNESOTA RULES  
CHAPTER 4725  
WELLS AND BORINGS  
March 31, 2011**

**INTRODUCTION**

This handbook has been prepared to assist in understanding and implementing Minnesota Rules, Chapter 4725, the Rules Relating to Wells and Borings, effective August 4, 2008. Subsequent revisions to Minnesota Statutes, Chapter 103I, or Minnesota Rules, Chapter 4725, take precedence. Revisions to the law or rules are published in the *State Register*. The Revisor of Statutes' Web site for statutes, laws, and rules is [www.revisor.mn.gov/pubs](http://www.revisor.mn.gov/pubs). Laws, rules, contacts, fees and other information in this handbook are current as of the printing date of this handbook, but may change. The Minnesota Department of Health (MDH), Well Management Section Web site at [www.health.state.mn.us/divs/eh/wells](http://www.health.state.mn.us/divs/eh/wells) is a source of current information.

**HANDBOOK ORGANIZATION**

The handbook is organized into the following major components:

- INTRODUCTION
- SUBJECT INDEX
- RULES AND COMMENT
- APPENDICES

The **INTRODUCTION** is a short description of the handbook. The introduction explains the purpose, organization, and use of the handbook, and provides background information on reading and understanding the rules.

The **SUBJECT INDEX** is an alphabetical subject listing for the entire handbook. The index includes key words and phrases used in the rule, rule comments, and appendices.

The **RULES AND COMMENT** contains the actual rule language followed by comments, annotation, diagrams, references, and additional nonrule text. *The rule language is in larger italic text that is shaded.* The comments and annotation are in regular type. The comments are not intended as a substitute for the rules or the statute. If annotated language is inconsistent with rule or statute language, the language in the statute or rule prevails.

The **APPENDICES** are divided into three sections. The **index and materials** section contains an index of the appendices, and lists of products such as pitless units, drilling fluids, and at-grade vaults, which are known to meet the standards of the rules. The **rules and statutes** section contains other rules or statutes which are referenced in the well and boring rules, such as Minnesota Statutes, Chapter 103I, and portions of the Minnesota Rules, Chapter 4715 (Minnesota Plumbing Code). The **information** section contains background information and references such as state and local government telephone numbers, annular volume tables, conversion factors, hydrogeologic information, and special well and boring construction area maps.

## **READING A RULE**

The entire rules document is referred to as Chapter 4725. A rule “**part**” is a four-digit number suffix after the chapter number (4725) and a title such as “**part 4725.0475 ACTIVITIES REQUIRING LICENSURE OR REGISTRATION.**” A rule part, such as part 4725.0475, is divided into numbered **subparts** such as “Subpart 1. **Activity requiring licensure or registration.**” or “Subpart 2. **Exemptions to licensure or registration.**” Subparts may be divided into “**items**” which are given capital letters such as “A”. Items can be divided into “**subitems**” which are given a number in parentheses such as (1). In certain instances, a rule part may be broken directly into items without subparts.

## **RULES ORGANIZATION**

Minnesota Rules, parts 4725.0050 through 4725.0410 apply to all wells and borings regulated by the rule. Minnesota Rules, parts 4725.0475 through 4725.1810 contain requirements for certification, licensing, and registration. Minnesota Rules, parts 4725.1820 through 4725.1855 contain notification, permit, and reporting requirements. Minnesota Rules, parts 4725.2010 through 4725.3875 contain general construction and use requirements that apply to all wells and borings unless more or less restrictive standards are established in following rule parts. The remaining rule parts pertain to specific types of wells or borings. For example, Minnesota Rules, parts 4725.4050 through 4725.6050 relate to water-supply wells. Rule parts within the “water-supply well” section contain additional requirements, restrictions, or exemptions for dug wells, public water-supply wells, and remedial wells. Minnesota Rules, parts 4725.6150 to the end of the rules at Minnesota Rules, part 4725.7450, contain exemptions, restrictions or additional requirements for dewatering wells, monitoring wells, vertical heat exchangers, elevator borings, and environmental bore holes.

## **USE OF THE RULES**

In order to determine which regulations apply to a certain type of well or boring, it is necessary to read the general requirements and any special requirements or exemptions. Specific requirements or exemptions for a particular type of well or boring supersede more general requirements. For example, to find the requirements for the construction of remedial wells, the general well and boring requirements of Minnesota Rules, parts 4725.0050 through 4725.3875 must be consulted, along with Minnesota Rules, parts 4725.4050 through 4725.6050 since remedial wells are a type of water-supply well. Minnesota Rules, part 4725.6050 is of particular importance since it contains exemptions and additional requirements for remedial wells.

These rules regulate the location, construction, repair, and sealing of wells and borings as defined in Minnesota Statutes, Chapter 103I, and Minnesota Rules, Chapter 4725. The rules also regulate the location of contamination sources, buildings, and certain utilities near wells or borings. “Wells” include, but are not limited to, private and public drinking water wells, irrigation wells, monitoring wells, dewatering wells, remedial or recovery wells, and wells used for commercial or industrial supply. “Borings” include environmental bore holes, vertical heat exchangers, and elevator borings. Exploratory borings are also a type of boring as defined in Minnesota Statutes, Chapter 103I. However, exploratory borings are regulated under Minnesota Rules, Chapter 4727, not under Chapter 4725.

## **ADDITIONAL INFORMATION**

For further information, the Well Management Section of the MDH may be contacted. The MDH Well Management Section Web site is [www.health.state.mn.us/divs/eh/wells](http://www.health.state.mn.us/divs/eh/wells). The Web site contains considerable information including fact sheets about water quality issues, well sealing, licensing, and disclosure information; and links to County Well Index (CWI); the rules and law; as well as other information. The MDH Well Management Section office locations and telephone numbers are found in the appendix. The appendix also contains a listing of counties and cities which have been delegated certain well permitting, inspection, and enforcement responsibilities from the MDH.

## **TRADE NAMES**

Trade names or models are listed for reference only. Listing of trade names or products does not constitute endorsement by the MDH or appropriateness for specific applications. The information is deemed accurate as of the date of printing; however, due to changes in product models or formulation, the reader should verify that products meet the intended use and the standards of the rule before the product is used.

## **FEES**

Fee amounts listed in this handbook are current as of the date of printing, but may change. Fees are established in Minnesota Statutes, Chapter 103I, which should be consulted.

## SUBJECT INDEX RULES HANDBOOK

### A

- Abandoned well (also see Sealing), 72, 270, 448, 499
- Abbreviations, 79-81, 463
- Above-ground connections, 241-244, 331-333
- Absorption area, 31, 302, 304, 308, 319
- Acid treatment, 265-266
- Additives, 36, 37, 40, 70, 106, 216, 221, 341, 342, 347, 387, 404
- Administrative penalty order (APO), 90
- Advisory areas (see Special Well and Boring Construction Area)
- Advisory council on wells and borings, 44, 118, 119, 440
- Aggregate, 40
  - exploration, 48, 83
  - use in grouting, 235
  - use in sealing, 280
- Agricultural
  - chemical, 32, 247, 303, 305, 307, 311, 312, 321, 444
  - chemical safeguards, 303, 305, 321
  - drain tile, 316
- Agriculture department, 85, 409, 465
- Air gap, 150, 191, 245-246, 248, 255, 256, 266, 365, 387, 430-431
- Air test (sewer), 310, 313, 315, 337, 434-435
- Alluvium (see Unconsolidated materials)
- American National Standards Institute (ANSI), 80, 216
- American Society for Testing and Materials (ASTM), 80
- Animal
  - building, 308, 316
  - feedlot, 32, 51, 55, 306, 307, 318, 319
  - manure, 32, 55, 303, 304, 305, 306, 319
  - rendering plant, 312
  - unit, 32-33, 306, 307, 308
  - yard, 167
- Anhydrous ammonia, 304, 312
- Annular
  - space, 34, 52, 76, 180-18, 196, 222-223, 334-335, 357, 358, 370, 375, 376, 386
  - volume between casings, 479
  - volume between casing and hole, 477-478
- ANSI/NSF
  - Standard 60, 36, 38, 58, 81, 216, 219, 221, 265, 347, 397-404, 406-408
  - Standard 61, 81, 206, 207, 242, 332, 338
- ANSI pipe schedule, 481
- API, 36, 57, 66, 70, 80, 194-195, 200, 202
- Appendix
  - table of contents, 25-26
  - index, 395-396
- Application to all wells, 83-88
- Appropriation permit, 52, 71, 84, 148, 255, 370, 485
- Aquifer, 34, 41, 48, 51, 55, 492-498
- Aquifer interconnections, 179-181
- Arsenic, 352-354, 494, 514, 554, 574-580
- Artificial basin, 51

At-grade, 35, 74, 106, 141, 142, 143, 144, 146-147, 158, 188, 244, 366, 369, 375, 377, 380-383, 392  
manhole approved list, 424

## **B**

Backflow prevention (see Cross connections)  
approved devices, 245-247

Backwash basin, 361

Bacteria (see Total coliform bacteria)

Basalt, 35, 174

Basement, 45, 75, 167, 269, 309, 313, 314, 338, 366 369, 502-503

Basin, 55, 59, 303, 305, 306, 312, 317, 319

artificial, 48, 51, 391

Bedrock, 146, 170, 209, 210

confining layer, 40, 180-181

definition, 35-36, 76

weathered, 36

well or boring, 179-184, 209-210, 228-235, 238-239, 250-254, 290-296

Below-grade connection, 242-243, 331-333

Bentonite

between gravel pack and grout, 235-236

cement mixtures, 37, 57-58

chips, 225, 235, 375

definition, 37

drilling fluid, 289, 357

granular, 37, 221, 222, 228, 235-237

grout, 36-37, 221-222

grout density, 37

grout formula, 36, 221

pellets, 235, 375

Blank screen, 211

Blasted and bailed, 235, 272, 279, 280

Bond (see License/registration, bond)

Bored well (see Dug well)

Borehole below screen, 229

Boring, 38, 78, 83, 437

Bottled water, 85

Building

distance to well or boring, 192

drain (see Footing drain), 85, 316, 337, 435

well or boring located in, 189-191

Bulk pesticide, 305, 307

Buried

pressure tank, 67, 79, 267, 338

pressure tank approved list, 424

sewer, 310, 314-316

sewer testing, 315-316

slab, 198

suction line, 333-335

well or boring, 269

Business hours, 137-138

## C

Canopy, 192

Cap, (see Casing, cap or cover)

Casing

12 inches above grade, 147, 191, 196, 197, 198, 200, 241, 267, 269, 331-332, 340, 362, 370, 380

above flood level, 299

below ground, 197-198, 242-244, 331-332

buried seal, 269

cap or cover, 199-200, 241-244, 376, 377

centralizers, 197

concrete, 355

connections, 242-244, 331-333

couplings, 46, 193-194, 204-208, 374

definition, 38

diameter, 197, 198

driven, 46, 196, 198, 226, 228, 275, 375

dug well, 355

extension (buried well), 269

extension (pitless), 331-332

flush threaded, 193, 194, 204, 205, 243, 365, 373-374

height, 147, 191, 196, 197, 198, 200, 241, 267, 269, 331-332, 340, 362, 370, 380

inner/outer, 196-197, 198, 480

in bedrock, 209-210, 228-234

inside diameter, 197

joints, 193-194

liners, 196-197, 275

markings, 194-195

mill papers, 195

minimum depth, 327

minimum diameter, 197

multiple, 198

new, 194

offsets, 198

outer casing in unconsolidated formations, 197

perforation, 273-276

plastic, 204-210, 373-374

plastic couplings, 206-207

plastic in bedrock, 209-210

plastic threads, 207

reduction, 198

remarking, 202

removal, 267, 276

salvaged, 194

schedule, 193, 200, 206, 274, 481

specifications, 200-207, 373-374

stainless steel, 374

steel, 200-203

surface, 196, 209, 226, 358, 584

telescoped, 196, 275

temporary, 195-196, 228, 229

testing, 195

vent, 38, 241, 339-341, 362

welding, 193

Cathodic protection holes, 83, 105

Cavernous rock, 209, 235, 280, 290-293, 350, 582, 583  
 Cement (also see Concrete, Neat-cement, Portland cement)  
     accelerators, 70, 281  
     bentonite mixtures, 37, 57-58  
     rapid setting, 70  
     wait on (cement), 225  
 Cement-sand grout, 38-39  
 Centralizers (see casing, centralizers)  
 Certification, 111-118, 130-135  
 Certified representative, 39  
 Cesspool, 39-40, 307  
 Chapter  
     103I (well law, also see Law), 1, 31, 437-462  
     4715 (plumbing code), 66, 85-86, 108, 149, 245-247, 313, 314-316, 429-435  
     4720 (public water supply rules), 67, 359-360  
     7020 (feedlot rules), 32, 51, 55, 59, 303, 305, 306, 319  
     7080 (septic rules), 31, 53, 74, 302  
 Check valve, 149-150, 246, 247, 272-273, 337, 387, 432  
 Chemical treatment, 106, 107, 265-266, 273  
 Chemigation, 85, 247, 321, 326  
 Chlorine, 215, 265, 266, 289, 318, 333, 341, 345-350, 352, 358, 375  
     approved materials, 265, 347, 406-421  
     exemption, 265, 348  
     mixing table, 348-349  
     residual, 215  
 Cistern, 285, 316, 500  
 Clay, 34, 36, 40-42, 44, 48, 107, 173, 175, 180, 211, 249, 279, 318, 327, 328, 492  
 Clear water drainage, 74, 316, 317, 361  
 Coliform bacteria (see Total coliform bacteria)  
 Collapse, 159, 167, 169, 196, 199, 210, 212, 222, 225, 226, 275, 371, 392  
 Collector sewer, 310, 314  
 Commissioner's orders, 89  
 Community public water supplies (see Public water supplies)  
 "Completion" of wells and borings, 40, 160-161, 169-170, 195, 222, 241, 242, 350, 358  
 Concentric piping, 167, 334-337  
 Concrete, 40, 47, 80, 190, 197, 244, 277-280, 355  
 Conductivity, hydraulic, 34, 40-41, 44, 48, 51, 180, 391  
 Confining  
     layer, 34, 40-43, 47-48, 140, 171, 179-181, 213, 229, 231, 235, 238, 249-251, 275-276  
     materials, 44  
 Contact hour, 44, 125-126  
 Contamination  
     liability, 443-444, 449  
     sources (isolation distances), 301-326  
     sources placed near existing wells, 301, 449  
     sources removed, 302  
 Continuing education (see License/registration, continuing education)  
 Conversion  
     at-grade, 141  
     factors, 486-488  
     license, 110  
     public supplies, 359  
     wells and borings, 138, 144



Cooling water, 77, 148, 185, 312, 504-506  
County planning and zoning offices, 470-475  
County well index, 3, 171, 343, 465, 503  
Couplings, casing (see Casing, couplings)  
Cretaceous deposits, 35-36, 229  
Cross-connections, 245-248, 430-434  
Cuttings, 36, 45  
    disposal, 84, 85, 216-217  
    filling annular space, 221, 225-226, 236-237, 345, 358, 375  
    samples, 176-177  
    sealing, 278

## **D**

Decals, 124, 127-129  
Decks, 189, 192  
Delegated local programs, 86, 88, 92, 93, 97, 98, 101, 137, 139, 140, 152, 170, 270-271, 302, 467-469  
Demolition, 284, 285, 302, 311  
Development, 70, 106-107, 185, 209, 15, 225, 327, 357  
Dewatering well  
    at-grade, 35  
    construction, 87, 179, 369-371  
    contractor, 45  
    definition, 45, 78, 437  
    fees, 94-85  
    licensing, 110, 117, 134  
    maintenance permit, 162-165  
    notification, 142-143, 158-160  
    permit (now notification), 95  
    sealing notification, 152  
Discharge lines, 248, 333, 337-338  
Disclosure  
    of wells at property transfer, 283-284, 445-447, 499-501  
    fee, 96-97  
Disinfection, 345-350, 357-358, 366-367  
Disposal in well or boring, 185  
Disposal of cuttings and drilling fluids, 85, 185, 216-217  
Dog kennel (see Kennel)  
Dolomite, 174, 209, 228, 229, 239, 290-296  
Drainfield (see Soil dispersal system)  
Drain tile, 45, 74, 316, 317, 369  
Drawdown seals, 255, 272, 339, 377  
“Dresser” couplings, 242-243  
Drilling  
    additives, 216, 265  
    additives approved list, 397-405  
    fluids, 37, 45, 80, 85, 107, 215-217, 289, 327, 357-358, 375  
    fluid disposal, 84, 85, 216-217  
    foam, 216, 397-405  
    lost circulation materials, 405  
    machine, 45-46, 53, 95, 127-129, 188, 190, 455  
    water, 215-216  
    weighting agents, 281, 405  
Driven casing, 46, 198, 226, 228, 275, 375  
Drive-point, 46, 54, 78, 87, 91, 109, 115-116, 140, 165-167

Drive shoe, 196, 198-199, 210, 228, 229  
Drop pipe, 60, 337, 347, 501  
Dry well, 40, 72, 307, 319  
Dug well  
    construction and sealing, 179  
    contractor, 46, 115-116  
    definition, 46-47  
    notification, 133, 138-142  
    sealing, 273, 279  
    special construction requirements, 318, 354-356  
Dump, 302, 319  
Dye-tracing, 185

## **E**

E-coli, 581-584  
Electric lines, 187-189  
Electrical  
    grounding, 106  
    connections, 244  
Electronic fee payment, 96  
Elevator boring  
    construction and sealing 179  
    contractor, 47, 110, 117-118, 125  
    definition, 47, 437  
    fee, 93  
    “holeless”, 110, 389  
    isolation distance, 312  
    license, 110, 117-118, 450  
    permit, 155-160, 450  
    special construction requirements, 389-390  
Enforcement, 89-92  
Emergency notification or permit, 158-160  
Emergency variance, 100  
Environmental bore hole  
    definition, 47-49, 391, 437  
    diagram, 50  
    flow chart, 56  
    requirements, 192, 391-393  
Established ground surface, 51, 137, 190, 197-198, 250, 267, 269  
Examination, 93, 118, 119, 131  
Exploratory boring, 2, 38, 78, 83, 108, 179, 455-458  
Explosives, 106, 276, 327

## **F**

Federal property, 84  
Feeding or watering area, 307, 319  
Feedlot (see Animal feedlot)  
Fee  
    electronic (FAX) payment, 96  
    exemptions, 92-93, 166  
    late license or registration renewal, 94  
    refund, 93-96, 98, 120, 128, 142, 147, 156, 440  
    requirements, 92-96  
    summary, 157

Fertilizer, 32, 190, 247, 303-305, 307, 321  
Fill in well or boring, 229, 272-275  
Filter sand (see Gravel pack)  
Flood areas, 71, 191, 297-299, 339, 362  
Flood protection, 297-299, 362  
Flooding (see Regional flood)  
Floor drain, 73, 74, 191, 310, 311, 314, 316, 318, 362  
Flowing well or boring, 249-259  
Flowing well or boring special construction area, 250-252, 257-259  
Flow control required, 255  
Flow measurement, 482-485  
Flush threaded casing, 373-374  
Footing drain, 74, 310  
Formation, 27, 492-498  
French drain (see Gravel pocket)  
Frost-proof yard hydrant, 86, 109, 317

## G

Gases, 38, 53, 60, 75, 185, 187-189, 190, 338  
Gas pipe, 187-189  
Gas storage “well,” 459-461  
Geological materials, 154, 172, 173-176  
Geologic column, southeast Minnesota, 498  
Geothermal, 311, 317, 385, 504-506  
Glacial drift (see Unconsolidated materials)  
Glacial outwash (see Unconsolidated materials)  
Glacial till (see Unconsolidated materials)  
Government fee exemption (expired), 92  
Grade A dairy, 85  
Granite, 174  
Granular bentonite (see Bentonite, granular)  
Grave, 308  
Gravel pack, 180, 181, 211, 212-213, 225-226, 235-236, 327, 370  
Gravel pocket, 190, 312, 317, 362  
Grease trap (see Interceptor)  
Green area (at-grade), 366, 380-381  
Gray-water, 73, 310, 312  
Ground surface (see Established ground surface)  
Groundwater  
    definition, 51  
    in Minnesota, 492-497  
    thermal exchange device, 51-52, 148-151, 437, 458-459  
Grout  
    basket, 222  
    definition, 52  
    density, 37, 39, 58  
    pipe (see Tremie pipe)  
    pump, 223, 237  
    settlement, 236-237  
Grouting  
    bedrock, 229-235  
    below screen, 229  
    between casings, 228  
    caverns and grout loss, 235

- collapsing formations, 222
- completion, 222
- confining layer, 238
- cuttings, 225-226
- depth requirement, 225-227
- materials, 219-222
- methods, 222-224
- plastic casing, 209-210, 238
- pouring, 223
- set times (see Grouting, wait on cement)
- summary, 238-239
- temporary casing, 226, 229
- tremie pipe, 76, 196, 223, 237
- unconsolidated formations, 225-227
- wait on cement, 225
- when driving casing, 228-229

## **H**

- “H” number (sealing), 169
- Hand pump, 197, 244
- Hazardous substance, 52, 304, 306, 310
- Hazardous waste, 52-53, 77, 312
- Health risk limits (HRLs), 589-602
- Heat loops (see Vertical heat exchanger)
- Heat pumps (see Groundwater thermal exchange device)
- High early cement (see Cement, rapid setting)
- Highest flood, 362
- Hoist, 45-46, 53, 89, 96, 124, 127-128, 455
- Holding tank, 53, 308, 318
- Horizontal heat exchanger (geothermal loop), 153, 311, 317, 385, 388, 504-506
- Horizontal trenches, 71, 365
- Household waste, 302, 311
- Hydrants (see Frost-proof yard hydrant)
- Hydraulic conductivity, 34, 40-41, 44, 48, 51, 180, 185
- Hydraulic cylinder, 47, 95, 110, 389-390
- Hydrofracturing, 53, 106, 185, 215, 341-343
- Hydrogen sulfide, 75, 190, 338, 339
- Hydropneumatic tank (see Pressure tank)

## **I**

- Infectious wastes, 304, 314
- Igneous rocks, 35, 71, 176, 229, 341-342
- Inclinometer, 48, 391, 393
- Individual well contractor, 54, 93, 110, 111-113, 118, 121, 123, 125
- Injection, 51-52, 95, 148-151, 185, 266
- Inner casing, 196-197, 198, 480
- Inspection, 86, 88, 92, 361, 439
- Interceptor (sewer), 54, 308
- Internet, 143, 144
- In-well treatment, 71, 106-107, 265
- Irrigation well, 290, 292, 301, 321, 327, 329, 333-335
- Isolation distances for wells and borings
  - buildings, 192
  - electric lines, 187-189

- gas pipes, 187-189
- LP tanks, 187-189
- Isolation distances for water-supply wells
  - animal confinement summary, 306
  - between two wells, 309, 318
  - buildings, 189-192
  - contamination sources, 301-326
  - doubling the distance, 318-320
  - exceptions, 301, 318, 321
  - no longer in use, 302, 318
  - not required, 318
  - pollutant or contaminant, 310
  - petroleum tank summary, 309
  - sealed well, 309
  - sensitive wells, 318-320
  - surface water, 297-299
  - summary, 323-326
  - when contamination is removed, 318
- Inspection, 88

## **J**

- J plug, 376

## **K**

- Kennel, 316, 319

## **L**

- Label (see Well, label)
- Lake, 215, 216, 297
- Landfill, 302, 303, 319
- Landspreading (waste) area, 319
- Law (Chapter 103I), 1-3, 31, 83, 84, 436-462
- Leaching pit, 30, 72, 307
- Lead, 211, 212, 329, 578
- Lead packer, 211, 212, 329
- Leader pipe, 211, 213, 275, 276
- License/registration
  - advisory council review, 118
  - application, 111, 119-120
  - application procedure summary, 131-132
  - bond, 85-86, 89, 94, 109, 120-121, 133-134, 386, 451
  - card, 127-129
  - continuing education, 125-126
  - decals, 127-129
  - disciplinary action, 123-124
  - elevator contractor, 110
  - examination, 119, 131
  - exceptions, 105, 107-108
  - experience, 113-118
  - experience outside Minnesota, 118
  - expiration, 121-122
  - fee, 93-94, 120, 122, 131-135
  - individual, 110-112
  - late renewal, 121-122

- limited well contractor, 109-110
- loss of certified representative, 112-113
- monitoring well contractor, 110, 114-115
- number, 127
- property owner exemption, 105
- qualification application, 93, 111
- reapplication, 124
- reciprocity 118, 451
- renewal, 121-122
- repair, 106
- representative, 111-113
- required, 105-111
- revocation, 124
- summary, 130, 133-135
- supervision, 112-117, 443
- well contractor, 108-109
- year, 121-122
- Licensee, 54, 87, 112
- Lift station, 73, 309
- Limestone, 174, 175, 209, 213, 228, 229, 238, 239, 290-296
- Limited well/boring contractor
  - certification qualifications, 115-118
  - definition, 54-55
  - license renewal, 121-122
  - license suspension, 123-124
  - representative, 111-113, 115-117
  - requirement, 109-110
- Liners, 173, 196, 275
- Liquid propane (LP) tank, 187-189
- Local well programs (see Delegated local programs),
- Location of wells, 187-192, 297-298, 301-326, 361-362
- Lost circulation materials, 70, 405

## M

- Maintenance of wells, 87, 153, 260, 266-267
- Maintenance permit
  - application, 163-165
  - dewatering well, 165
  - fee, 95, 97, 157
  - monitoring well, 164-165
  - required, 162-163, 270-271
  - water-supply well, 164
- Man hole vault, 35, 106, 381-383, 425
- Manure, 32,
  - lagoon or basin, 55, 303, 305, 306, 319
  - storage area, 55, 305, 319
- Maximum contaminant levels, 283, 589-602
- Measurement reporting, 137
- Metamorphic rocks, 35, 71, 176, 229, 342
- Methane, 75, 190
- Military reservations, 82, 92, 144
- Mineral exploration drilling, 48, 83, 179, 441
- Minimum casing depth, 327
- Minimum casing diameter, 197

Minnesota Department of Health (MDH), 1, 3, 44, 88, 464, 465  
     district map and phone numbers, 464  
 Minnesota Department of Natural Resources (DNR), 44, 52, 71, 78, 84, 255, 297, 370, 465  
 Minnesota Geological Survey (MGS), 171, 282, 291, 465  
 Minnesota Pollution Control Agency (MPCA), 31, 32, 44, 51, 52, 55, 78, 85, 148, 185, 216, 282, 465  
 Monitoring well  
     access agreement, 146  
     amended permit, 145  
     at-grade, 35, 74, 106, 141, 142, 143, 144, 146-147, 158, 188, 244, 366, 369, 375, 377, 380-383, 392  
     bentonite pellets, 235, 375  
     cap, 376-377  
     change of status, 138, 144  
     construction, 179  
     contractor registration, 110, 114-115, 119-120  
     cuttings, 375  
     damage repair, 380  
     definition, 55, 438  
     drilling fluids, 375  
     driven casing, 46, 196, 198, 226,  
     flow chart, 56  
     flush threaded casing, 193, 194, 204, 205, 243, 365, 373-374  
     grouting, 375  
     maintenance permit, 162-165  
     manhole vault, 35, 106, 381-383, 425  
     permit, 143-47  
     permit fee, 95, 97  
     permit exemption, 144  
     protection, 376-379  
     sealing, 380  
     special construction requirements, 373-375  
     temporary, 144, 145-146, 170, 171  
     use, 373  
 Motor fuel retail outlet, 55, 74, 97, 145, 164, 444  
 Mound (sewage), 31, 53, 74, 302, 302, 308  
 Mud balance, 37, 58, 222  
 Multi-aquifer well (see Aquifer interconnection)  
 Multiple casings in one bore hole, 196, 198, 226, 275, 393  
 Municipal sewer (see Sewer)

## N

NSF, 81, 206, 207, 216, 242, 244, 265, 332, 338, 341, 347, 397-408  
 NSF 60 and 61 (see ANSI/NSF 60 and 61)  
 Native American reservations, 82, 94, 144  
 Neat-cement grout, 57-58, 196, 197, 198, 210, 219-220, 225, 228, 229, 231, 235, 239, 250-251, 256, 278,  
     279-280, 281, 292, 293, 299, 375, 377, 386, 390, 393  
     bentonite mixture, 57-58, 219-220  
     definition, 57-58  
 Nitrate, 351-354, 578, 583, 585-587  
 Noncommunity public water supply, 58-59, 67-68, 86, 108, 138, 357-360  
 Nonpotable, 66-67, 260, 292, 327, 329-330, 351, 363, 430  
 Notification  
     change of contractor, 141  
     conversion, 138, 144  
     dewatering well, 142-143, 158-160

drivepoint well, 165-167  
emergency, 158-160  
exception, 92-93  
fee, 94-95, 137, 140-142  
refund, 93  
requirements, 137-143, 152-153  
transfer, 154, 163  
unsuccessful well, 140, 160-161, 442-443  
water-supply well, 139-142  
well sealing, 152-153

## O

Offset well casing, 198  
Oil lubricated turbine pump, 244-245  
“Old” contamination sources, 302, 318  
Open hole, 38, 210, 211, 213, 275, 293, 366, 367, 375, 393  
Ordinary high-water level, 59, 297-298, 313  
Out-of-water, 138  
Outwash, 35, 36, 76, 251  
Owner (well or boring), 55, 74, 84, 87-88, 94-95, 108, 137, 139-155, 159, 163, 165-166, 170, 260, 261

## P

Packer, 53, 208, 211, 212, 222, 272-273, 276, 329, 339, 341, 342  
Pasture, 51, 59, 307, 319,  
PCB, 217, 272, 283, 595  
Pearock, 235, 280  
Peat, 41, 48, 391  
Peat filter, 311  
Perforation, 273-276  
Permit  
    approval, 161  
    conversion, 144  
    denial, 161-162  
    elevator, 155-156  
    emergency, 158-160  
    exception, 158  
    fee, 156-157  
    groundwater thermal exchange device, 148-151  
    maintenance, 162-165  
    monitoring well, 143-147  
    motor fuel retail outlet, 145, 164, 444  
    petroleum bulk storage site, 95, 145, 147, 164  
    refund, 93  
    requirements, 153-160, 161-165  
    transfer, 138, 147, 163  
    unsuccessful well or boring, 160-161  
    vertical heat exchanger, 153-154  
Person, 40, 54, 59, 67, 71, 85, 87, 88, 90, 91, 105, 137, 438  
Pesticide, 32, 190, 247, 265, 303, 305, 307, 347  
Petroleum  
    bulk storage site, 60, 95, 145, 147, 164  
    definition, 59-60  
    motor fuel retail outlet, 64, 95  
    pipeline, 307



- piping, 311
- storage, 60, 78, 95, 304, 306
- summary, 309
- tank, 304, 306, 309, 314, 325, 361
- Piezometer, 47, 48, 144, 260, 391
- Pipeline, 60, 307
- Pipeline terminal, refinery, 60, 307
- Pit, 39, 45, 105, 269, 285, 313, 318, 361, 390
- Pit pipe, 196, 199, 209
- Pitcher pump, 244, 333
- Pitless adapter or unit, 53, 54, 60-62, 106, 109, 116, 15, 198, 206, 241-243, 255, 267, 331-332, 333, 338
  - approved list, 422-423
- Placard, 188-189
- Planning and zoning officials, 470-475
- Plan review
  - public well, 265, 357, 359-361
  - special construction area, 261-262, 507
- Plant amendment, 32, 247, 303, 304
- Plastic casing (see Casing, plastic),
- Plumbing, 54, 66, 85-86, 107, 108, 109, 246, 248, 291, 315-316, 334, 337-338, 429-435
- Pollution, 48, 63-65, 85, 388, 392
- Pollution Control Agency (see Minnesota Pollution Control Agency),
- Pond, 248, 297, 317
- Pool, swimming, 313, 347
- Portland cement, 38-39, 40, 57-58, 66, 70, 80, 280
- Potable water, 53, 66, 77, 85, 143, 185, 215, 327
- Potable water-supply well, 66-67, 291
- Potable water pipe markings, 66-67, 330
- Power lines (see Electric lines)
- Precode wells or borings, 266, 268-269
- Pressure tank, 67, 79, 86, 109, 248, 267, 337, 338-339
  - approved list, 424
  - ASME rated, 67
  - buried tank, 339
  - public well, 360
- Priming, 67, 185, 333
- Privy, 308, 317, 319
- Professional engineer (PE), 114, 360
- Propane tank, 187-189
- Property location, 490-491
- Property owner, 87, 94, 95, 99, 102, 105, 137, 139, 146, 159, 165-167, 260, 266, 286, 444, 445, 447
- Property owner exemption, 87, 165
- Public water supply
  - community, 40, 67-68, 86, 108, 137, 138, 317, 340, 357-359
  - connection required, 363
  - conversion, 359
  - definition, 67-68
  - examples, 68
  - grouting, 358
  - noncommunity, 58-59, 67-68, 86, 108, 138, 357-359
  - notification, 357
  - operator, 108
  - special construction requirements, 357-363
- Pulled well, 167, 267, 275, 278,

## Pump

- column, 245
- discharge line, 337-338, 363
- hoist (see Hoist)
- oil lubricated, 244-245
- PCB, 272, 283
- priming (see Priming)
- rod, 244, 272
- room (see Building, well or boring located in)

## Pumping

- equipment, 40, 53, 54, 75, 79, 106, 107, 108, 109, 110, 116, 158, 244-245, 270, 333, 345, 365, 439
- test, 55, 107
- water level, 68-69

## **Q**

- Qualification application, 93, 111
- Quarry, 78, 83, 318, 438

## **R**

- Radial water collector, 362-363
- Railroad track, 35, 381
- Rapid setting cement (see Cement, rapid setting)
- Record, well or boring, 39, 54, 112, 144, 160, 169-175, 285, 342, 380, 444
- Recovery well (see Remedial well)
- Redi-mix concrete, 280
- Reduced Pressure Zone backflow preventer (RPZ), 150, 246, 247, 248, 387, 432, 433
- Refinery, 307
- Refund (see Fee, refund)
- Regional flood, 71, 256, 299, 339, 340, 376-377
- Registered professional engineer (PE), 114, 360, 443
- Registrant, 39, 71, 87, 89, 90, 91, 105, 111, 112, 118-123, 152, 386
- Registration (also see Licensing/registration)
  - drilling machine and hoist, 45-46, 53, 95-96, 127-129, 455
  - monitoring well contractor (see Monitoring well, contractor registration)
- Regolith, 36, 51, 174, 229
- Remedial well, 2, 35, 45, 71, 77, 83, 85, 106, 107, 138, 147, 193, 213, 215, 289, 290, 293, 339, 348, 365-367
- Repair of wells or borings, 2, 87, 105, 108, 158, 266-269
- Replacement well or boring, 92, 210, 266
- Representative, 39, 111-113
- Reservation (see Native American and military)
- River, 207, 313
- Rock, (also see Bedrock), 34, 35, 36, 41, 45, 71, 174-176, 229, 273
- Rotary, 45, 145, 225, 275, 358
- Rule
  - applicability, 2, 83-88, 105-108, 179, 289, 355, 357, 359, 365, 369, 373, 385, 389, 391, 437, 439, 442
  - explanation, 2
  - part, 2
  - repealed, 33

## **S**

- Safeguards, 303, 304, 305, 306, 307, 309, 321, 444
- Salt storage, 311
- Sampling devices, 79, 107, 365

Sand  
 definition, 71, 173  
 fill, 272,  
 in potable wells, 211, 328  
 in thermal grout, 386-387  
 use in grout, 36, 39, 40, 220, 221, 222  
 use in sealing, 278, 279, 280

Sandpoint (see Drivepoint)

Sandstone, 35-36, 175, 181, 228, 229, 231, 272, 274, 275, 279, 291, 292

Sanitary landfill (see Landfill)

Sanitary seal, 200, 241, 423

Scientific notation, 34

Scrap yard, 72, 311

Screen, 53, 54, 72, 106-107, 116, 166-167, 180, 196, 211-212  
 leader or riser, 72, 196, 211-212  
 sump, 72

Screened vent, 340, 339-341, 423

Screening a contact, 238, 293, 367, 375, 393

SDR (see Standard dimension ratio)

Sealed well with no sealing record, 501

Sealing  
 bedrock, 279  
 caverns and grout loss, 270-280  
 cisterns, 285  
 collapse, 272, 273  
 contamination removal and reporting, 282-283  
 definition, 72, 270  
 debris, 272-273  
 dewatering well, 369, 370-371  
 drivepoint, 165, 166, 167  
 dug well, 270, 273, 279, 280  
 fee, 93, 270  
 flowing well or boring, 281  
 inaccessible well or boring, 285  
 in delegated program areas, 86, 271, 467-469  
 large diameter well or boring, 279, 280  
 liability, 285  
 licensing and registration, 133-135, 270  
 local authority, 271  
 notification, 152-153, 270  
 not in use well or boring, 95, 162-165, 270, 283, 286, 443, 444  
 obstructions, 272-273  
 partial, 230  
 perforation, 273-277  
 preparation, 282  
 “pulling” drive-point, 275, 278  
 record, 169-173, 281, 285, 501  
 regulation, 271  
 reporting unsealed well or boring, 286  
 required, 270-271  
 requirements, 270-287  
 responsibility, 286-287  
 “telescoped” casing, 275  
 unconsolidated materials, 278

- unlocated well, 284-285
- unsuccessful well, 286
- water testing prior to sealing, 282
- well pit, 285
- who may seal, 270
- Sediment in potable water-supply wells, 327-328
- Seepage bed (see Soil dispersal system)
- Seepage pit, 40, 72, 307, 319
- Sensitive water-supply well (see Water supply-well, sensitive)
- Septic tank, 72, 73, 308
- Setback (see Isolation distance)
- Sewage
  - definition, 73
  - landspreading, 319
  - lift station, 73, 309
  - mound, 31, 74, 302, 304, 308
  - sump, 73, 308-309, 313
- Sewer
  - collector, 310, 314, 315
  - definition, 73-74
  - municipal, 85, 310, 314
  - not buried, 310
  - single-family, 314
  - storm, 74-75, 297, 311, 313, 316
  - testing, 314-316
- Shale, 35, 175, 181, 274, 291
- Shale trap, 222
- Shallow well, 318
- Silo, 318
- Single motor fuel retail outlet, 74, 95, 145, 444
- Slab (concrete), 197-198, 244, 362
- Sludge, 53, 77, 311, 319
- Slug test, 185
- Soil amendment, 32, 247, 303, 304
- Soil classification, 80, 173
- Soil dispersal system, 74, 301, 302, 304, 308
- Solvent cement, 207-209
- Sparge point, 48, 393
- Spark arrester, 365
- Special well and boring construction areas, 261-263, 507-573
- Spring, 78, 493
- Stabilization pond (see Waste stabilization pond)
- Stabilization test, 107
- Standard Dimension Ratio (SDR), 205
- Standards, 79-81
- Standing column well, 51, 148, 504
- State agencies, 84-86, 465
- Static water level, 74, 172, 212, 235, 291-293
- Statutes (see Law)
- Steel casing (see Casing, steel)
- Storm water drain pipe (see Sewer, storm)
- Stream, 297, 313
- Subcontracting, 91, 112, 140
- Submersible pumps, 283, 337, 338

Subsurface disposal system, 74  
Subterranean gas, 75  
Suction line, 75, 333-336, 337-338  
Sump, 45, 71, 72, 73, 211, 212-213, 308-309, 313, 365, 369, 434-435  
Superfund, 84, 92, 140, 144  
Supervision, 112, 113, 114, 115, 116, 117  
Surface casing, 195-196, 209, 226  
Swimming pool, 313, 318

## T

Tank basin, 48, 51  
Telephone wires, 188  
Temporary  
    cap, 199, 241  
    casing (see Casing, temporary)  
    monitoring well, 144, 145-146, 170, 171  
    well, 45, 78, 144, 145-146, 152, 170, 171, 194, 256, 270  
Test  
    holes or wells, 48, 140, 270, 359, 391  
    pumping, 216-217,  
    sewer (see Sewer, test)  
Thermal exchange device (see Groundwater thermal exchange device)  
Township, range, section, 99, 141, 143, 146, 149, 152, 154, 155, 172, 490-491  
Total coliform bacteria, 76, 345, 351-353, 579-584  
Transfer of notification or permit (see Notification, or Permit, transfer)  
Treatment chemicals, 81, 185, 190, 191, 216-217, 265-266  
Tremie pipe, 53, 76, 196, 223, 235, 236-237, 278, 280  
Trenches, 31, 71, 74, 153, 302, 308, 337, 385, 505  
Turbine pump (see Vertical turbine pump)

## U

Unconsolidated materials, 34, 35-36, 76, 173, 180, 197, 211, 219, 221, 225-226, 228, 239, 275, 278, 279  
Unfilled space, 313  
Unique number, 169, 171  
United States land office grid system, 490-491  
Unsuccessful well or boring, 140, 160-161, 194, 270, 286, 442  
Unused well or boring, 271, 286, 287, 499-503

## V

Vacuum release, 337  
Vapor recovery, 48, 391, 437  
Variance  
    application, 98-101, 102, 103  
    delegated program, 101  
    emergency, 100  
    fee, 98  
    process, 101  
    rules, 98-104, 427-428  
    summary, 102-104  
Vent  
    casing, 241, 340, 339-341, 423  
    environmental bore hole, 243, 333  
    pressure tank, 338  
Vertical heat exchanger, 77, 179, 385-388, 438, 459, 505-506

Vertical turbine pump, 185, 244-245  
Violation of the rules, 89-92  
Volume  
    between two casings or casing and open hole, 477-479  
    of casing or hole, 476

## W

“W” number, 169  
Waste interceptor (see Interceptor)  
Wastewater  
    spray irrigation, 305, 319  
    stabilization pond, 303, 305  
    treatment plant, 307  
    unit, 77, 307, 309  
Water  
    bearing layer, 47-48, 437  
    calculations, conversion factors, 485-488  
    conditioning devices, 106-108  
    discharge line, 86, 107, 109, 337-338  
    flow measurement 482-485  
    level, 45, 47, 48, 59, 68-69, 71, 74, 140, 172, 212, 291-293, 297-298, 313  
    quality standards (see Health risk limits)  
    sample, 342, 345, 346, 350-354  
    sampling devices, 107, 365  
    service pipe or line (see water, discharge line)  
    table, 34, 78, 293, 317, 338, 366, 374, 424, 492  
    tanks, 79  
    testing (see Water, sample)  
    treatment chemicals (see Treatment chemicals)  
    treatment chemical discharge, 216-217, 265-266  
Water-supply well  
    construction, 289-367  
    definition, 77-78  
    disinfection, 345-350  
    isolation distances, 297, 301-326  
    minimum depth, 327  
    notification, 139-142  
    priming, 333  
    public, 357-363  
    sensitive, 73, 318-320  
    venting, 339-341  
Web site (see internet)  
Weighting agents, 216, 281, 405  
Well  
    advisory area (see Special well and boring construction area)  
    cap (see Casing, cap or cover)  
    contractor license (see License, well contractor)  
    cuttings (see Cuttings)  
    definition, 78  
    development (see Development)  
    disclosure (see Disclosure of wells at property transfer)  
    drilling machine (see Drilling, machine)  
    exempt from regulations, 83-84, 179, 189, 250, 262, 293, 348, 366, 367, 369, 370, 373  
    house (see Building, well located in)

injection (see Injection)  
interference, 370  
in use, 78, 163, 164, 165, 270, 283, 284, 286, 373, 438  
label, 141, 260, 382  
location, 187-192, 297-298, 301-326, 342, 361-363  
maintenance permit, 162-165  
minimum depth, 327  
not in use, 95, 162-164, 165, 270, 283, 284, 286, 370, 373, 392  
on property of another, 87, 137, 444  
owner, 46, 55, 74, 87, 90-91, 94-95, 99, 105, 108, 139, 146, 152, 161, 166, 1760, 260, 261, 266, 270, 286, 328, 351, 353, 362, 380, 442-447, 449  
pit, 75, 105, 198, 269, 285  
pump or pumping equipment, 54, 79, 106, 107, 109, 110  
record (see Record, well or boring)  
repair (see Repair of wells or borings)  
seal (see Sanitary seal)  
sealing (see Sealing)  
sealing notification (see Sealing, notification)  
special construction areas (see Special well and boring construction areas)  
tag (see Well, label)  
vent (see vent, casing)  
Wentworth particle size, 173  
Wetland, 59, 216, 297, 311

## X

## Y

Yard hydrant, 86, 109, 317, 361  
Yield, 34, 48, 53, 78, 106, 107, 139, 265, 328, 341, 391, 492-497

## Z

## TABLE OF CONTENTS RULES HANDBOOK

Introduction.....	1
Subject Index .....	4
Table of Contents.....	23
General, Definitions	
General .....	31
Definitions .....	31
Incorporations by Reference and Abbreviations .....	79
Applicability, Enforcement, Fees, Variance	
Application to all Wells and Borings .....	83
Enforcement .....	89
Fees Applicable to this Chapter.....	92
Variance.....	98
Licensing, Registration, Certification	
Activities Requiring Licensure or Registration .....	105
Certified Representative or Individual Well Contractor.....	111
Experience Requirements; Certified Representative and Individual Well Contractor .....	113
Council Evaluation of Applicants .....	118
Examination.....	119
Application for Licensure or Registration.....	119
Bonding .....	120
License or Registration Renewal.....	121
Certification Renewal.....	122
Disciplinary Action: Return of Documents.....	123
Reapplication after Certification, License, or Registration Revocation .....	124
Continuing Education Requirements.....	125
Criteria for Continuing Education .....	126
Advisory Council Review of Continuing Education Programs.....	127
Placement of Decals and License or Registration Number .....	127
Drilling Machine and Hoist Registration .....	127
Permits and Notifications	
Permits and Notifications, General.....	137
Notification for Construction of Water-Supply Wells .....	139
Dewatering Well Construction Notification.....	142
Monitoring Well Construction Permit.....	143
Groundwater Thermal Exchange Device Permits .....	148
Notification for Well Sealing .....	152
Vertical Heat Exchanger Construction Permits.....	153
Elevator Boring Construction Permits.....	155
Notification and Permit Fees .....	156
Exception to Notification and Permit Requirements .....	158
Emergency Notifications and Permits .....	158
Unsuccessful Completion of a Well or Boring.....	160
Approval of Construction Permits.....	161
Denial of Construction Permit Application .....	161
Well Maintenance Permits .....	162
Property Owner or Lessee Drive-Point Water-Supply Well Construction Notification .....	165



Records, Samples	
Well and Boring Records .....	169
Cutting Formation Samples .....	176
Aquifers, Disposal	
Applicability .....	179
Interconnection of Aquifers Prohibited .....	179
Use of Wells or Borings for Disposal or Injection Prohibited.....	185
Utilities, Buildings	
Required Distance from Gas Pipes, Liquid Propane Tanks, and Electric Lines .....	187
Location of Well or Boring Within Building .....	189
Distance from a Building.....	192
Casing	
General Casing Requirements .....	193
Steel Casing Requirements.....	200
Plastic Casing and Coupling Requirements .....	204
Plastic Casing Installation .....	207
Screens, Drilling Fluids	
Screens; Screen Leaders, Risers, and Sumps .....	211
Gravel Packs .....	212
Drilling Fluids .....	215
Disposal of Materials.....	216
Grouting	
Grouting.....	219
Connections, Pumps	
Casing Connections and Caps .....	241
Pumps and Pumping Equipment .....	244
Interconnections and Cross Connections.....	245
Flowing Wells and Borings, Label	
Flowing Well or Boring .....	249
Well Label .....	260
Special Construction Areas	
Requirements for Designated Special Well and Boring Construction Areas .....	261
Treatment, Repair, Sealing	
Chemical Treatment and Rehabilitation .....	265
Repair, Correction, or Sealing of Wells and Borings .....	266
Sealing Well or Boring.....	270
Responsibility for Sealing .....	286
Water-Supply Wells, Limestone, Flooding	
Applicability .....	289
Bentonite Drilling Fluids.....	289
Limestone or Dolomite Water-Supply Wells .....	290
Water-Supply Well Distance from Water Bodies; Protections in Flood Areas.....	297
Isolation Distances	
Water-Supply Well Distances from Contamination Source.....	301
Minimum Depth, Sediment, Lead, Nonpotable	
Minimum Protective Depth .....	327
Sediment in Potable Water-Supply Wells .....	327
Lead Prohibition in Potable Water-Supply Wells .....	329
Nonpotable Water-Supply Wells.....	329

Pitless, Pumps, Vents, Hydrofracturing	
Water-Supply Well Pitless Adapter or Pitless Unit, and Welded or Threaded Fitting.....	331
Priming Water-Supply Well Pumps .....	333
Water-Supply Well Suction Line .....	333
Water-Supply Well Pump Discharge Lines.....	337
Pressure Tanks for Water-Supply Wells .....	338
Venting Water-Supply Wells .....	339
Hydrofracturing Water-Supply Wells .....	341
Disinfection, Water Sample	
Water-Supply Well Disinfection .....	345
Water Quality Samples from Newly Constructed Potable Water-Supply Well .....	350
Dug Wells	
Dug Water-Supply Wells .....	355
Public Wells	
Public Water-Supply Wells .....	357
Community Public Water-Supply Wells .....	359
Remedial Wells	
Remedial Water-Supply Wells .....	365
Dewatering Wells	
Dewatering Well.....	369
Monitoring Wells	
Applicability and Use .....	373
Construction of Monitoring Wells.....	373
Protection of Monitoring Wells.....	376
Repair; Sealing of Monitoring Well .....	380
At-Grade Monitoring Well .....	380
Vertical Heat Exchangers	
Vertical Heat Exchangers .....	385
Elevator Borings	
Elevator Borings.....	389
Environmental Bore Holes	
Environmental Bore Holes .....	391
Appendix: Index, Materials	
Appendices Index .....	395
ANSI/NSF Std. 60 Drilling Aids and Sealants.....	397
Foams, Weighting Agents, Lost Circulation Materials .....	405
ANSI/NSF Std. 60 Cleaning and Rehabilitation Aids.....	406
FIFRA Registered Chlorine Products.....	409
Pitless Adapters and Units.....	422
Buried Pressure Tanks .....	424
At-Grade Manholes and Vaults .....	425
Appendix: Rules, Law	
Chapter 4717: Variance Rules.....	427
Chapter 4715: Plumbing Code .....	429
Chapter 103I: Wells, Borings, and Underground Uses .....	436

Appendix: Information

Abbreviations .....	463
Minnesota Department of Health District Map and Phone Numbers .....	464
State Agency Phone Numbers and Web Sites .....	465
Groundwater Related Contacts.....	466
Delegated Well Programs.....	467
County Planning and Zoning Officials.....	470
Volume of Casing, Hole, or Annular Space .....	476
Casing Combinations and Pipe Schedules .....	480
Flow Calculations.....	482
Conversion Factors.....	486
Property Location .....	490
Groundwater, Geology .....	492
Disclosure and Well Sealing .....	499
Geothermal .....	504
Special Well and Boring Construction Areas.....	507
Water Quality .....	574

**MINNESOTA RULES, CHAPTER 4725**  
**DEPARTMENT OF HEALTH**  
**WELLS AND BORINGS**  
**AUGUST 4, 2008**

- 4725.0050 General.
- 4725.0100 Definitions.
- 4725.0150 Incorporations by Reference and Abbreviations.
- 4725.0200 Application to all Wells and Borings.
- 4725.0250 Enforcement.
- 4725.0350 Fees Applicable to this Chapter.
- 4725.0410 Variance.

**LICENSING AND REGISTRATION**

- 4725.0475 Activities Requiring Licensure or Registration.
- 4725.0550 Certified Representative or Individual Well Contractor.
- 4725.0650 Experience Requirements; Certified Representative and Individual Well Contractor.
- 4725.0900 Council Evaluation of Applicants.
- 4725.1025 Examination.
- 4725.1075 Application for Licensure or Registration.
- 4725.1250 Bonding.
- 4725.1300 License or Registration Renewal.
- 4725.1310 Certification Renewal.
- 4725.1500 Disciplinary Action; Return of Documents.
- 4725.1600 Reapplication After Certification, License, or Registration Revocation.
- 4725.1650 Continuing Education Requirements.
- 4725.1675 Criteria for Continuing Education.
- 4725.1685 Advisory Council Review of Continuing Education Programs.
- 4725.1700 Placement of Decals and License or Registration Number.
- 4725.1800 Drilling Machine and Hoist Registration.

**PERMITS AND NOTIFICATIONS**

- 4725.1810 Permits and Notifications, General.
- 4725.1820 Notification for Construction of Water-Supply Wells.
- 4725.1825 Dewatering Well Construction Notification.
- 4725.1830 Monitoring Well Construction Permit.
- 4725.1831 Groundwater Thermal Exchange Device Permits.
- 4725.1832 Notification for Well Sealing.
- 4725.1833 Vertical Heat Exchanger Construction Permits.
- 4725.1835 Elevator Boring Construction Permits.
- 4725.1836 Notification and Permit Fees.
- 4725.1837 Exception to Notification and Permit Requirements.
- 4725.1838 Emergency Notifications and Permits.
- 4725.1840 Unsuccessful Completion of a Well or Boring.
- 4725.1842 Approval or Construction Permits.
- 4725.1845 Denial of Construction Permit Application.
- 4725.1848 Well Maintenance Permits.

- 4725.1849 Property Owner or Lessee Drive-Point Water-Supply Well Construction Notification.
- 4725.1851 Well and Boring Records.
- 4725.1855 Cutting Formation Samples.

## **WELL AND BORING GENERAL CONSTRUCTION AND USE REQUIREMENTS**

- 4725.2010 Applicability.
- 4725.2020 Interconnection of Aquifers Prohibited.
- 4725.2050 Use of Wells or Borings for Disposal or Injection Prohibited.
- 4725.2150 Required Distance from Gas Pipes, Liquid Propane Tanks, and Electric Lines.
- 4725.2175 Location of Well or Boring Within Building.
- 4725.2185 Distance from a Building.
- 4725.2250 General Casing Requirements.
- 4725.2350 Steel Casing Requirements.
- 4725.2550 Plastic Casing and Coupling Requirements.
- 4725.2650 Plastic Casing Installation.
- 4725.2750 Screens; Screen Leaders, Risers, and Sumps.
- 4725.2850 Gravel Packs.
- 4725.2950 Drilling Fluids.
- 4725.2975 Disposal of Materials.
- 4725.3050 Grouting.
- 4725.3150 Casing Connections and Caps.
- 4725.3250 Pumps and Pumping Equipment.
- 4725.3350 Interconnections and Cross Connections.
- 4725.3450 Flowing Well or Boring.
- 4725.3550 Well Label.
- 4725.3650 Special Well and Boring Construction Areas.
- 4725.3725 Chemical Treatment and Rehabilitation.
- 4725.3750 Repair, Correction, or Sealing of Wells and Borings.
- 4725.3850 Sealing Well or Boring.
- 4725.3875 Responsibility for Sealing.

## **WATER-SUPPLY WELLS**

- 4725.4050 Applicability.
- 4725.4150 Bentonite Drilling Fluids.
- 4725.4250 Limestone or Dolomite Water-Supply Wells.
- 4725.4350 Water-Supply Well Distance from Water Bodies; Protections in Flood Areas.
- 4725.4450 Water-Supply Well Distances from Contamination.
- 4725.4550 Minimum Protective Depth.
- 4725.4650 Sediment in Potable Water-Supply Wells.
- 4725.4750 Lead Prohibition in Potable Water-Supply Wells.
- 4725.4825 Nonpotable Water-Supply Wells.
- 4725.4850 Water-Supply Well Pitless Adapter or Pitless Unit, and Welded or Threaded Fitting.
- 4725.5050 Priming Water-Supply Well Pumps.
- 4725.5150 Water-Supply Well Suction Line.
- 4725.5250 Water-Supply Well Pump Discharge Lines.
- 4725.5350 Pressure Tanks for Water-Supply Wells.
- 4725.5450 Venting Water-Supply Wells.
- 4725.5475 Hydrofracturing Water-Supply Wells.
- 4725.5550 Water-Supply Well Disinfection.

4725.5650 Water Quality Samples from Newly Constructed Potable Water-Supply Well.  
4725.5750 Dug Water-Supply Wells.  
4725.5825 Public Water-Supply Wells.  
4725.5850 Community Public Water-Supply Wells.  
4725.6050 Remedial Water-Supply Wells.

### **DEWATERING WELLS**

4725.6150 Dewatering Well.

### **MONITORING WELLS**

4725.6450 Applicability and Use.  
4725.6650 Construction of Monitoring Wells.  
4725.6755 Protection of Monitoring Wells.  
4725.6775 Repair; Sealing of Monitoring Well.  
4725.6850 At-Grade Monitoring Well.

### **VERTICAL HEAT EXCHANGERS**

4725.7050 Vertical Heat Exchangers.

### **ELEVATOR BORINGS**

4725.7250 Elevator Borings.

### **ENVIRONMENTAL BORE HOLES**

4725.7450 Environmental Bore Holes.

**End  
of  
Introduction Section**

## **4725.0050 GENERAL.**

*This chapter is adopted according to and must be read in conjunction with Minnesota Statutes, chapter 103I, relating to wells, borings, and underground uses.*

A copy of Minnesota Statutes, Chapter 103I (2008), is reproduced in the appendix. Current copies may be referenced at many libraries, online at [www.leg.state.mn.us/leg/statutes.asp](http://www.leg.state.mn.us/leg/statutes.asp), or at the MDH.

Minnesota Statutes, Chapter 103I, is a state law passed by the Minnesota Legislature and signed by the governor. It defines many of the terms related to wells and borings, and gives the MDH the responsibility and authority to regulate well and boring construction and sealing, license contractors, and make rules.

*STAT AUTH: MS s 103I.101; 103I.221; 103I.301; 103I.621; 144.05; 144.12; 144.383; 157.04; 157.08; 157.09; 157.13*

*HIST: 17 SR 2773*

## **4725.0100 DEFINITIONS.**

*Subpart 1. Scope. Terms used in this chapter that are defined in Minnesota Statutes, section 103I.005, have the meanings given in statute. For the purposes of this chapter, the terms defined in this part have the meanings given them.*

A rule generally must not repeat language in statute. Definitions in statute, which are officially referenced in rule, have been repeated in this handbook for ease of reading. Some additional definitions from statute have also been included. Definitions in statute supersede definitions in rule. Supplementary rule definitions clarify or complement statutory definitions.

A copy of Minnesota Statutes, Chapter 103I, is included in the appendix.

*Subpart 1a. Absorption area. “Absorption area” has the meaning in part 7080.1100, subpart 2, as proposed in State Register, Volume 31, Number 33, page 1025, published on February 12, 2007, and not yet adopted, and includes the area of soil designed to absorb sewage effluent.*

Minnesota Rules, Chapter 7080 are the rules relating of the Minnesota Pollution Control Agency (MPCA). Relating to subsurface sewage treatment systems.

“**Absorption area**” is essentially the soil beneath and next to a septic system that treats sewage. The technical definition is found in Minnesota Rules, part 7080.1100, subpart 2, that defines “absorption area” as the design parameter that is associated with the hydraulic acceptance of effluent. The absorption area for mound systems is the original soil below a mound system that is designed to absorb sewage tank effluent. The absorption area for trenches, seepage beds, and at-grade systems is the soil area in contact with the part of the distribution medium that is designed and loaded to allow absorption of sewage tank effluent. This includes both bottom and sidewall soil contact areas.



***Subp. 1b. Agricultural chemical. “Agricultural chemical” has the meaning in Minnesota Statutes, section 18D.01, subdivision 3.***

“**Agricultural chemical**” is defined in Minnesota Statutes, section 18D.01, subdivision 3, to mean a pesticide as defined under section 18B or a fertilizer, agricultural liming material, plant amendment, or soil amendment as defined under Chapter 18C. “Pesticide” is defined as “. . . a substance or mixture” of substances intended to prevent, destroy, repel, or mitigate a pest, and a substance or mixture of substances intended for use as a plant regulator, defoliant, or desiccant.” Most pesticides used in Minnesota agriculture are herbicides (weed killers).

***Subp. 1c. Animal unit. “Animal unit” has the meaning in part 7020.0300, subpart 5, and is a unit of measure comparing the production of animal manure. One animal unit is equal to one slaughter steer, one horse, or for animals not listed in part 7020.0300, subpart 5, the average weight of the animal in pounds divided by 1000.***

Minnesota Rules, Chapter 7020 are the feedlot rules of the MPCA.

“**Animal unit**” is used in the isolation distance section as a way to measure the amount of animal manure produced, to establish setback distances. In general, 1,000 pounds of animal(s) equals one animal unit.

“**Animal unit**” is defined in Minnesota Rules, part 7020.0300, subpart 5 to mean a unit of measure used to compare differences in the production of animal manure that employs as a standard the amount of manure produced on a regular basis by a slaughter steer or heifer for an animal feedlot or a manure storage area, calculated by multiplying the number of animals of each type in items A to I by the respective multiplication factor and summing the resulting values for the total number of animal units. For purposes of this chapter, the following multiplication factors shall apply:

A. Dairy Cattle:

- (1) One mature cow (whether milked or dry);
  - (a) Over 1,000 pounds, 1.4 animal unit; or
  - (b) Under 1,000 pounds, 1.0 animal unit;
- (2) One heifer, 0.7 animal unit; and
- (3) One calf, 0.2 animal unit;

B. Beef Cattle:

- (1) One slaughter steer or stock cow, 1.0 animal unit;
- (2) One feeder cattle (stocker or backgrounding) or heifer, 0.7 animal unit;
- (3) One cow and calf pair, 1.2 animal unit; and
- (4) One calf, 0.2 animal unit;

C. One Head of Swine:

- (1) Over 300 pounds, 0.4 animal unit;
- (2) Between 55 pounds and 300 pounds, 0.3 animal unit; and
- (3) Under 55 pounds, 0.05 animal unit;

D. One Horse, 1.0 animal unit;

E. One Sheep or Lamb, 0.1 animal unit;

- F. Chickens:
  - (1) One laying hen or broiler, if the facility has a liquid manure system, 0.033 animal unit; or
  - (2) One chicken if the facility has a dry manure system:
    - (a) Over 5 pounds, 0.005 animal unit; or
    - (b) Under 5 pounds, 0.003 animal unit;
- G. One Turkey:
  - (1) Over 5 pounds, 0.018 animal unit; or
  - (2) Under 5 pounds, 0.005 animal unit;
- H. One Duck, 0.01 animal unit; and
- I. For animals not listed in items A to H, the number of animal units is the average weight of the animal in pounds divided by 1,000 pounds.

*Subp. 2. [Repealed, 15 SR 78]*

The regulations relating to well construction were first codified on July 15, 1974, as MHD 210 – 230. Subsequent revisions have renumbered the rules as 7MCAR 1.210 – 1.224, and currently as Chapter 4725. The rules have been amended since 1974 with language added, modified, or deleted. Language that is new in the 2008 version is not highlighted in any way. In order to determine which rules have been added or modified, it is necessary to compare the current rules with past rules or to obtain the hearing record.

The rules do indicate if an entire rule part or subpart has been repealed. “Repealed, 15 SR 78” means that the entire rule subpart (in this case a definition of “Act,” referring to the previous well law which was itself repealed) was repealed in a previous revision of the rules. The first number refers to the volume of the *State Register* where the official notice was printed, and the second number is the first page).

*Subp. 3. [Repealed, 15 SR 78]*

*Subp. 4. [Repealed, 17 SR 2773]*

*Subp. 5. [Repealed, 17 SR 2773]*

*Subp. 6. [Repealed, 15 SR 78]*

*Subp. 7. [Repealed, 15 SR 78]*

*Subp. 8. [Repealed, 17 SR 2773]*

*Subp. 9. [Repealed, 17 SR 2773]*

*Subp. 10. [Repealed, 17 SR 2773]*

*Subp. 11. [Repealed, 17 SR 2773]*

*Subp. 12. [Repealed, 17 SR 2773]*

*Subp. 13. [Repealed, 17 SR 2773]*

*Subp. 14. [Repealed, 17 SR 2773]*

*Subp. 15. [Repealed, 15 SR 78]*

*Subp. 16. [Repealed, 15 SR 78]*

*Subp. 17. [Repealed, 17 SR 2773]*

*Subp. 18. [Repealed, 15 SR 78]*

*Subp. 19. **Annular space.** “Annular space” means the space between two cylindrical objects one of which surrounds the other, such as the space between a bore hole and a casing pipe, or between a casing pipe and liner pipe.*

Tables of the annular volume between two casings, or between a casing and an open hole; and a table of the annular volumes between two steel casings are located in the appendix.

*Subp. 20. [Repealed, 17 SR 2773]*

*Subp. 21. **Aquifer.** “Aquifer” means a stratum of saturated, permeable bedrock or unconsolidated material having a recognizable water table or potentiometric surface which is capable of producing water to supply a well.*

The definition of an “**aquifer**” is based on water transmission properties, not geologic lithology. An aquifer may be a single geologic formation, a number of geologic formations, or a portion of a formation. An aquifer is a body of rock or soil which exhibits a recognizable water table or potentiometric surface. In general, hydraulic conductivities of aquifers exceed  $10^{-6}$  cm/sec and sustained yields exceed .25 gallons per minute. Desirable yields for domestic supply should exceed 10 gallons per minute; however the rules do not require a well to yield a minimum amount of water.

An aquifer must have open spaces to store water, and interconnection of the spaces to transmit water. Water storage is sometimes referred to as “porosity” and water transmission sometimes referred to as “permeability.” Storage and transmission may be through primary pores, such as the space between sand grains in sandstone, or through secondary spaces such as fractures in granite. Geologic materials with primary porosity comprising aquifers are typically sands, gravels, and sandstones. Geologic materials with secondary porosity comprising aquifers are materials such as fractured granite and quartzite, and partly dissolved (karsted) limestone. Geologic materials that are commonly not good aquifers (confining layers) are clays, shales, and nonfractured igneous rocks such as granite.

Scientific notation is used in various portions of the rules and the rule explanation. A preceding paragraph references a  $10^{-6}$  cm/sec hydraulic conductivity value.  $10^{-6}$  is scientific notation for 10 to the negative 6 power, which is equal to  $1/10^6$ , or in decimal form 0.000001.  $10^6$  means that 10 is multiplied by itself 6 times, equaling 1,000,000, or 1 million.

The appendix contains a generalized state geologic map, a hydrogeologic column for southeastern Minnesota, and a discussion about aquifers in the state.

**Subp. 21a. At-grade.** *“At-grade” means the termination of a well or boring at the established ground surface.*

The rules allow a monitoring well, environmental bore hole, remedial well, or dewatering well to terminate **“at-grade”** only in locations where termination of the casing above-grade presents a serious danger to vehicular or pedestrian traffic. Every effort should be made to terminate the casing above-grade. At-grade wells present problems of sampling, contamination through a leaking vault, and paving or building over the well. At-grade casings are not allowed on nonvehicular areas such as boulevards or other “green” areas. Termination “at-grade” means that the top of the casing terminates at an elevation equal to the ground surface elevation surrounding the concrete pad. A concrete pad with an approved vault must be installed so that the vault cover is at least 2 inches above the surrounding grade. The concrete pad or apron must slope away from the casing in all directions to prevent surface contaminants from washing into the casing.

At-grade termination is allowed within 8-1/2 feet of the centerline of a railroad track per Minnesota Statutes, section 219.50.

A diagram of typical at-grade construction is included with the at-grade requirements in Minnesota Rules, part 4725.6850.

**Subp. 21b. Bedrock.** *“Bedrock” means a consolidated or coherent, hard, naturally formed aggregation of rock in the earth. Bedrock includes geologic materials deposited prior to the Cretaceous geologic period, and includes igneous and metamorphic rock such as granite, basalt, and iron formation, and sedimentary rock including sandstone, limestone, and shale. Bedrock includes sandstone formations such as the St. Peter or Jordan that may be semi-consolidated. Bedrock does not include alluvium, glacial drift, glacial outwash, glacial till, saprolite, or soil. For the purposes of these rules, bedrock does not include mineral matter deposited during, or more recently than, the Cretaceous geologic period, or weathered portions of the formation surface where more than 50 percent of the parent bedrock is altered to an unconsolidated state.*

**“Bedrock”** includes geologic materials deposited in ancient seas (sedimentary bedrock) or geologic materials resulting from volcanic activity or molten magma (volcanic or igneous rock). Most bedrock in Minnesota is hundreds of millions years old. Metamorphic bedrock is sedimentary, igneous, or volcanic rock that has been subject to intense pressures and temperatures. Unconsolidated materials in Minnesota were largely deposited by glaciers. Most unconsolidated materials in Minnesota are less than 1 million years old.

The distinction between bedrock and unconsolidated formations in these rules is not based on the hardness or cohesiveness of the unit. Some glacial tills with large percentages of gravel may drill harder and slower than sandstone such as the St. Peter. Nevertheless, the till is considered an unconsolidated deposit and the St. Peter is considered bedrock. The distinction is based on deposition and age. In general, most Minnesota bedrock, particularly sedimentary bedrock, extends laterally for much greater distances, and is more homogenous than unconsolidated materials. Some sandstone bedrock, such as the St. Peter or

Jordan formations may be loosely cemented. Even though these formations may appear soft when drilled, they are considered bedrock, and wells and borings in these formations must follow the bedrock rule requirements.

The **Cretaceous** geologic period ended 65 million years ago. Cretaceous deposits largely occur in scattered locations in western Minnesota and are frequently discontinuous. Many Cretaceous deposits are unconsolidated or loosely consolidated similar to glacial deposits or saprolite. “Saprolite” is a term used to describe a clay, silt, or other weathering horizon on bedrock. For the purposes of the rules, “bedrock” does not include mineral matter deposited during the Cretaceous period (145 to 66 million years ago) or after the Cretaceous period. This excludes the Cretaceous deposits predominately found in western Minnesota, the glacial deposits of the Pleistocene, and recent alluvium. Bedrock also does not include regolith or **weathered portions of rock**, where less than 50 percent of the parent rock remains.

Alluvium, glacial drift, glacial outwash, and glacial till are unconsolidated materials.

*Subp. 21c. **Bentonite.** “Bentonite” means an aluminum silicate clay that contains at least 85 percent of the mineral montmorillonite and meets API specification 13A-04.*

**Bentonite** is a natural mineral comprised predominately of the clay montmorillonite. Bentonite is a clay formed from the decomposition of volcanic ash. Wyoming is a major producer of bentonite. Bentonite has the unique ability to absorb water and expand, sometimes over ten times its original volume. This ability to swell is useful for drilling and sealing.

Additives to the bentonite such as pozzolan, hydrocarbons, or other hazardous materials are prohibited. Additives are allowed if they meet the NSF Standard 60. In addition to “pure” bentonites, bentonites meeting NSF Standard 60 may also be used.

High-yield (drilling mud) bentonites are fine-ground bentonites with high swelling capabilities. These products are designed for use as drilling fluids containing approximately 6 percent bentonite. They are not suitable for grout because the mixtures become too viscous to pump before 15 percent solids have been added.

*Subp. 21d. **Bentonite grout.** “Bentonite grout” means water and a minimum of 15 percent by weight of powdered or granular bentonite, with no additives to promote temporary viscosity. An additional 15 percent by weight of either washed sand or cuttings taken from the bore hole may be mixed into the bentonite and water slurry. The bentonite must be designated by the manufacturer as a grout or well and boring sealant, and must be mixed in accordance with the manufacturer’s specifications.*

**Bentonite grout** must contain a minimum of 15 percent bentonite (but may contain more) and may also contain up to 15 percent of sand or cuttings taken from the bore hole. The sand or cuttings must be mixed with the bentonite slurry and both pumped into the space to be grouted from the bottom up through the casing or a tremie pipe.

The bentonite must be designated by the manufacturer as a bore hole grout or sealant. Bentonite manufactured for other uses such as feed additives, waterproofing, or even drilling fluid is not allowed. The manufacturer’s mixing specifications must be followed. If the manufacturer’s specification establishes a minimum 30 percent bentonite solids grout, the product may not be mixed to a 15 percent solids content. Should a manufacturer’s instructions call for less than 15 percent solids, it may not be used. It is recommended that whenever possible, higher bentonite percentages be used. Products are available which contain 30 percent and more solids.

Granular bentonite means a uniform-sized coarse ground, less than 1/8-inch diameter (at least 95 percent passing a 4 mesh screen) bentonite, containing at least 85 percent of the mineral montmorillonite. Products commonly sold as pellets or chips are not granular bentonite.

Bentonite/cement grouts, except for the provision that allows up to 5 percent bentonite in neat cement, may not be used. The addition of even moderate amounts of cement to bentonite grout results in a mixture that is not rigid like cement grout, or flexible like bentonite grout, and has some of the worst characteristics of both materials – high permeability, low strength, and low swelling capacity.

Drilling fluid bentonite left in the bore hole is not considered a grout. Bentonite-based drilling fluids contain typically 3 to 7 percent bentonite. The rules require a minimum of 15 percent bentonite for bentonite grout. High yield drilling fluid bentonites, and even some bentonite grouts, when they are mixed with a high shear pump or mixing system, may be difficult or impossible to mix to the required quantity of bentonite.

The 2008 rule revision combined the two previously allowed bentonite-based grouts, “bentonite grout” and “high-solids bentonite grout,” into a single standard, and now refers to the grout material as “bentonite grout.”

### **BENTONITE GROUT FORMULA**

- 50 pounds of bentonite (1 sack), and
- 283 pounds of water (34 gallons); or
- Approximately 1.5 lbs. bentonite to 1 gallon water

### **DENSITY**

Bentonite grout (or other grout) mixtures can be verified to meet the rules by the use of a mud balance. A specified quantity of the grout is weighed, which results in a bulk density. Approximate densities are as follows:

Fluid	Density
● Water	- 8.3 lbs/gal
● Drilling mud (6 percent bentonite and water)	- 8.6 lbs/gal
● 15 percent bentonite without sand or cuttings	- 9.1 lbs/gal
● 15 percent bentonite and 15 percent sand	- 10.6 lbs/gal
● 30 percent bentonite and water	- 9.9 lbs/gal

*Subp. 21e. **Boring.** “Boring” has the meaning given in Minnesota Statutes, section 103I.005, subdivision 2, and includes environmental bore holes, vertical heat exchangers, and elevator borings, except that for the purposes of this chapter, “boring” does not include exploratory borings regulated under chapter 4727.*

“**Boring**” is defined in Minnesota Statutes, Chapter 103I, to mean a hole or excavation that is not used to extract water and includes exploratory borings, environmental bore holes, vertical heat exchangers, and elevator borings. In this rule, the term “boring” does not include exploratory borings.

*Subp. 22. **Casing.** “Casing” means a pipe or curbing placed in a well or boring to:*

- A. prevent the bore hole walls from caving;*
- B. seal off surface drainage; or*
- C. prevent gas, water, or other fluids from entering the well or boring except through the screen, open hole, or perforated casing.*

The standards for casing are found in Minnesota Rules, parts 4725.2250 through 4725.2650, and Minnesota Rules, part 4725.6650.

*Subp. 22a. **Casing vent.** “Casing vent” means an outlet at the upper terminal of a casing, cap, or cover to allow equalization of air pressure in the casing and escape of toxic or flammable gases when present.*

The standards for casing vents are found in Minnesota Rules, parts 4725.5450 (water-supply wells) and 4725.5850 (community water-supply wells).

*Subp. 22b. **Cement-sand grout.** “Cement-sand grout” means a fluid mixture of Portland cement, sand, and water in the proportion of 94 pounds of Portland cement, not more than 1.0 cubic foot of dry sand, and not more than six gallons of water. Admixtures to reduce permeability or control setting time must meet ASTM Standard C494/C494M-04.*

Chemical admixtures to reduce permeability or control setting time must meet **American Society for Testing and Materials (ASTM) Standard C494/C494M-04**. “Superplasticizers” for geothermal or other applications to improve flowability or reduce water requirements may be used if they meet ASTM C494 and ANSI/NSF Standard 60. Normally, Type I or IA Portland cement without admixtures or bentonite is used for routine grouting.

## CEMENT-SAND GROUT FORMULA

- 94 pounds of Portland cement;
- Not more than 6 gallons of water; and
- Not more than 1.0 cubic foot of sand.

Some manufacturers are supplying Portland cement in 42 kilogram (92.6 pound bags). The formula for cement-sand grout remains 94 pounds of Portland cement with not more than 6 gallons of water and not more than 1.0 cubic foot of sand. The formula for the 42 kilogram bags is:

- 42 kilograms (92.6 pounds) of Portland cement;
- Not more than 5 gallons and 117 fluid ounces of water (11 ounces less than a gallon); and
- Not more than 1702 cubic inches of sand (26 cubic inches less than 1 cubic foot).

One cubic foot of sand weighs between 90 and 120 pounds depending on the size, material, moisture content and packing. For purposes of calculation, 105 pounds is commonly used.

## ONE CUBIC YARD OF CEMENT-SAND GROUT

	BY VOLUME	BY WEIGHT (lbs.)
Portland Cement	13.5 (94 lb.) bags	1269
Washed Sand	13.5 cubic feet	1418
Water	81 gallons	676
	-----	-----
Yield	1 cu. Yard	3363 lbs.

**The cement-sand grout will weigh approximately 125 lbs./cu. ft. or 16.6 lbs./gallon.**

***Subp. 22c. Certified representative. “Certified representative” has the meaning given in Minnesota Statutes, section 1031.005, subdivision 2a, and means a human being who acts on behalf of a licensee or registrant.***

The “**certified representative**” is the human being who has the necessary experience, passes the exam(s), takes the continuing education, signs the permits and records, is the primary contact between the MDH and the licensee or registrant, and is responsible for the activities of the licensee or registrant. The certified representative is not the licensee or registrant who is typically a business organization such as corporation or partnership.

***Subp. 23. Cesspool. “Cesspool” means an underground pit into which raw household sewage or other untreated liquid waste is discharged and from which the liquid seeps into the surrounding soil.***



A **cesspool** is different from a seepage pit, leaching pit, or dry well in that raw sewage directly enters a cesspool and exits largely untreated into the surrounding soil. Sewage enters, and is partially treated in a septic tank prior to entering a seepage pit, leaching pit, or dry well. A cesspool is commonly a concrete or steel tank with perforations, or a concrete block structure with openings between the blocks and/or in the bottom. Cesspools are not allowed for new construction. However, some still are in use or have not been properly abandoned.

**Subp. 23a. Community water system.** “Community water system” has the meaning given in Code of Federal Regulations, title 40, section 141.2, and means a public water system which serves at least 15 service connections used by year-round residents, or regularly serves at least 25 year-round residents.

Examples include: cities, mobile home parks, housing developments, apartment buildings, and extended health care facilities providing piped water.

**Subp. 23b. Completion of work.** “Completion of work” means the date on which the installation of the pump or pumping equipment is finished, the date on which construction of the well or boring is completed if a pump or pumping equipment is not installed by the person constructing the well or boring, the date that construction work regulated by this chapter is completed, the date the well or boring is put into service, or the date that the permit or notification expires, whichever occurs first.

**Subp. 23c. Concrete.** “Concrete” means a mixture of Portland cement, sand and gravel aggregate, and water so that one cubic yard of concrete contains a minimum of 470 pounds (five 94-pound bags) of Portland cement, a maximum of 30 gallons of water, and sand and gravel aggregate passing a one-inch sieve. Admixtures to reduce permeability or control setting time must meet ASTM Standard C494/C494M-04.

Fly-ash or other unapproved additives are not allowed. Concrete is only approved for sealing certain large diameter wells and borings, see Minnesota Rules, part 4725.3850.

**Subp. 24. [Repealed, 17 SR 2773]**

**Subp. 24a. Confining layer.** “Confining layer” means a stratum of a geologic material that restricts vertical water movement. A confining layer includes:

A. a stratum at least ten feet in vertical thickness of unconsolidated materials or bedrock, that has a vertical hydraulic conductivity of  $10^{-6}$  centimeters per second or less;

B. a stratum at least ten feet in vertical thickness of clay, sandy clay, or silty clay as defined by the United States Department of Agriculture in Handbook 18; or,

*C. a stratum at least ten feet in vertical thickness of the St. Lawrence or Eau Claire sedimentary bedrock formation, or a stratum at least two feet in vertical thickness of the Decorah or Glenwood sedimentary bedrock formation, as described in “Geology of Minnesota: A Centennial Volume “by Sims P. K. and Morey, G.B., pages 459-473, “Paleozoic Lithostratigraphy of Southeastern Minnesota” by George Austin, which is incorporated by reference. The publication is available at the Minnesota Geological Survey, Minnesota Department of Health, or through the Minitex interlibrary loan program.*

The term “**confining layer**” is used in Minnesota Rules, parts 4725.2020, 4725.3050, 4725.3450, and 4725.3850. Sedimentary Paleozoic rock confining units of southeastern Minnesota are identified in this definition. Layers less than 10 feet thick, except for the Decorah and Glenwood formations, are not considered confining layers for the purposes of these rules. Peat and muck swamp deposits are not considered confining layers.

A geologic column, which indicates Paleozoic sedimentary confining layers of southeastern Minnesota, is included in the appendix.

### **HYDRAULIC CONDUCTIVITY**

“**Hydraulic conductivity**” is the capacity of a porous medium to transmit a fluid. Specifically, it is the rate of flow of water through a unit cross-sectional area under a unit hydraulic gradient. Very good water-producing aquifers such as gravels and karsted limestone typically have hydraulic conductivities of  $10^2$  to  $10^2$  centimeters per second (cm/sec). Sand aquifers typically have hydraulic conductivities of 1 to  $10^4$  cm/sec. Hydraulic conductivities of glacial till can range from  $10^{-3}$  to  $10^{-10}$  cm/sec. A measured hydraulic conductivity of the Decorah Shale confining layer is  $1.2 \times 10^{-9}$  and the Eau Claire confining layer is  $5.5 \times 10^{-8}$  cm/sec. Hydraulic conductivities may be reported in units other than cm/sec:

- One foot/day =  $3.5 \times 10^{-4}$  cm/sec.
- One gallon per day per foot squared =  $4.72 \times 10^{-5}$  cm/sec.
- One meter/day =  $1.16 \times 10^{-3}$  cm/sec.

### **CLAY**

The U. S. Department of Agriculture defines “**clay**” to include mineral particles smaller than .002 millimeters. A “clay” soil is defined as soil that contains 40 percent or more clay, less than 45 percent sand, and less than 40 percent silt. “Sandy clay” is defined as soil material that contains 35 percent or more of clay and 45 percent more of sand. “Silty clay” is defined as soil material that contains 40 percent or more clay and 40 percent or more silt. For the purposes of the rules, silty clay and sandy clay are considered clay.

Clay is a fine-textured geologic material that usually forms very hard lumps or clods that are hard when dry. When the moist material is pinched out between the thumb and fingers, it will form a long, flexible “ribbon.” However, some fine clays very high in colloids are friable and lack plasticity (they will not form a ribbon).

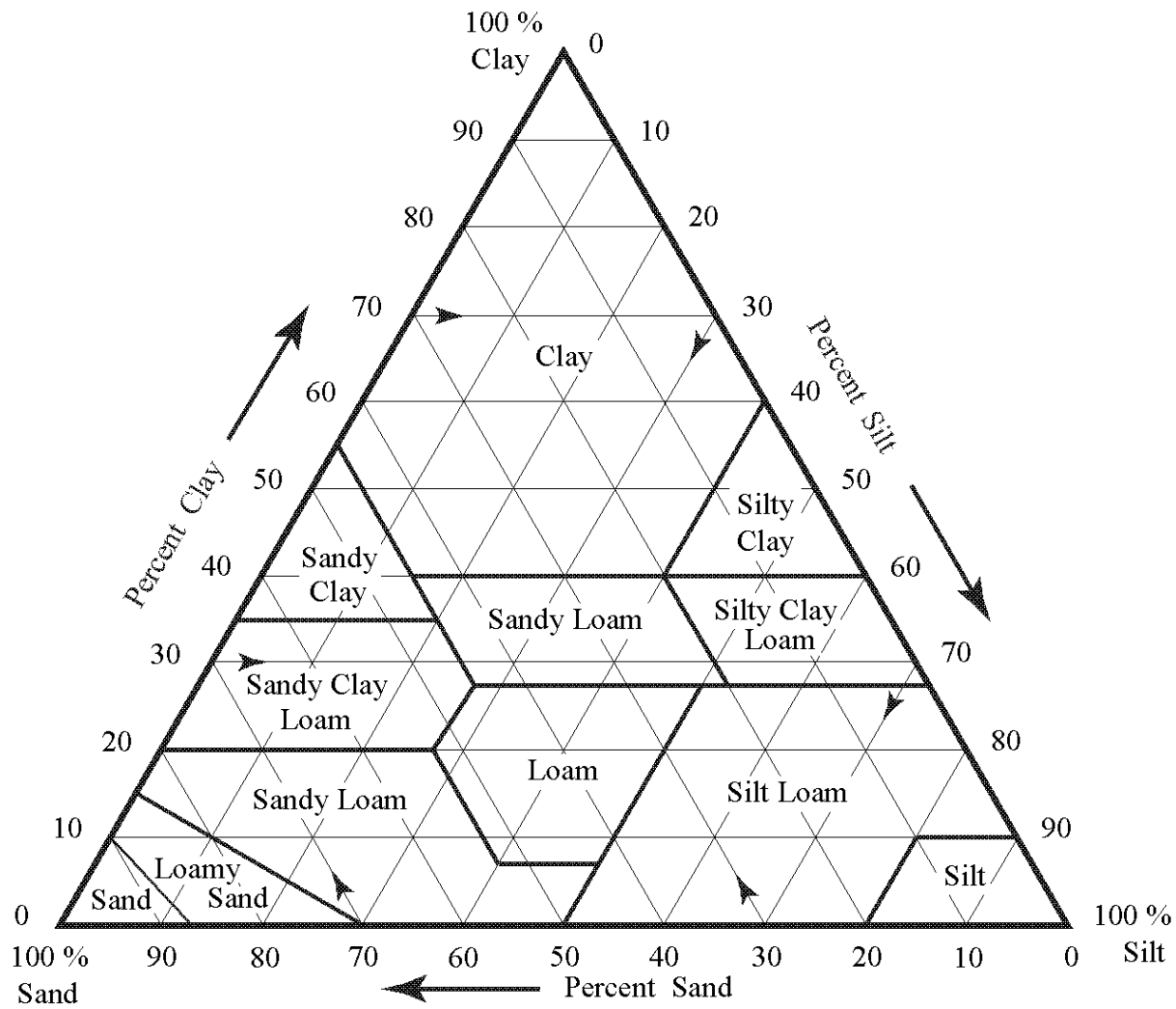

Figure 1. U.S.D.A. Soil Classification

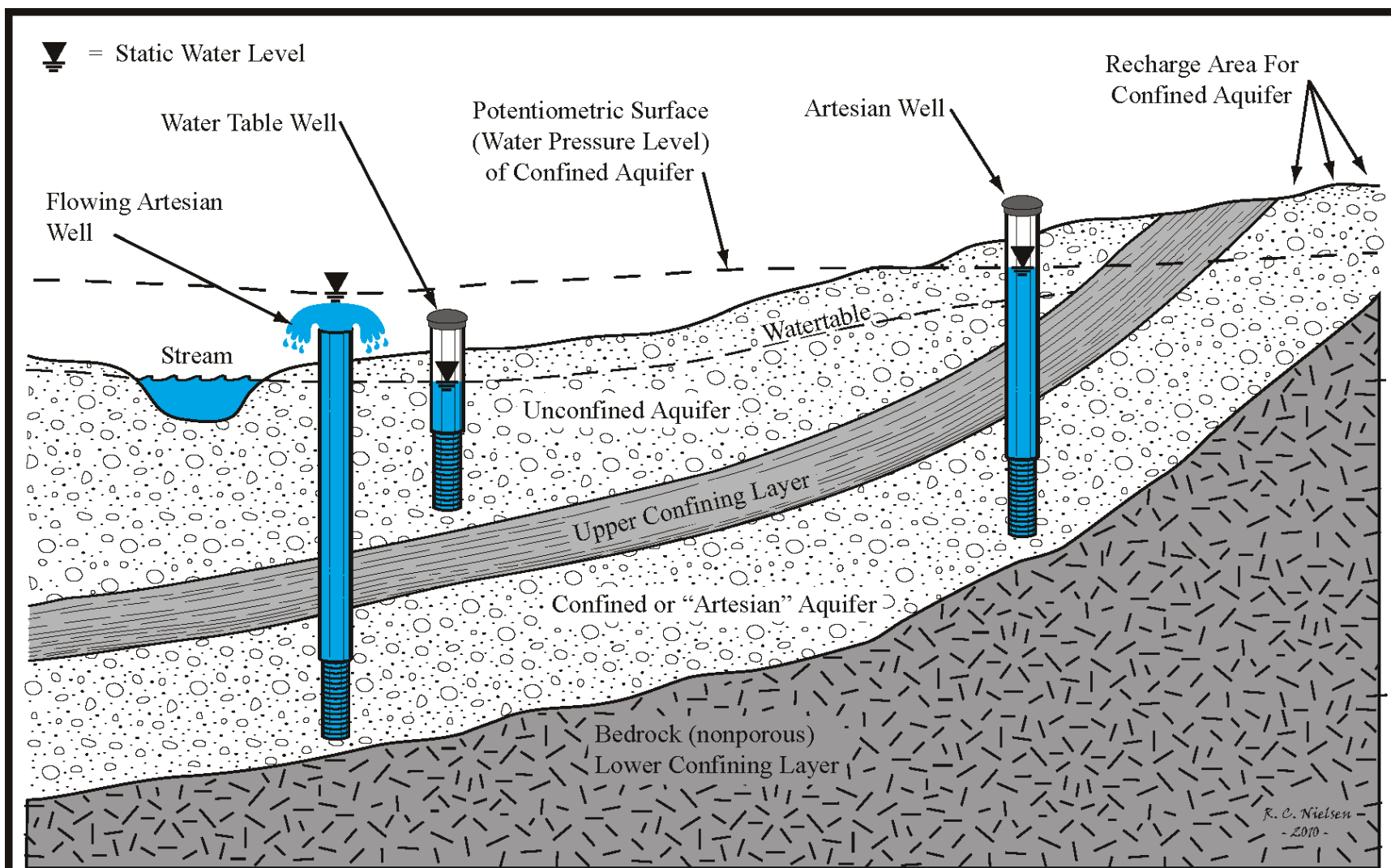

Figure 2. Terms Relating to Confined Aquifers

**Subp. 24b. Confining materials.** “Confining materials” means geologic materials that restrict vertical water movement. Confining materials include:

A. unconsolidated material or bedrock that has a vertical hydraulic conductivity of  $10^{-6}$  centimeters per second or less;

B. clay, sandy clay, or silty clay as defined by the United States Department of Agriculture in Handbook 18 which is incorporate by reference; or

C. the Decorah, Glenwood, St. Lawrence, or Eau Claire sedimentary bedrock formations, as described in “Geology of Minnesota: A Centennial Volume “ by Sims P. K. and Morey, G.B., pages 459-473, “Paleozoic Lithostratigraphy of Southeastern Minnesota” by George Austin, which is incorporated by reference.

The term “**confining material**” has a definition very similar to “confining layer” except for the thickness component. The term “confining material” is used in the definition of “sensitive well.” The isolation distance rules require a “sensitive” water-supply well to be located twice as far from sources of contamination entering the soil. A sensitive well is one that has less than 50 feet of casing or does not penetrate a 10-foot confining layer or multiple layers of confining materials with an aggregate thickness of 10 feet or more. In other words, two or more layers of clay less than 10 feet thick, that together add up to 10 feet, are considered to protect the well from surface contaminants and therefore the distances to contamination sources do not have to be doubled.

**Subp. 24c. Contact hour.** “Contact hour” means a minimum of 50 minutes of lecture, demonstration, workshop, or training excluding coffee breaks, registration, meals, or social activities.

Six contact hours of MDH-approved continuing education must be obtained each year for each certified representative of a monitoring well contractor, well contractor, or an individual well contractor. Two of the six hours must be from a MDH-presented or -sponsored program. Two contact hours of continuing education must be obtained by each certified representative of a limited well/boring contractor or an elevator contractor, and the two hours must be from a MDH-presented or sponsored program. The criteria for continuing education are found in Minnesota Rules, parts 4725.1650 through 4725.1685. A full calendar of continuing education activities is posted on the MDH Well Management Section Web site at [www.health.state.mn.us/divs/eh/wells/lwcinfo/training.html](http://www.health.state.mn.us/divs/eh/wells/lwcinfo/training.html).

**Subp. 24d. Council.** “Council” means the Advisory Council on Wells and Borings created under Minnesota Statutes, chapter 103I.

The advisory council consists of 18 voting members: six certified representatives of licensed well contractors, six government representatives (MPCA, Minnesota Department of Natural Resources (DNR), Minnesota Geological Survey, Board of Water and Soil Resources, Minnesota Department of Transportation (MnDOT), MDH), two public members, one licensed explorer, one monitoring well contractor, one vertical heat exchanger contractor, and one elevator contractor. The members serve four-year terms. Industry and public members are appointed by the commissioner of health. Agency members are appointed by the head of their respective agency. The council meets approximately four times a year and provides review of license applicants, assistance with examinations, rule review, product review, policy recommendations, and technical expertise.

*Subp. 24e. **Cuttings.** “Cuttings” means a mixture of drilling fluid, ground up rock, and unconsolidated material removed from a well or boring.*

Cuttings include only the natural geologic materials removed from the well or boring and do not include gravel pack, borrow soil, or other materials.

*Subp. 24f. **Dewatering well.** “Dewatering well” has the meaning given in Minnesota Statutes, section 103I.005, subdivision 4a. Dewatering well includes a temporary well for construction dewatering greater than 25 feet deep, and permanent dewatering wells. “Dewatering well” does not include:*

- A. a well 25 feet or less in depth for temporary construction dewatering;*
- B. a well used to lower groundwater levels for control or removal of groundwater contamination regulated as a remedial well; or*
- C. a drain tile, perforated pipe, sump, or pit less than ten feet deep, or less than ten feet below the floor of a basement, used to lower groundwater levels for construction or use of underground space.*

Minnesota Statutes, Chapter 103I defines “**dewatering well**” as a nonpotable well used to lower groundwater levels to allow for construction or use of underground space. A dewatering well does **not** include:

- A “well” or dewatering “well” 25 feet or less in depth for temporary dewatering during construction (permanent dewatering wells, or dewatering wells for purposes other than construction are regulated even if the wells are less than 25 feet deep);
- A well used to lower groundwater levels for control or removal of groundwater contamination (these are remedial wells, and are regulated even if the wells are less than 25 feet deep); or
- An excavation less than 10-feet deep.

*Subp. 24g. **Dewatering well contractor.** “Dewatering well contractor” means a person issued a limited well/boring contractor’s license to construct, repair, and seal dewatering wells.*

*Subp. 25. [Repealed, 15 SR 78]*

*Subp. 26. [Repealed, 17 SR 2773]*

*Subp. 26a. **Drilling machine.** “Drilling machine” means a motorized machine or mechanical device mounted on a truck, trailer, crawler, or skid used to excavate, drill, or bore a well or boring. A drilling machine includes a cable tool, hollow rod, auger, or rotary tool.*

Minnesota Statutes, section 103I.545 requires that **drilling machines (and hoists)** used for an activity, which requires a license or registration must be registered annually. The annual registration fee is \$75 for each machine. The rule exempts small drilling machines, which are not mounted on a truck, trailer or skid

from the registration requirement. Exempted equipment includes hand casing drivers, chain hoists, tripods, and hand jetting tools. **Nondrilling machines or hoists**, such as water trucks, grout pumps, air compressors, and other support vehicles are not required to be registered, and will not be registered by the MDH.

Well drilling machines and pump hoists registered under Minnesota Statutes, Chapter 103I are exempted from Minnesota motor vehicle registration taxes (license plates) by Minnesota Statutes, section 168.012, subdivision 5. The Minnesota Department of Public Safety (DPS) or the Minnesota State Patrol should be consulted for clarification or further information.

***Subp. 26b. Drive-point well. “Drive-point well” has the meaning given in Minnesota Statutes, section 103I.005, subdivision 5.***

Minnesota Statutes, Chapter 103I, defines “**drive-point well**” to mean a well constructed by forcing a pointed well screen, attached to sections of pipe, into the ground with the screen and casing forced or driven into the ground with a hammer, maul, or weight. Drive-point wells may be installed by a property owner for domestic or agricultural purposes. The requirements of these rules must be followed including the contamination source separation distances, the 15-foot-minimum casing requirement, the requirement to terminate the casing above-grade and the prohibitions on buried suction lines. Drive-point wells may also be installed by any contractor licensed or registered to construct wells including well contractors, dewatering contractors, monitoring contractors, or drive-point well or dug well contractors. The rules must be followed, including notification and permit requirements.

***Subp. 26c. Drive-point well or dug well contractor. “Drive-point well or dug well contractor” means a person issued a limited well/boring contractor’s license to construct, repair, or seal drive-point wells or dug wells.***

***Subp. 26d. Driven casing. “Driven casing” means steel casing forced into the ground as the well or boring is advanced, where the outside diameter of the drill bit or drilling tools is equal to or less than the outside diameter of the casing, casing coupling, or drive shoe.***

Driven casing includes wells or borings installed by cable tool, drill and drive, casing hammer, coring, or other technique where the casing is pounded or driven in the ground as drilling progresses. It does not include casing advanced by underreaming a hole larger than the casing outside diameter, or drilling a larger (rotary) hole and “pushing” the casing through the drilling mud.

***Subp. 27. Dug well. “Dug well” means a well that is excavated or dug with unconventional drilling equipment in which the side walls may be supported by material other than standard weight steel casing, stainless steel casing, or plastic casing as specified in this chapter. Water enters a dug well through the side walls and bottom.***

Dug wells are a type of water-supply well. The construction must follow the general requirements for wells and borings (Minnesota Rules, part 4725.2010 through part 4725.3875), and the water-supply well requirements (Minnesota Rules, part 4725.4050 through part 4725.6050). The special dug well

requirements are located in Minnesota Rules, part 4725.5750. The special dug well standards of Minnesota Rules, part 4725.5750 apply only to large-diameter water-supply wells, which are dug, bored, or augered.

Dug wells were historically cased with wood, brick, stone, concrete, or metal pipe. Many dug wells cased with these materials still exist. Previous rules allowed the use of concrete “curbing” with certain restrictions and precautions. Because of the much higher incidences of contamination in wells cased with these materials, the 2008 rules required the use of standard steel or plastic casing in new wells. The rules do address repair and sealing of older dug wells cased with alternative materials such as the alternate sealing materials and methods for dug wells located in Minnesota Rules, part 4725.3850, subpart 4.

For the purposes of the rules, “dug well” and “bored well” are synonymous.

***Subp. 27a. Elevator boring.*** “Elevator boring” has the meaning given in Minnesota Statutes, section 103I.005, subdivision 6, and does not include cable elevators, hydraulic cylinders used to elevate automobiles, or holeless elevators where the depth of the excavation is less than ten feet below the lowest landing of the elevator.

The term “**elevator boring**” is defined in Minnesota Statutes, Chapter 103I, as “a bore hole, jack hole, drilled hole, or excavation constructed to install an elevator hydraulic cylinder.” The definition does not include cable elevators without a hydraulic cylinder, the “boring” the elevator car rides in, or hydraulic cylinders or lifts for other purposes such as automobile lifts at service stations. A “holeless” or “limited access” hydraulic elevator is not included if the depth of the excavation including the pit and jackhole are less than 10 feet below the lowest landing of the elevator.

Elevators are of two general types. One uses a hydraulic piston extending into the ground approximately as deep as the elevator is tall. The cylinder or “jack” pushes the elevator car up, and is lowered by gravity. Practically, most hydraulic elevators are limited to seven stories. These are regulated by the rules. The other type of elevator is driven by an electric motor pulling up a cable attached to the elevator car and running over pulleys mounted on top of the elevator chase. This type of elevator is not regulated by the MDH. Certain aspects of safety and construction of both types of elevators are regulated by the Minnesota Department of Labor and Industry (DLI).

***Subp. 27b. Elevator boring contractor.*** “Elevator boring contractor” has the meaning given in Minnesota Statutes, section 103I.005, subdivision 7.

“**Elevator boring contractor**” means a person with an elevator boring contractor’s license issued by the commissioner of health.

***Subp. 27c. Environmental bore hole.*** “Environmental bore hole” has the meaning given in Minnesota Statutes, section 103I.005, subdivision 8. An environmental bore hole must enter or go through a water bearing layer, be deeper than 25 feet or penetrate a confining layer, and be used for testing or for remediation of soil or groundwater contamination without extracting water. An environmental bore hole includes excavations used to:

A. measure groundwater levels, including an excavation used as a piezometer;



- B. determine groundwater flow direction or velocity;*
- C. measure earth properties such as hydraulic conductivity, bearing capacity, or resistance;*
- D. obtain samples of geologic materials for testing or classification; or*
- E. remove or remediate pollution or contamination from groundwater or soil through the use of a vent, vapor recovery system, or sparge point without extracting groundwater.*

Minnesota Statutes, Chapter 103I, defines “**environmental bore hole**” as a hole or excavation in the ground that penetrates a confining layer or is greater than 25 feet in depth and enters or goes through a water-bearing layer and is used to monitor or measure physical, chemical, radiological, or biological parameters without extracting water. An environmental bore hole also includes bore holes constructed for vapor recovery or venting systems. An environmental bore hole does not include a well, elevator boring, exploratory boring, or monitoring well.

### **WHAT IS AN ENVIRONMENTAL BORE HOLE?**

An excavation or drill hole is an environmental bore hole if the drill hole meets **all** three conditions:

1. **THE DRILL HOLE MUST INTERCEPT A WATER-BEARING LAYER.** For the purposes of the rules, a water bearing layer is interpreted to mean an aquifer. An aquifer is a saturated geologic material that can transmit sufficient quantity of water to supply a well. An aquifer will have a hydraulic conductivity of  $10^{-6}$  cm/sec or greater. Typically, an aquifer will have a sustained yield of .25 gallons per minute or greater. For the purposes of the rule, an artificially created basin, not hydraulically connected (less than  $10^{-6}$  cm/sec hydraulic conductivity) to the earth outside the artificial basin, is not considered a water-bearing layer. Such basins may include a landfill liner or an excavated basin in clay for petroleum tanks.
2. **THE DRILL HOLE MUST BE EITHER DEEPER THAN 25 FEET OR PENETRATE A CONFINING LAYER.** The depth is measured to the deepest penetration of the drill hole, not to the top of the casing, or even bottom of the screen if the drill hole extends below the screen. A confining layer in unconsolidated materials or rock other than the Paleozoic confining layers as specified in Minnesota Rules, part 4725.2020, must be a minimum of 10 feet thick. If 10 feet of a confining layer is penetrated, the drill hole is an environmental bore hole. Peat and muck swamp deposits are not considered confining layers.
3. **THE DRILL HOLE MUST BE USED FOR TESTING WITHOUT EXTRACTING WATER OR BE USED FOR VENTING, VAPOR RECOVERY, OR SPARGING TO REMOVE SOIL OR GROUNDWATER CONTAMINATION.** Testing includes measuring a water level, testing earth properties, or obtaining geologic samples for identification or other testing.

Examples of environmental bore holes include piezometers, soil borings, geologic test holes, inclinometers, pressure transducers, and vents or air sparging points that meet the requirements of the definition and paragraph above.

If a **water sample** is obtained from an excavation, regardless of depth, and tested, the excavation is a monitoring well, not an environmental bore hole.

Metallic mineral, kaolin clay, petroleum, natural gas, apatite, diamond, graphite, or gemstone exploration holes are regulated as exploratory borings, not environmental bore holes. Exploration for gravel or aggregate deposits for economic recovery, are not included in the definition of environmental bore hole.

#### ENVIRONMENTAL BORE HOLE REGULATION

- A permit, notification, or fee is not required to construct or seal an environmental bore hole.
- An environmental bore hole may be constructed by a well contractor or monitoring well contractor, and sealed by a well contractor, limited sealing contractor, or monitoring contractor.
- A construction report is required unless the environmental bore hole is sealed within 30 days of construction.
- A sealing report is required.

25 Feet Deep or Less

Greater Than 25 Feet Deep

EBH

NOT AN EBH

EBH

NOT AN EBH

- Penetrates a confining layer
- Screen in water

- No confining layer
- Screen in water

- Screen in water

- Screen above water

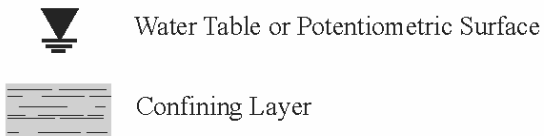
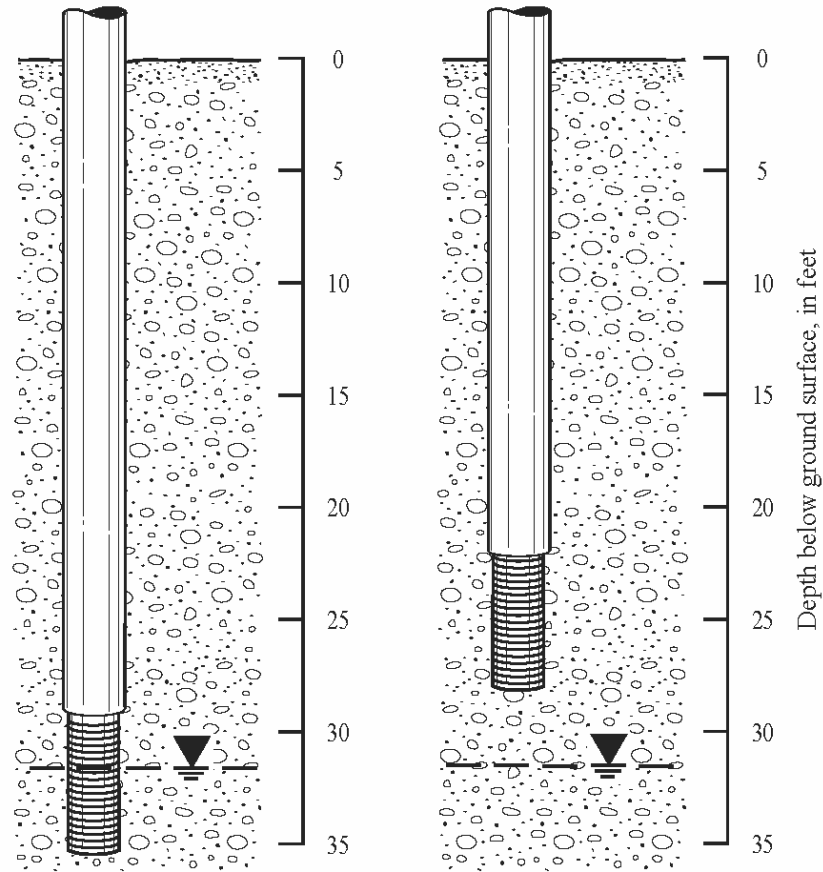
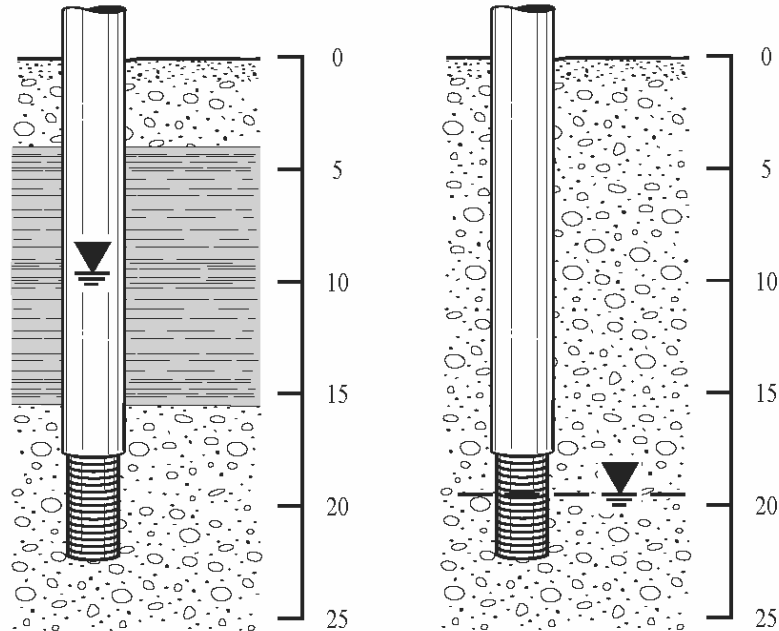

R. C. Nielsen  
- 2010 -

Figure 3. Environmental Bore Holes (EBH)

*Subp. 28. **Established ground surface.** “Established ground surface” means the intended or actual finished grade (elevation) of the surface of the ground at the site of a well or boring.*

The established ground surface is measured at the time a well or boring is completed and for the life of the well or boring.

The established ground surface on a paved surface refers to the surface of the pavement, not the sub-base.

*Subp. 28a. **“Feedlot”.** “Feedlot” has the meaning given in part 7020.0300, subpart 3.*

“**Animal feedlot**” is defined in MPCA Rules, part 7020.0300, subpart 3, to mean a lot or building or combination of lots and buildings intended for the confined feeding, breeding, raising, or holding of animals and specifically designed as a confinement area in which vegetative cover cannot be maintained within the enclosure. For purpose of these parts, open lots used for the feeding and rearing of poultry (poultry ranges) shall be considered to be animal feedlots. Pastures shall not be considered animal feedlots under these parts.

*Subp. 29. [Repealed, 17 SR 2773]*

*Subp. 29a. **Groundwater.** “Groundwater” has the meaning given in Minnesota Statutes, section 115.01, subdivision 6, and does not include water in an artificially created basin, such as a tank excavation, that is not hydrologically connected to the earth outside the basin.*

“**Groundwater**” is defined as “water contained below the surface of the earth in the saturated zone including, without limitation, all waters whether under confined, unconfined, or perched conditions, in near-surface unconsolidated sediment or regolith, or in rock formations deeper underground.”

For the purposes of the rule, water in an **artificially created basin**, not hydraulically connected (less than  $10^{-6}$  cm/sec hydraulic conductivity) to the earth outside the artificial basin, is not considered groundwater. Such basins may include a landfill liner or an excavated basin in clay for petroleum tanks.

The appendix contains a generalized state geologic map, a hydrogeologic column for southeastern Minnesota, and a discussion about groundwater in Minnesota.

*Subp. 29b. **Groundwater thermal exchange device.** “Groundwater thermal exchange device” has the meaning given in Minnesota Statutes, section 103I.005 subdivision 11, and includes a water-supply well used to withdraw or inject groundwater for a heat pump.*

“**Groundwater thermal exchange device**” is defined in Minnesota Statutes, Chapter 103I, as “a heating or cooling device that depends on extraction and reinjection of groundwater from an independent aquifer to operate.” A groundwater thermal exchange device is a system which withdraws groundwater from a well, extracts heat (in the heating mode) or adds heat (in the cooling mode) to the groundwater by use of a heat pump, uses the heat pump to heat or cool a building or other facility, and then injects the groundwater into the same aquifer from which it was withdrawn, a system sometimes referred to as a “standing column.” Injection may also be into another well. Two well groundwater thermal exchange

devices may switch withdrawal and injection in heating and cooling modes to gain some thermal efficiency. Groundwater thermal exchange device withdrawal and injections wells are water-supply wells. A groundwater thermal exchange device permit is required when injecting groundwater into a well. The permit requirements are found in Minnesota Rules, part 4725.1831.

A groundwater thermal exchange device permit is not needed to operate a “pump and dump” heat pump that disposes of the groundwater to the surface or shallow subsurface, not into a well. The normal notification is required if a well is constructed, and backflow prevention requirements apply. Disposal of water from this system may be regulated by the MPCA under a discharge permit, the DNR if the discharge is to a public water, and a local government including a Soil and Water Conservation District.

An appropriation permit is required from the DNR if water is removed in excess of 10,000 gallons per day or 1 million gallons per year.

***Subp. 30. Grout. “Grout” means a low permeability material used to fill the annular space around a casing, or to seal a well or boring. Grout is either neat-cement grout, cement-sand grout, or bentonite grout.***

The definitions and formulas for the different types of grout are located in this rule part. The general requirements for grouting are found in Minnesota Rules, part 4725.3050. Additional grouting requirements are found in the rule parts pertaining to interconnection of aquifers, flowing wells and borings, sealing, dug wells, dewatering wells, monitoring wells, vertical heat exchangers, elevators, and environmental bore holes.

***Subp. 30a. [Repealed, 33 SR 211]***

***Subp. 30b. [Repealed, 17 SR 2773]***

***Subp. 30c. Hazardous substance. “Hazardous substance” has the meaning given in Minnesota Statutes, section 115B.02, subdivision 8.***

“**Hazardous substance**” is defined in Minnesota Statutes, section 115B.02, subdivision 8, to mean:

- Any commercial chemical designated pursuant to the Federal Water Pollution Control Act, under United States Code, title 33, section 1321(b)(2)(A);
- Any hazardous air pollutant listed pursuant to the Clean Air Act, under United States Code, title 42, section 7412; and
- Any hazardous waste.

“**Hazardous waste**” is defined in Minnesota Statutes, section 115B.02, subdivision 9, to mean:

- Any hazardous waste as defined in Minnesota Statutes, section 116.06, subdivision 11, and any substance identified as a hazardous waste pursuant to rules adopted by the agency under Minnesota Statutes, section 116.07; and
- Any hazardous waste as defined in the Resource Conservation and Recovery Act, under United States Code, title 42, section 6903, which is listed or has the characteristics identified under United States Code, title 42, section 6921, not including any hazardous waste the regulation of which has been suspended by act of Congress.

“Hazardous waste” is defined in Minnesota Statutes, section 116.06, subdivision 11, to mean: any refuse, sludge, or other waste material or combinations of refuse, sludge, or other waste materials in solid, semisolid, liquid, or contained gaseous form which because of its quantity, concentration, or chemical, physical, or infectious characteristics may (a) cause or significantly contribute to an increase in mortality or an increase in serious irreversible, incapacitating reversible illness; or (b) pose a substantial present or potential hazard to human health or the environment when improperly treated, stored, transported, or disposed of, or otherwise managed. Categories of hazardous waste materials include, but are not limited to: explosives, flammables, oxidizers, poisons, irritants, and corrosives. Hazardous waste does not include source, special nuclear, or by-product material as defined by the Atomic Energy Act of 1954, as amended.

“Hazardous waste” does not include natural gas, natural gas liquid, liquefied natural gas, synthetic gas usable for fuel, or mixtures of such synthetic gas and natural gas; nor does it include petroleum, including crude oil or any fraction thereof which is otherwise not a hazardous waste.

**Subp. 30d. Hoist.** “Hoist” means a motorized machine or mechanical device that is not a drilling machine, mounted on a truck, trailer, crawler, or skid, which is used to:

- A. remove or install a pump or pumping equipment, casing, screen, pitless adapter, or pitless unit;
- B. remove an obstruction from a well or boring;
- C. install a tremie pipe when sealing a well or boring; or
- D. conduct an activity which requires a license or registration issued under this chapter.

“Hoist” does not include hand-operated equipment such as a pipe wrench, chain, pulley, or tripod.

Hoists used to do work which is regulated by the rules must be registered annually with the MDH. An annual registration fee is required for each hoist. Hand-held equipment such as chains, come-alongs, wrenches, pulleys, and tripods are not required to be registered. Hoists used solely to load or unload cargo such as casing are not required to be registered.

**Subp. 30e. Holding tank.** “Holding tank” has the meaning given in part 7080.1100, subpart 40, and means a watertight tank for storage of sewage until it can be transported to a point of approved treatment and dispersal.

A holding tank is a sealed tank receiving untreated sewage that is regularly pumped to remove the sewage. Holding tanks are most commonly installed in areas of high groundwater, shallow bedrock, or clay soils, where a soil treatment and dispersal system (drainfield or mound) will not properly work.

**Subp. 30f. Hydrofracturing.** “Hydrofracturing” means the process of placing one or more packers into a bedrock formation, and injecting potable water under pressures high enough to open existing fractures or create new fractures in the bedrock for the purpose of increasing the water yield.

Hydrofracturing rules were first established in 2008, and are found in Minnesota Rules, part 4725.5475.

**Subp. 30g. Individual well contractor.** “Individual well contractor” means an individual licensed according to Minnesota Statutes, section 103I.525.

An individual well contractor must meet the same qualification requirements as the certified representative for the (full) well contractor. The qualification requirements are established in Minnesota Rules, part 4725.0650, subpart 1. The individual well contractor must obtain continuing education credits. The individual well contractor is not required to obtain a bond. An individual well contractor does not represent a firm, business, government agency, or himself as a sole proprietor. The individual well contractor may not contract for wells or borings, obtain permits, or sign records. The license is typically obtained by a person as a “back-up” in a firm that already has a certified representative, a person who wishes to represent a licensee at a later time, or by a person who is retiring or leaving the business but wishes to retain the license for future conversion to a certified representative for a “full” licensee. The individual license can be converted to a certified representative for a full licensee by completing a new application.

**Subp. 30h. Interceptor.** “Interceptor” has the meaning given in part 4715.0100, subpart 66.

Minnesota Rules, Chapter 4715, is the plumbing code of the DLI.

“Interceptor” means a device designed and installed so as to separate and retain deleterious, hazardous, or undesirable matter from normal wastes while permitting normal sewage or liquid wastes to discharge into the drainage system by gravity.

**Subp. 30i. Licensee.** “Licensee” means a person who is licensed as a well contractor, limited well/boring contractor, or elevator boring contractor under this chapter and Minnesota Statutes, chapter 103I.

“Person” is defined in Minnesota Statutes, Chapter 103I, as “an individual, firm, partnership, association, or corporation or other entity including the United States government, any interstate body, the state, and any agency, department, or political subdivision of the state.” When the term “person” is used in the rules, it may (and often does) refer to a company, not necessarily a human being.

In most cases the licensee is a business, not a human being. A **certified representative** (the human being who takes the exam and is responsible for the contracting operations), is not licensed but is certified, and represents a **licensee** (the business, partnership, sole proprietorship, or government agency).

**Subp. 30j. Limited well/boring contractor.** “Limited well/boring contractor” has the meaning given in Minnesota Statutes, section 103I.005, subdivision 12, and includes a person with a license to: construct, repair, or seal drive-point wells or dug wells; install or repair screens or pitless units or adapters and casing from the pitless unit or adapter to the upper termination of the casing; install a well pump or pumping equipment; seal wells or borings; construct, repair, or seal a dewatering well; or construct, repair, or construct, repair, or seal a vertical heat exchanger.

There are six limited licenses: drivepoint/dug well, screen/pitless, pump, sealing, dewatering, and vertical heat exchanger.

***Subp. 30k. Manure storage area. “Manure storage area” has the meaning given in part 7020.0300, subpart 14, and does not include a manure storage basin.***

“**Manure storage area**” is defined in MPCA Rules, Chapter 7020, to mean an area where animal manure or process wastewaters are stored or processed. Short-term and permanent stockpile sites and composting sites are manure storage areas. Animal manure packs or mounding within the animal holding area of an animal feedlot that are managed according to Minnesota Rules, part 7020.2000, subpart 3, are not manure storage areas.

“Manure storage area” does not include manure collector systems, drains, and gutters, which are included under the 50-foot separation to animal or poultry buildings; or lagoons or basins that are included in the 300, 150, or 100 foot separations.

“Animal manure” is defined in MPCA Rules, Chapter 7020, to mean poultry, livestock, or other animal excreta or a mixture of excreta with feed, bedding, or other materials.

***Subp. 30l. Manure storage basin. “Manure storage basin” means a lagoon, pit, impoundment, or excavation in the ground used to store liquid and solid manure.***

***Subp. 30m. Monitoring well. “Monitoring well” has the meaning given in Minnesota Statutes, section 103I.005, subdivision 14.***

“**Monitoring well**” is defined in Minnesota Statutes, Chapter 103I, as an excavation that is drilled, cored, bored, washed, driven, dug, jetted, or otherwise constructed to extract groundwater for physical, chemical, or biological testing. “Monitoring well” includes a groundwater quality sampling well.

Any excavation, regardless of the method of construction, depth, presence or absence of casing, or length of time the excavation is used, is a monitoring well if the excavation is constructed to remove one or more samples of groundwater for testing.

A monitoring well may be used to conduct a pumping test or aquifer test as a part of groundwater testing. Pumps must be installed and removed by a licensed or registered contractor.

A monitoring well may not be used to remove groundwater for remediation.

“**Motor fuel retail outlet**” means a continuous piece of property under single ownership, which sells or did sell petroleum at retail. Commonly these are gasoline stations, but also include marinas, flight services, or co-ops that sell petroleum at retail. The definition does not include petroleum tanks located at homes, businesses, commercial airlines, automobile rental agencies, or farms where the product is not sold at retail. The site does not include neighboring properties under different ownership, wholesale facilities, or facilities on which petroleum products are stored for personal or commercial use.



# IDENTIFYING ENVIRONMENTAL BORE HOLES, MONITORING WELLS, AND TEMPORARY MONITORING WELLS AND DETERMINING ADMINISTRATIVE REQUIREMENTS

**Is groundwater removed from the drill hole other than during the drilling and development process?**

Yes

Is the purpose of the drill hole to remove groundwater for monitoring or testing?

Yes

**Installation is a MONITORING WELL\***

Will well be sealed within 30 days of construction?

Yes

Will well be sealed within 72 hours of construction?

Yes

**Installation is a TEMPORARY MONITORING WELL\***

Construction Permit	No	Yes	Yes
Construction Record	No	No	Yes
Sealing Notification	Yes	Yes	Yes
Sealing Record	Yes	Yes	Yes

No

Is installation a Water-Supply Well (including Remedial Wells), Dewatering Well, or Groundwater Thermal Exchange Device?  
(See definitions in Minnesota Rules (MR), Chapter 4725, and Minnesota Statutes (MS), Chapter 1031.)

Yes

Construct and seal in accordance with MR 4725 and MS 1031.

No

Installation is not a MDH-regulated well or boring.

No

Does drill hole penetrate groundwater?

Yes

Is drill hole >25 feet deep or does it penetrate a confining layer?

Yes

Is drill hole used for testing earth properties, obtaining geologic samples, measuring water levels, determining groundwater flow direction or velocity, venting, vapor extraction, or sparging?

Yes

**Installation is an ENVIRONMENTAL BORE HOLE**

Will environmental bore hole be sealed within 30 days of construction?

Yes

Construction Permit	No	No
Construction Record	No	Yes
Sealing Notification	No	No
Sealing Record	Yes	Yes

No

No

No

Is installation an exploratory boring, vertical heat exchanger, or elevator boring?  
(See definitions in MR 4725, MR 4727, and MS 1031.)

Yes

Construct and seal in accordance with MR 4725 and MS 1031.

No

Installation is not a MDH-regulated well or boring.

\*Note: The local delegated well program should be contacted for requirements pertaining to monitoring wells if the local jurisdiction has been delegated the authority to regulate monitoring wells.

Cities: Bloomington and Minneapolis.  
Counties: Dakota, Olmsted, and Winona.

*Subp. 30n. Neat-cement grout. "Neat-cement grout" means a fluid mixture in the proportion of 94 pounds of Portland cement and not more than six gallons of water. Bentonite up to five percent by weight of cement (4.7 pounds of bentonite per 94 pounds of Portland cement) may be used to reduce shrinkage. Not more than 0.6 additional gallons of water may be added for each 1 percent of bentonite. Admixtures to reduce permeability or control setting time must meet ASTM Standard C494/C494M-04. The minimum density of neat-cement grout using regular (Type 1) Portland cement without bentonite or entrained air is 15.0 pounds per gallon. The minimum density of regular neat-cement grout with bentonite and without entrained air is:*

- A. 14.7 pounds per gallon for neat-cement grout and two percent bentonite;*
- B. 14.4 pounds per gallon for neat-cement grout and three percent bentonite;*
- C. 14.1 pounds per gallon for neat-cement grout and four percent bentonite; and*
- D. 13.8 pounds per gallon for neat-cement grout and five percent bentonite.*

#### **NEAT-CEMENT GROUT FORMULA**

- Not more than 6 gallons of water, and
- 94 pounds of Portland cement.
- Not more than 5 percent bentonite (4.7 pounds) may be added.

The American Petroleum Institute (API) recommends a water to cement ratio of 94 pounds of Portland cement to 5.2 gallons (0.7 cu. ft.) of water. This mixture provides for the least shrinkage and lowest permeability of standard neat cement.

Some manufacturers are supplying Portland cement in 42 kilogram (92.6 pound bags). The formula for neat-cement grout remains not more than 6 gallons of water to 94 pounds of Portland cement. The formula for the 42 kilogram bags is:

- Not more than 5 gallons and 117 fluid ounces of water (11 ounces less than a gallon) and
- 42 kilograms (92.6 pounds) of Portland cement.
- Not more than 5 percent cement bentonite (4.6 pounds) may be added.

#### **NEAT CEMENT AND BENTONITE**

Bentonite may be added to a maximum of 5 percent by weight. The addition of bentonite improves workability, reduces weight, reduces shrinkage, and lowers cost. If the bentonite percentage is too high, the grout will have lower compressive strength, lower resistance to chemical degradation, and higher permeability. If bentonite is added to neat cement, additional water may be added according to the following table:

## NEAT-CEMENT AND BENTONITE WATER RATIOS AND DENSITIES

Mixture	Water Ratio (Gal/94 lb. bag of cement)	Minimum Density (lbs./gal.)
Neat-cement	6.0	15.0
Neat-cement & 1% Bentonite	6.6	15.0
Neat-cement & 2% Bentonite	7.2	14.7
Neat-cement & 3% Bentonite	7.8	14.4
Neat-cement & 4% Bentonite	8.4	14.1
Neat-cement & 5% Bentonite	9.0	13.8

Chemical admixtures to reduce permeability or control setting time must meet **American Society for Testing and Materials (ASTM) Standard C494/C494M-04**. “Superplasticizers” for geothermal or other applications to improve flowability or reduce water requirements may be used if they meet ASTM C494 and ANSI/NSF Standard 60. Normally, Type I or IA Portland cement without admixtures or bentonite is used for routine grouting.

The approximate volume of (dry) Portland cement in a 94-pound sack is 1.0 cubic foot.

One cubic yard of neat-cement grout should contain 21.2 (94-pound) sacks of cement at the ratio of one sack (94 lbs.) of cement to 6 gallons of water.

A “mud” balance may be used to determine the density of neat cement and therefore the ratio of Portland cement to water. The mud balance measures density, commonly in units of pounds per gallon (lbs./gal.).

### NEAT-CEMENT GROUT DENSITY AND YIELD

Portland (pounds)	Water (gallons)	Grout Density (pounds per gallon)	Grout Yield (gallons, cubic feet)
94	5.2	15.5	8.8 gal. 1.18 ft <sup>3</sup>
94	6.0	15.0	9.5 gal. 1.28 ft <sup>3</sup>

### ENTRAINED AIR

Air-entrained cement is cement containing a large number of microscopic air cells, typically comprising 5 to 8 percent of the cement volume. Air entrained cement has less shrinkage, less cracking, better resistance to freeze-thaw, better workability, and lower permeability. Air entrainment can be accomplished by using an air-entraining Portland cement (ASTM Type IA, IIA, or IIIA) or by the addition of air-entraining admixtures. Highly alkaline or “hard” water will decrease the air content.

### CEMENT SHRINKAGE

Neat-cement grout shrinkage may be reduced by the use of air entrained cement as described above, reducing the water content to less than 6 gallons per 94 pounds, using a small amount of bentonite, or making sure that the grout is not diluted in the well or boring. Cement-sand grout also tends to shrink less.

***Subp. 30o. Noncommunity water system. “Noncommunity water system” means a public water system that serves an average of at least 25 persons daily at least 60 days a year, at a place other than their home, and that is not a community***

*public water system. Any water system meeting the criteria identified in this subpart that serves churches, schools, resorts, parks, camps, rest areas, or businesses is deemed to be a noncommunity water system.*

Additional information is found under “public water system.”

*Subp. 30p. **Ordinary high water level.** “Ordinary high water level” has the meaning given in Minnesota Statutes, section 103G.005, subdivision 14.*

“**Ordinary high-water level**” means the boundary of water basins, watercourses, public waters, and public waters wetlands. In addition:

- A. The ordinary high-water level is an elevation delineating the highest water level that has been maintained for a sufficient period of time to leave evidence upon the landscape, commonly the point where the natural vegetation changes from predominantly aquatic to predominantly terrestrial;
- B. For watercourses, the ordinary high-water level is the elevation of the top of the bank of the channel; and
- C. For reservoirs and flowages, the ordinary high water level is the operating elevation of the normal summer pool.

*Subp. 30q. **Pasture.** “Pasture” has the meaning given in part 7020.0300, subpart 18.*

Minnesota Rules, Chapter 7020, are feedlot rules of the MPCA.

“**Pastures**” are defined in Minnesota Rules, part 7020.0300, subpart 18, to mean areas where grass and other growing plants are used for grazing and where the concentrations of animals are such that a vegetation cover is maintained during the growing season except in the immediate vicinity of temporary supplemental feeding or watering devices.

*Subp. 30r. **Person.** “Person” has the meaning given in Minnesota Statutes, section 103I.005, subdivision 16.*

“**Person**” means an individual, firm, partnership, association, or corporation or other entity including the United States government, any interstate body, the state, and any agency, department, or political subdivision of the state. In many instances “person” does not mean a human being, but means a business.

*Subp. 30s. **Petroleum.** “Petroleum” has the meaning given in Minnesota Statutes, section 115C.02, subdivision 10.*

Minnesota Statutes, section 115C.02, subdivision 10, defines “petroleum” as:

- (1) Liquid petroleum products as defined in section 296A.01;
- (2) New and used lubricating oils; and
- (3) New and used hydraulic oils used in lifts to raise motor vehicles or farm equipment and for servicing or repairing motor vehicles or farm equipment.

Section 296A.01 defines petroleum products as: agricultural alcohol gasoline; aviation gasoline; aviation turbine fuel and jet fuel; biodiesel fuel; casinghead, absorption, condensation, drip, or natural gasoline; diesel fuel oil; dyed fuel; E85; ethanol, denatured; gas turbine fuel oil; gasoline; gasoline blended with nonethanol oxygenate; gasoline blended with ethanol; heating fuel oil; kerosene; marine gasoline; and M85.

*Subp. 31. [Repealed, 15 SR 78]*

*Subp. 31a. **Petroleum bulk storage site.** “Petroleum bulk storage site” means a property on which petroleum products are stored for sale and excludes pipeline terminals and refineries.*

A “**petroleum bulk storage site**” does not include home, farm, or business petroleum storage tanks where the storage is for consumption on the premises or on other premises or where the product is not stored for retail sale.

The petroleum bulk storage site only includes the continuous property on which the tanks are located, not other property, even if wells are being installed to monitor a spill from the petroleum site.

*Subp. 31b. [Repealed, 17 SR 2773]*

*Subp. 32. **Pitless adapter.** “Pitless adapter” means a watertight device allowing discharge through one or more openings of a casing.*

A pitless adapter is a mechanical device attached to the casing, typically below the frost level. The adapter allows water to be discharged through a watertight connection in the casing, while allowing internal parts of the adapter, drop pipe, and pump to be removed for service through the top of the casing. An adapter is connected to the casing by cutting or burning a hole in the side of the casing and attaching the adapter to the casing by welding, clamping, or less commonly, by a threaded connection. A pitless unit differs from an adapter, in that the casing for a pitless unit is removed from the frost line to the surface and replaced with a pitless unit and upper casing extension. Pitless units may be connected to the casing by a threaded, welded, or compression connection.

Pitless adapters and units must meet the standards of Minnesota Rules, parts 4725.3150 and 4725.4850. A list of currently approved pitless adapters and units is provided in the appendix. Adapters or units which are not included in the list may be used if the adapters or units meet the standards of the rules.

*Subp. 33. **Pitless unit.** “Pitless unit” means a watertight assembly with a cap that attaches to a casing below ground, allows subsurface discharge through one or more openings, and extends the upper termination of the casing above the established ground surface.*

A pitless unit is a complete assembly that replaces the casing, typically from the frost line to above ground. The unit allows water to be discharged while allowing internal parts of the unit, commonly a “spool,” drop pipe, and pump to be removed for service through the top of the casing extension. An adapter is connected to the casing by cutting off the casing and attaching the unit by threads, welding, or a compression fitting.

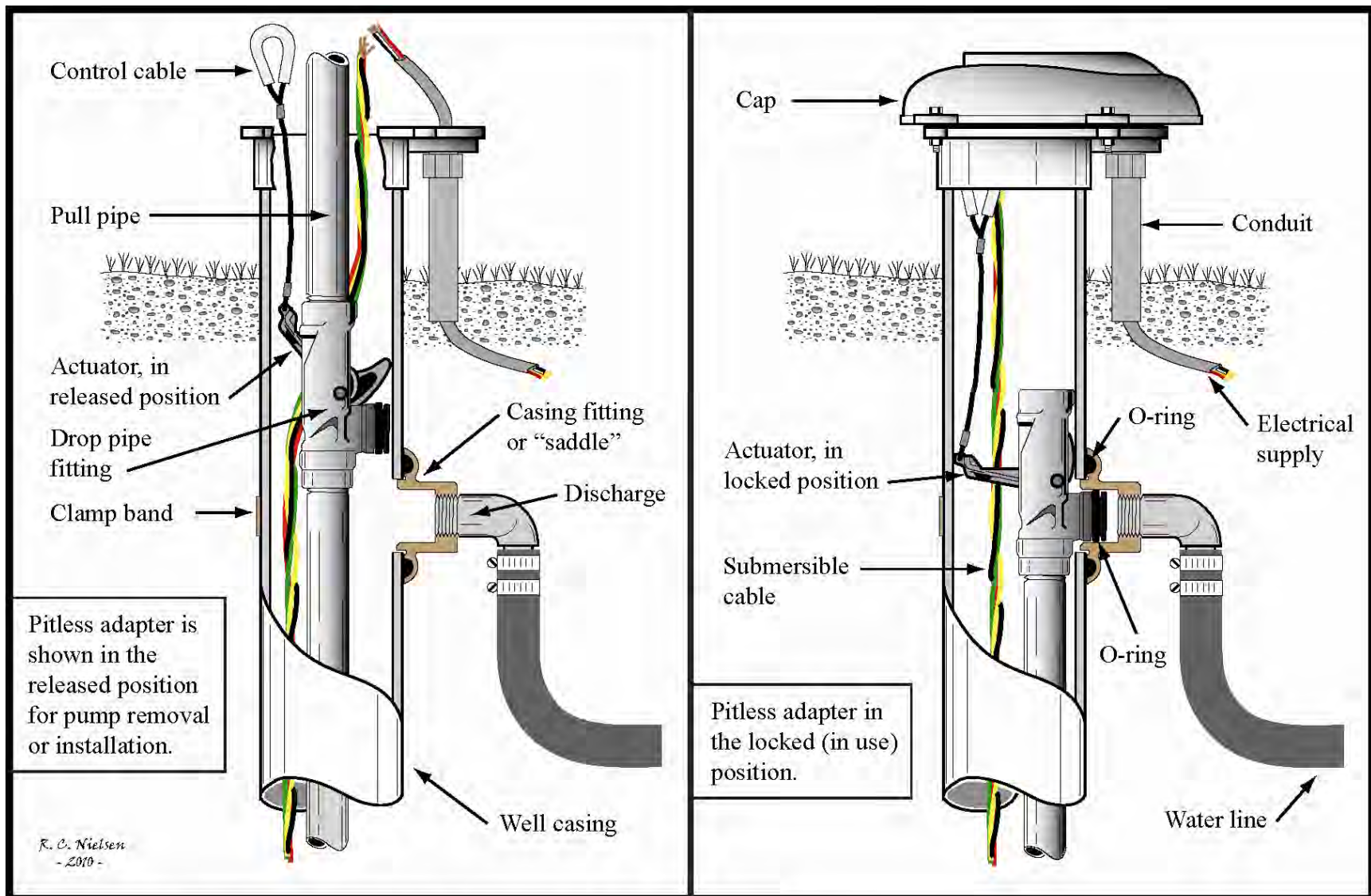

Figure 4. Typical Pitless Adapter Construction and Installation

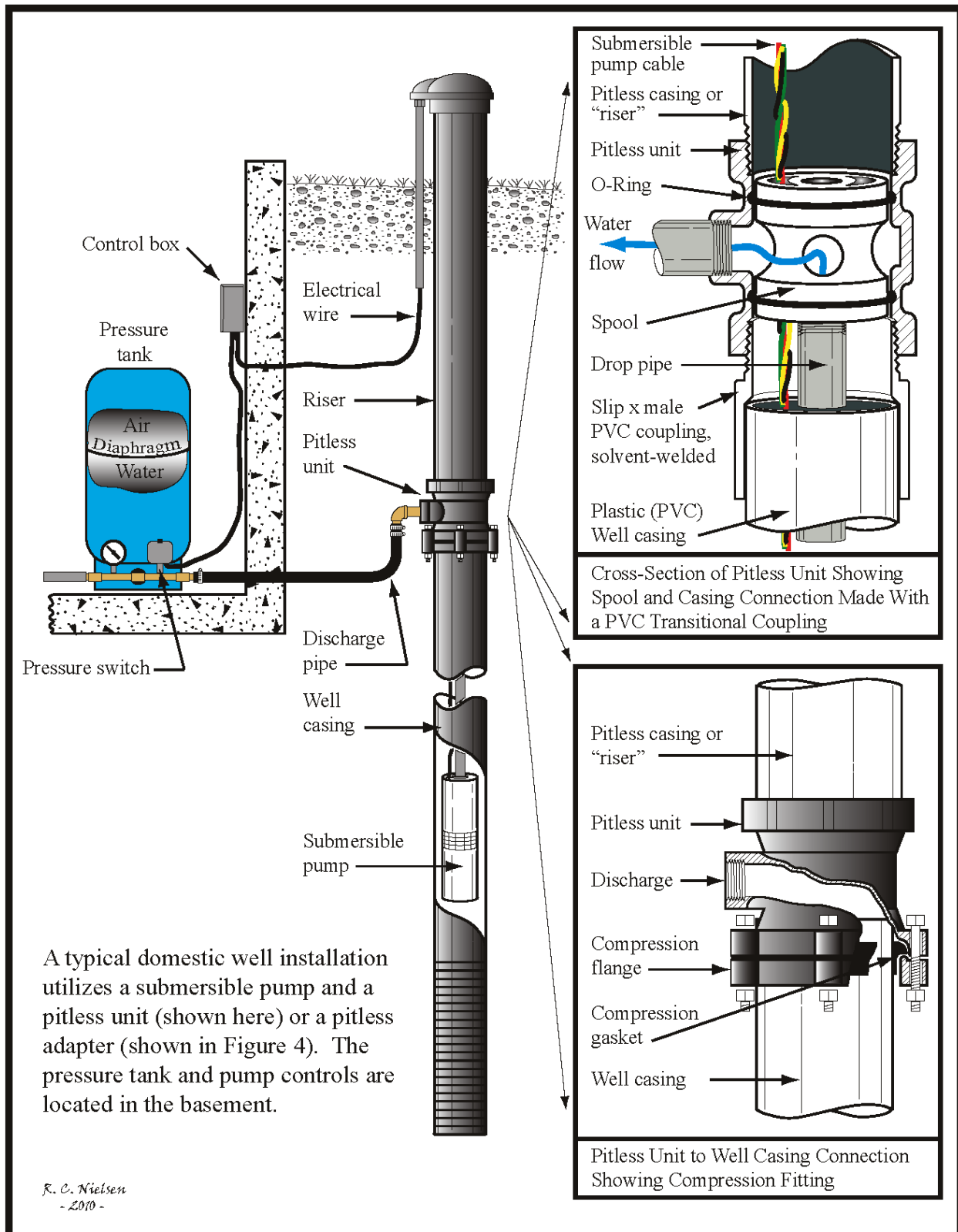

Figure 5. Typical Pitless Unit Construction and Installation

*Subp. 34. **Pollution or contamination.** “Pollution” or “contamination” means the presence or addition of any substance to groundwater which is or may become injurious to the health, safety, or welfare of the general public or private individuals using a well, boring, or groundwater; or which is or may become injurious to domestic, commercial, industrial, agricultural, or other uses which are being made of such water.*



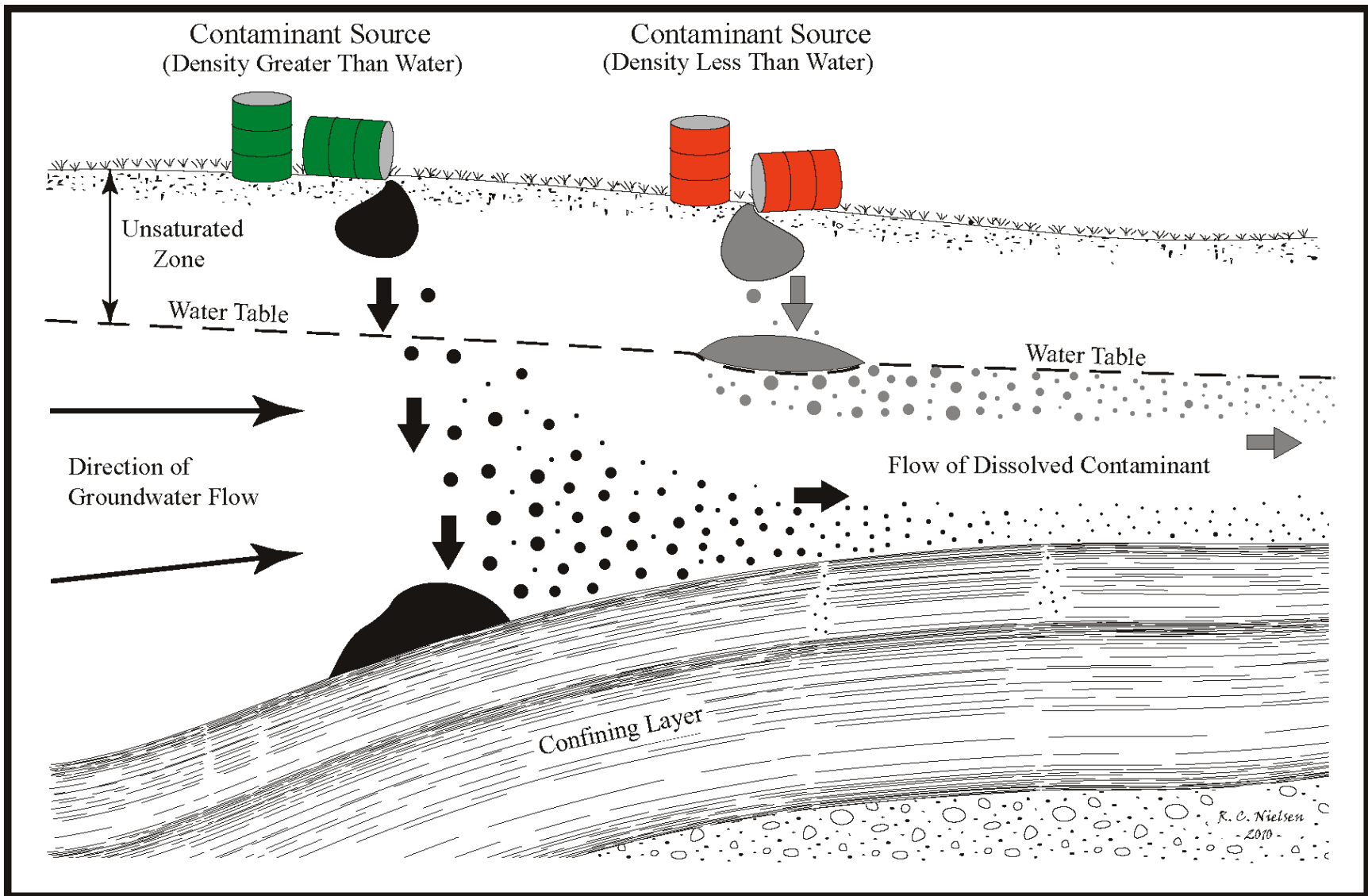

Figure 6. Effects of Contaminant Density on Migration

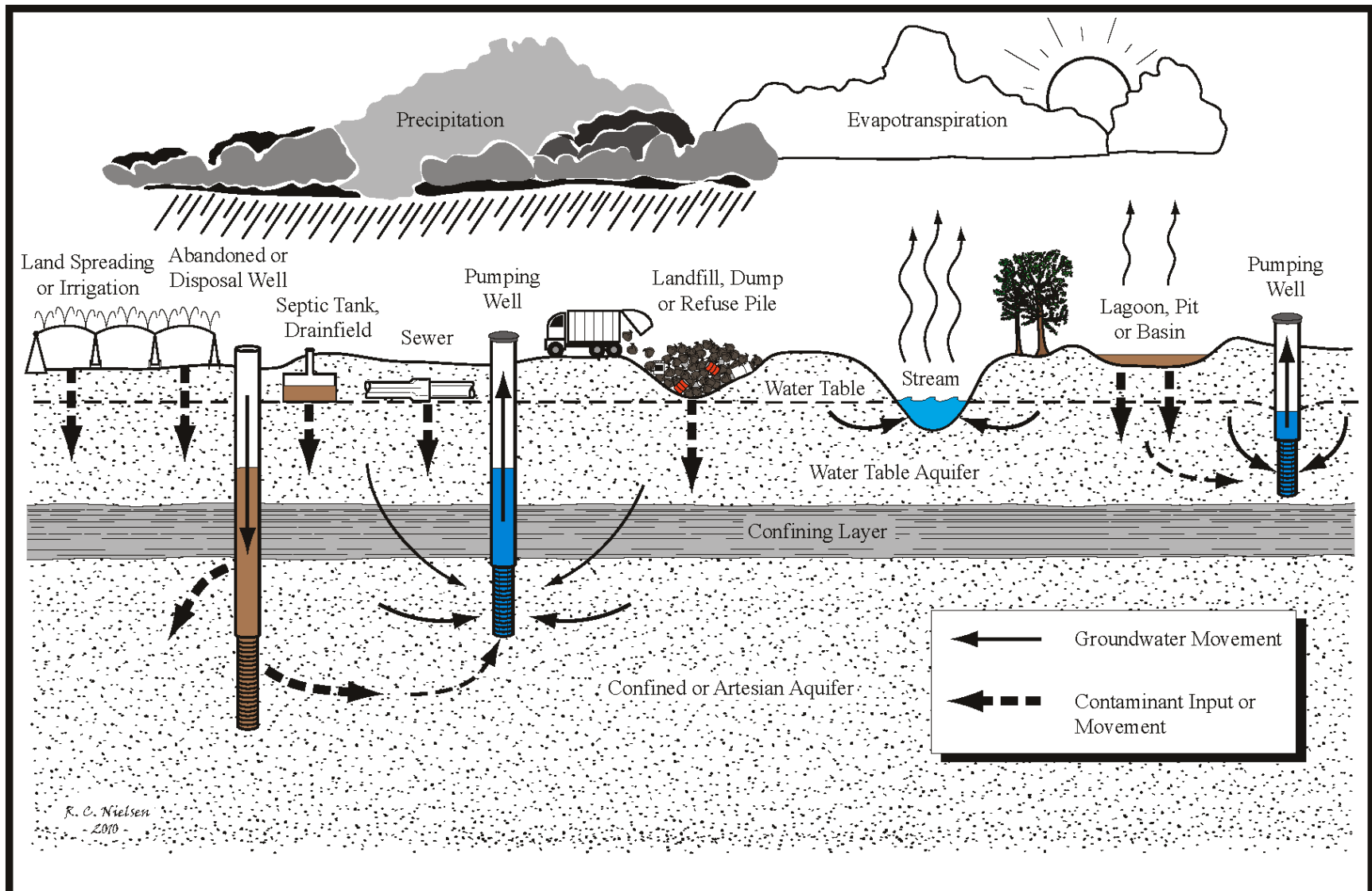

Figure 7. How Waste Disposal Practices May Contaminate Groundwater

(After E.P.A., 1984)

**Subp. 34a. Portland cement.** “Portland cement” means a construction material that conforms to ASTM Standard C150-04a, “Standard Specification for Portland Cement.”

“Portland cement” is a mixture of limestone and clay or shale. Iron or alumina may be added if necessary. The mixture is fired in a furnace, ground, and blended with a small amount of gypsum. Portland cements are manufactured to meet certain chemical and physical standards dependent on the application. The most common standards include American Society for Testing and Materials (ASTM), American Petroleum Institute (API), American Association of State Highway and Transportation Officials (AASHTO), and American Concrete Institute (ACI).

The ASTM standard referenced in the rule contains eight types of Portland cement:

- Type I – Regular Portland. This is the general-use cement for grouting.
- Type IA – Air-entraining. Air entraining means that bubbles are mixed in the cement which results in a finished cement which has lower weight, more resistance to freeze-thaw, and less shrinkage.
- Type II – Sulphate resistant. This cement generates less heat of hydration and more resistance to high sulphate groundwater.
- Type IIA – Air-entrained sulphate resistant.
- Type III – High early. Type III sets quicker and achieves high early strength, but generates greater heat of hydration.
- Type IIIA – Air-entrained high early.
- Type IV – Low heat of hydration.
- Type V – High sulphate resistance.

API Class A generally corresponds to ASTM Type I, API Class B corresponds to ASTM Type II, and API class C corresponds to ASTM Type III. ASTM Types IV and V have no corresponding API classes. Additional API classes include D through F which are retarded cements, and G and H which are basic cements.

**Subp. 35. Potable water.** “Potable water” means water which is safe for human consumption in that it is free from impurities in amounts sufficient to cause disease or harmful physiological effects.

**Subp. 35a. Potable water-supply well.** “Potable water-supply well” means a water-supply well used to provide water to humans for such purposes as drinking; cooking; bathing; manufacturing; or processing of food, drink, or pharmaceuticals; or to supply water to plumbing fixtures accessible to humans.

The Minnesota Plumbing Code, part 4715.0200, requires that all premises intended for human habitation, occupancy, or use must be provided with a potable water supply.

Water supplied to plumbing fixtures such as sinks must be potable water.

The Minnesota Plumbing Code, part 4715.1910, requires that if buildings have potable and nonpotable water systems, both systems must be **marked** either by color marking or metal tags. Potable water lines must be painted green and nonpotable water lines painted yellow. In lieu of painting the entire piping,

3-inch-wide bands may be painted at 25-foot intervals, at points where piping passes through walls, and at points of outlet for nonpotable water. Metal tags for potable water must be 3 inches in diameter bearing the legend “safe water.” Metal tags for nonpotable water lines must be 4-inch triangles bearing the legend “water unsafe.” Metal tags must be located at the same intervals and locations as the colored bands.

***Subp. 36. Pressure tank or hydropneumatic tank.*** “Pressure tank” or “hydropneumatic tank” means a closed water storage container constructed to operate under a designed pressure rating to modulate the water system pressure within a selected pressure range.

The rules contain standards for buried pressure tanks. A list of buried pressure tanks, which meet the standards of the rules, is included in the appendix. The DLI requires American Society of Mechanical Engineers (ASME) rated tanks for certain applications. See Minnesota Rules, part 4725.5350.

***Subp. 37. Priming.*** “Priming” means the first filling of a pump with water and the action of starting the flow in a pump.

***Subp. 37a. Public water-supply well.*** “Public water-supply well” means a well supplying water to a public water system.

***Subp. 37b. Public water system.*** “Public water system” means a community or noncommunity water system regulated under chapter 4720.

Minnesota Rules, Chapter 4720 contains the rules relating to public water supplies. A “**public water supply**” is defined in Minnesota Rules, part 4720.0100, subpart 16. “Public water supply” or “supply” means a system providing piped water for human consumption, and either containing a minimum of 15 service connections or 15 living units, or serving at least 25 persons daily for 60 days of the year. The term includes:

- Any collection, treatment, storage, and distribution facilities under control of the operator of the supply and used primarily in connection with the supply.
- Any collection or pretreatment storage facilities used primarily in connection with the supply but not under control of the operator. A public water supply is either a community or noncommunity water supply.

“**Community water supply**” means a public water supply or system which serves at least 15 service connections or living units used by year-round (defined as six months or longer) residents, or regularly serves at least 25 year-round residents. Examples of community systems include cities, mobile home parks, and extended health care facilities.

“**Noncommunity water supply**” means any public water supply that is not a community water supply. The following is given as examples of noncommunity water supplies and is in no way meant to be an exhaustive list: seasonal facilities such as children's camps, recreational camping areas, resorts or year-round facilities which serve at least 25 persons who are not residents thereof, such as churches, entertainment facilities, factories, gasoline service stations, marinas, migrant labor camps, office buildings, parks, restaurants, or schools.

“**Nontransient, noncommunity water supply**” means a public water supply that is not a community water supply and that regularly serves at least 25 of the same persons over six months per year. Factories, office buildings, day care centers, and schools are examples of nontransient, noncommunity water supplies.

**EXAMPLES OF PUBLIC AND NONPUBLIC (PRIVATE)  
WATER SUPPLIES**

EXAMPLE 1: FIVE HOMES WITH LESS THAN 25 PEOPLE CONNECTED TO A SINGLE WELL. This is **not** a public water supply since this does not serve more than 25 persons and there are less than 15 service connections or living units.

EXAMPLE 2: FIFTEEN HOMES OR AN APARTMENT BUILDING WITH 15 UNITS CONNECTED TO A SINGLE WELL. This is a (community) public water supply since it provides piped water to 15 or more service connections or living units.

EXAMPLE 3: A HOUSING DEVELOPMENT WITH A SINGLE HOMEOWNERS’ ASSOCIATION THAT HAS THREE WELLS, EACH WELL SERVING 6 HOMES (18 HOMES TOTAL). This is a (community) public supply, even if the systems are not interconnected, since a single management authority oversees the water system(s) that serve more than 15 residences.

EXAMPLE 4: A BUSINESS WITH A WELL AND 24 EMPLOYEES, WHICH SERVES **NO** MEMBERS OF THE PUBLIC. This is **not** a public water supply since it serves less than 25 people for 60 days of the year.

EXAMPLE 5: A BUSINESS WITH SIX EMPLOYEES, WHICH HAS A DRINKING FOUNTAIN ACCESSIBLE TO THE PUBLIC, AND WHICH HAS 20 OR MORE MEMBERS OF THE PUBLIC IN THE BUILDING AT LEAST 60 DAYS OF THE YEAR. This is a (noncommunity) public supply since it serves, or may serve (the water is accessible to), at least 25 people daily for 60 or more days per year.

*Subp. 38. [Repealed, 17 SR 2773]*

*Subp. 39. [Repealed, 17 SR 2773]*

*Subp. 40. **Pumping water level.** “Pumping water level” means the distance measured from the established ground surface to the water surface in a well being pumped at a specified rate for a specified period of time.*

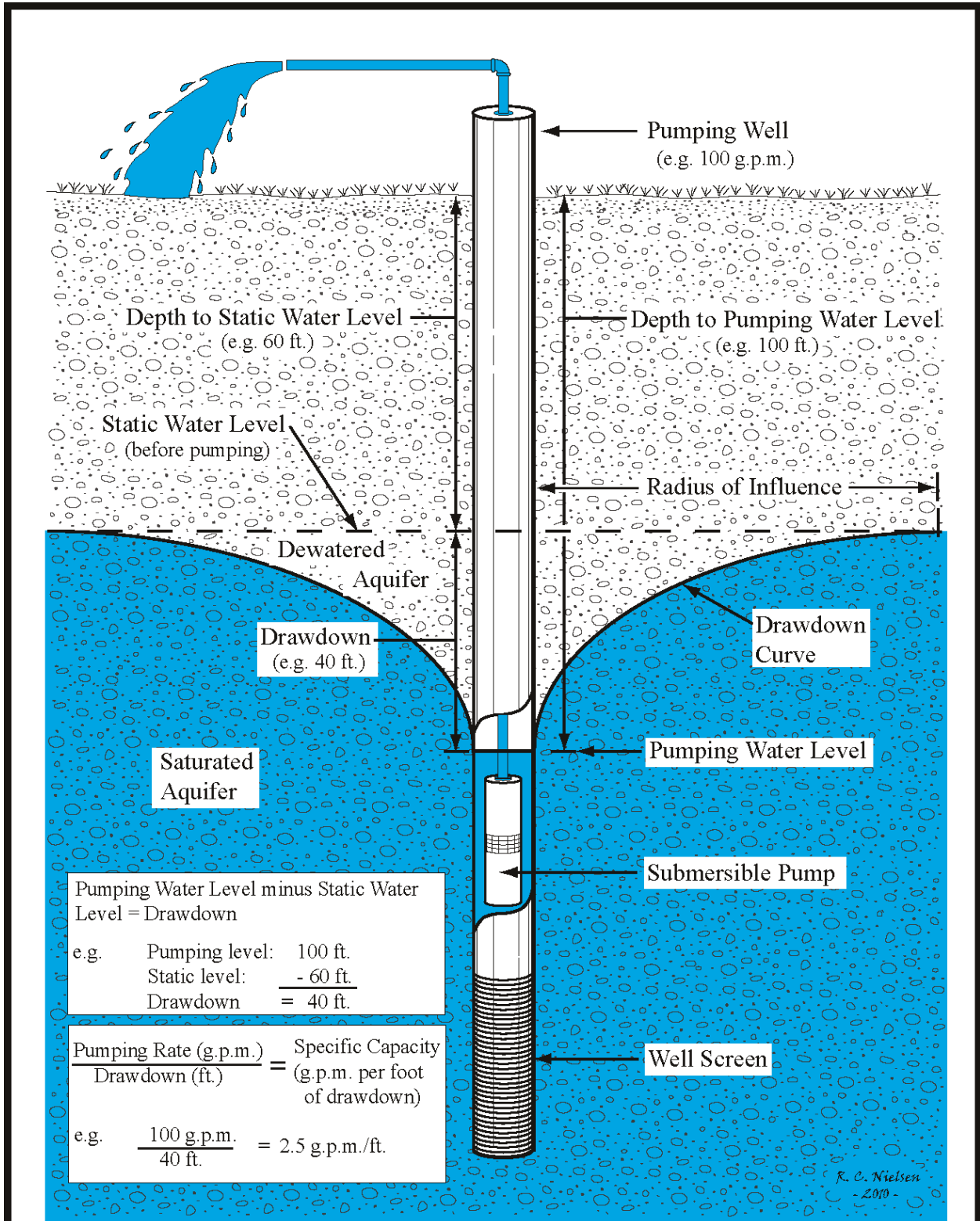

Figure 8. Terms Relating to Well Performance

**Subp. 40a. Rapid setting cement.** “Rapid setting cement” means a Type III Portland cement as designated in ASTM Standard C150-04a, an API Class C cement, or any Portland cement containing calcium chloride or sodium chloride in an amount between two and four percent by weight of Portland cement, or gypsum in an amount between 20 and 100 percent by weight of Portland cement.

“Rapid setting cement” may also be referred to as “hi-early cement, accelerated cement, Type C, or Type E cement.” Rapid setting cement is designed to develop a quick early set or hardening which allows for less wait time before resuming drilling. The rules require a 24-hour wait between the end of cementing and before drilling, development, pump, or other operations resume when regular cement (Type I) is used. The wait can be reduced to 12 hours if rapid setting cement is used.

In addition to the advantages of shortened wait-on-cement times, rapid setting cements have been used to seal lost circulation zones, grout flowing wells, and in cold weather. Disadvantages to rapid setting cements include higher costs, greater clean up difficulties, greater heat generated, and reduced working time. This latter disadvantage can have very serious consequences. In some cases, working times may be as short as 30 minutes. Contractors are cautioned that great care is needed to avoid plugging of grout pipes and pumps or cementing the grout pipe in the hole. Complete grouting of the annular space or casing must occur.

Commercially available rapid setting cements are designated as Type III, or API – C cements. Rapid setting cements are also referred to as “hi-early or accelerated cement.” Type III and API Class C cement are typically a finer grind of Portland cement or contain a higher tricalcium silicate or metacalcium silicate content. Rapid setting cements are often divided by the cement industry into “chloride” and “nonchloride” type. Chloride types contain predominately calcium chloride, but also may contain potassium chloride or sodium chloride. Nonchloride additives include calcium nitrate, sodium thiocyanate, triethanolamine, or N-nitrosodiethanolamine.

### **CEMENT ACCELERATORS**

Admixtures which accelerate or speed up cement set include:

**CALCIUM CHLORIDE** – Addition of up to 4 percent of calcium chloride by volume of cement provides accelerated setting time and higher early strength. Two percent of calcium chloride will approximately double the compressive strength in 24 hours. Concentrations over 4 percent will cause a reduction in early strength. Calcium chloride is the most common cement accelerator.

**SODIUM CHLORIDE** – Sodium chloride will provide accelerated setting time, but is not as effective as calcium chloride. Two to 3 percent is the typical range. High sodium chloride concentrations (greater than 14 percent) retard the set.

**GYPSUM** – Gypsum provides accelerated setting time, increases strength, and expands on setting. Additions of approximately 3 percent to 6 percent by volume of cement are typically used. Setting may start in as little as 30 minutes. Gypsum can result in a flash set which will easily plug grouting equipment.

*Subp. 40b. **Regional flood.** “Regional flood” has the meaning given in Minnesota Statutes, section 103F.111, subdivision 10.*

Minnesota statutes define “**regional flood**” as “a flood that is representative of large floods known to have occurred generally in the state and reasonably characteristic of what can be expected to occur on an average frequency in the magnitude of a 100-year recurrence interval.”

“Regional flood” refers to the **100-year flood**. Maps showing the 100-year flood and 100-year flood elevations are available from county and city planning and zoning departments, and the Federal Emergency Management Agency (FEMA). The DNR is the state coordinating agency for flood plain management.

*Subp. 41. [Repealed, 15 SR 78]*

*Subp. 41a. **Registrant.** “Registrant” means a person who is registered as a monitoring well contractor under this chapter and Minnesota Statutes, chapter 103I.*

“**Registrant**” refers to the person (usually a business) that is registered as a monitoring well contractor.

*Subp. 41b. **Remedial well.** “Remedial well” means a water-supply well used to lower a groundwater level to control or remove contamination in groundwater and excludes horizontal trenches, and sumps or pits less than ten feet deep.*

A “**remedial well**” is a type of water-supply well. A remedial well may only be constructed by a licensed well contractor, not by a monitoring well contractor or dewatering contractor. Notification must be filed prior to construction; a permit is not required. Construction must be in accordance with the general rules relating to wells and borings, the water-supply well requirements, and the remedial well requirements. Water withdrawals from remedial wells (or other wells) which exceed 10,000 gallons per day or 1 million gallons per year require an appropriation permit from the DNR.

Remedial wells include the traditional “pump and treat” wells, where water is pumped above ground, treated, and disposed of; and in-well “ART” type systems that pump and treat water within the well.

*Subp. 41c. [Repealed, 33SR 211]*

*Subp. 41d. **Rock.** “Rock” means a naturally formed aggregation of mineral matter including the rocks described in part 4725.1851, subpart 4, item B.*

“**Rock**” includes minerals of sedimentary, igneous, and metamorphic origin. Rock includes the types of bedrock in the Paleozoic sedimentary formations of southeastern Minnesota from the Cedar Valley limestone through the Fond du Lac formation, the Sioux quartzite of southwestern Minnesota, the iron formation and slates of east central and northeastern Minnesota; and the granites, basalts, and other igneous and metamorphic “basement” rocks throughout the state.

*Subp. 41e. **Sand.** “Sand” means unconsolidated mineral material composed principally of quartz ranging in size from 0.0025 to 0.040 inches in diameter.*



*Subp. 41f. **Scrap yard.** “Scrap yard” means an establishment, place of business, or place of storage or deposit, that is maintained, operated, or used for storing, keeping, buying, or selling scrap, junk, or waste metal obtained from automobiles, trucks, tractors, farm equipment, industrial equipment, containers, appliances or similar items, where the total scrap metal stored is greater than nine tons or consists of more than five motor vehicles.*

*Subp. 41g. **Screen.** “Screen” means a wire wrapped, gauze, shutter, slotted, or engineered perforated pipe at the bottom of a casing, designed to allow water to enter a well or boring and to prevent sediment from entering the well or boring.*

The specific rules pertaining to screens are in Minnesota Rules, part 4725.2750. Screens are also referenced in other rule parts including rules pertaining to gravel packs, Minnesota Rules, part 4725.2850 and interconnection of aquifers, Minnesota Rules, part 4725.2020.

*Subp. 41h. **Screen leader or riser.** “Screen leader or riser” means a pipe smaller in diameter than the casing that is attached to the top of a screen and telescoped into a casing.*

The rules contain specific restrictions on screen leaders or risers.

*Subp. 41i. **Screen sump.** “Screen sump” means a pipe attached to the bottom of a screen.*

*Subp. 41j. **Sealing.** “Sealing” means the process of preparing a well or boring to be filled with grout and the process of filling a well or boring with grout.*

The term “**sealing**” has replaced the term “**abandoned**” which has multiple, sometimes conflicting meanings. The term “abandoned” is no longer used in the rules. “Sealing” refers to the process of permanently taking a well or boring out of service by: removing pumping equipment; cleaning out debris or fill to the original depth; perforating, removing or grouting ungrouted casings; and completely filling the casing, screen or open hole, and annular space with grout.

*Subp. 42. [Repealed, 33 SR 211]*

*Subp. 43. **Seepage pit, leaching pit, or dry well.** “Seepage pit,” “leaching pit,” or “dry well” means an underground pit, tank, or receptacle into which a septic tank discharges effluent or other liquid waste and from which the liquid seeps into the surrounding soil through the bottom or openings in the side of the pit, tank, or receptacle.*

A seepage pit, leaching pit, or dry well is a tank, vessel, or lined excavation with holes or perforations that receives sewage from a septic tank. A “**dry well**” is a sewage disposal tank or pit. It is not a water well that has dried up.

*Subp. 43a. Sensitive water-supply well. “Sensitive water-supply well” means a water-supply well with less than 50 feet of watertight casing where the casing does not penetrate a confining layer or penetrate multiple layers of confining materials with an aggregate thickness of ten feet or more.*

Sensitive wells are more prone to effects from surface contamination because of shallow casing or lack of confining materials. Isolation distances between contamination sources entering the soil and sensitive wells must be doubled.

Sensitive water-supply wells are sometime erroneously referred to as “shallow” wells. Most sensitive wells are shallow, but some are not. A 400-foot deep rock well with 49 feet of casing penetrating only sand and gravel is a sensitive well since the well may be obtaining water at the 49-foot level and the overlying materials provide little protection from surface contaminants.

*Subp. 44. Septic tank. “Septic tank” means a watertight tank of durable materials through which sewage flows very slowly and in which solids separate from the liquid to be decomposed or broken down by bacterial action.*

A “**septic tank**” is a tank or receptacle, commonly made of concrete, steel, or plastic, which is sealed except for an inlet, outlet, and typically an access hole and vent pipe. The sewage enters the tank, is partially treated and flows into a drainfield or to other treatment. If the tank is perforated or otherwise designed to allow sewage to seep into the soil directly, the tank is a seepage pit, leaching pit, or dry well, and is not a septic tank.

*Subp. 44a. Sewage. “Sewage” has the meaning given in Minnesota Statutes, section 115.01, subdivision 17, and includes gray-water discharge from bathing and laundry.*

Minnesota Statutes, section 115.01, subdivision 17 defines “sewage” as the water-carried waste products from residences, public buildings, institutions, or other buildings, or any mobile source, including the excrementious or other discharge from the bodies of human beings or animals, together with such groundwater infiltration and surface water as may be present.

“**Gray-water**” is discharge from bathing and laundry, and is considered a type of “sewage.”

*Subp. 44b. Sewage sump. “Sewage sump” means a sump, dosing chamber, lift station, tank, pit, or receptacle which contains a pump to discharge sewage.*

Sumps have a separation or “isolation” distance from water-supply wells. The separation depends on the size and construction.

*Subp. 45. Sewer. “Sewer” means a pipe or conduit carrying sewage or into which sewage may back up, including floor drains and traps.*

A “**sewer**” is any pipe, piping material, hose, or conduit whether horizontal, vertical, or at any angle, which contains sewage or is connected to piping which contains sewage. **Floor drains**, stacks, or other parts of the drain, waste, and vent system are sewers. A sewer may be inside or outside the building.

A sewer does not include building footing drains (**drain tile**) for rain infiltration if the footing drains are not connected to piping which contains sewage, and if sewage cannot back up into the drain.

Additional information on sewers is contained in Minnesota Rules, part 4725.4450.

“Single motor fuel retail outlet” is a term used in Minnesota Statutes, Chapter 103I, to mean a continuous piece of property under single ownership which sells or did sell petroleum at retail. Commonly these are gasoline stations, but also include marinas, flight services, or co-ops that sell petroleum at retail. The definition does not include petroleum tanks located at homes, businesses, commercial airlines, automobile rental agencies, or farms where the product is not sold at retail. The site does not include neighboring properties under different ownership, wholesale facilities, or a facility on which petroleum products are stored for personal or commercial use.

**Subp. 45a. Soil dispersal system.** “Soil dispersal system” has the meaning given in part 7080.1100, subpart 79, and means the piping and media such as gravel, where sewage effluent is treated and dispersed into the soil by percolation and filtration, and includes trenches, seepage beds, drainfields, at-grade systems, and mound systems.

Soil dispersal systems are also sometimes called subsurface disposal systems, soil treatment systems, on-site systems, or soil disposal systems. Generically, people often call these “drainfields,” although the term “drainfield” refers to only one type of soil dispersal system. The soil dispersal system includes the piping which distributes the effluent, the media such as gravel (“drainfield” rock) that distributes the effluent, and the trench, bed, or mound designed to treat and dispose of the effluent. For the purposes of the isolation distances of Minnesota Rules, part 4725.4450, the distance between a water-supply well and the soil dispersal system is measured from the closest piping, distribution box, trench wall, or bed.

**Subp. 46. [Repealed, 33 SR 211]**

**Subp. 47. Static water level.** “Static water level” means the distance measured from the established ground surface to the water surface in a well or boring neither being pumped, nor under the influence of pumping nor flowing under artesian pressure.

A diagram depicting the static level is located after Minnesota Rules, part 4725.0100, subpart 40.

**Subp. 47a. Storm water drain pipe.** “Storm water drain pipe” means a pipe or conduit carrying storm water or surface water from a building roof, parking lot, street, or paved area. Storm water drain pipe does not include a pipe or conduit carrying;

- A. domestic waste water, sewage, or industrial wastes;
- B. clear water drainage from building perimeter drain tile; or
- C. water from a floor drain, not connected to a sewer, to a point of surface discharge.

Further discussion concerning the difference between a (regulated) storm water drain pipe, and an (unregulated) culvert is found in Minnesota Rules, part 4725.4350.

***Subp. 48. Subterranean gas. “Subterranean gas” means a gas occurring below the land surface. It may be flammable such as methane or highly toxic as hydrogen sulfide and may be associated with groundwater.***

Methane is a colorless odorless gas that is occasionally found in Minnesota groundwater and wells. Methane is primarily formed by the bacterial decomposition of organic materials. “Swamp gas” is largely comprised of methane formed by bacterial decomposition of vegetation. It is not known to be a health hazard when ingested with water. However, if methane concentrates in the air of a confined space, it can be flammable and explosive. Methane has an explosive limit between 5 percent and 14 percent. That means that if the methane concentration in air is between those numbers, it can ignite and explode. Methane concentrations in water of as little as 1 milligram per liter (mg/L) can lead to explosive levels if the gas is allowed to accumulate in a poorly ventilated confined space. Levels much higher than 1 mg/L have been measured in Minnesota wells. A spark from a control switch in a well house, or a flame from a water heater in a basement could ignite the methane and cause an explosion.

Methane is lighter than air, so it will rise to the ceiling if released inside a building or other enclosed space. Methane can displace oxygen, resulting in asphyxiation. Methane can also cause problems with the operation of the well pump and water system. Methane from the well, water storage tanks, water heaters, and any treatment devices should be vented to the atmosphere, outside of enclosed spaces such as well houses or homes. Methane will not be removed by common water treatment devices such as sediment filters, water softeners, or carbon filters. Most removal or treatment techniques involve aeration. A gas shroud, attached to the submersible pump in the well, may provide relief in some circumstances. Fittings that drain back or aerate water into the well have been used, but are not particularly effective and may cause other problems.

Hydrogen sulfide is a gas with a characteristic “rotten egg” smell. Most people can detect hydrogen sulfide by smell at concentrations of about 0.5 milligrams per liter (1/2 part per million). It typically is found in groundwater with low oxygen and acidic pH. Hydrogen sulfide can cause eye irritation at concentrations of 10 ppm in air, lung irritation at 20 ppm, and death at 600 ppm. Since it is heavier than air, it can collect in confined spaces and excavations such as well pits and basement offsets, and displace oxygen. These low oxygen atmospheres may not be detected since the human nose becomes desensitized to the smell of hydrogen sulfide, and if the spaces are entered, may cause unconsciousness and death. Hydrogen sulfide can occur from anaerobic decomposition of organic material, decomposition of some minerals, sulfur reducing bacteria, or from a catalytic reaction between sulfate in groundwater and the magnesium sacrificial rod in a water heater. A relatively constant smell in hot and cold water is typical of hydrogen sulfide in the aquifer. A variable smell in hot and cold water, and particularly if the smell worsens with lack of use and lessens with pumping, is typical of hydrogen sulfide produced by bacteria in the well or water system. A smell in the hot water only is typical of a water heater source. Treatment can involve use of a carbon filter, iron filter, “galvanized” pressure tank, aeration, chlorination, or anion exchange and filtration.

***Subp. 49. Suction line. “Suction line” means a pipe or line connected to the inlet side of a pump or pumping equipment or any connection to a casing that may conduct nonsystem water into the well or boring because of negative pressures.***

Suction lines are used with shallow well jet pumps, deep well jet pumps, and centrifugal pumps.

*Subp. 49a. [Repealed, 17 SR 2773]*

*Subp. 49b. **Total coliform bacteria.** “Total coliform bacteria” means all of the aerobic and facultative anaerobic, gram-negative, non-spore-forming, rod-shaped bacteria that ferment lactose with gas formation within 48 hours at 35 degrees centigrade.*

Total coliform bacteria are a group of approximately two dozen different organisms used to indicate the sanitary quality of water. Most total coliform species do not cause disease, but several can. Testing for all possible disease causing organisms such as typhoid, giardia, or salmonella, would be prohibitively difficult and expensive. Because coliform bacteria are commonly found in the intestinal tract of warm-blooded animals, including humans, and on or near the ground surface, but usually not very deep in the ground, the presence of coliform bacteria in well water indicates that there is inadequate protection of the water supply and that contamination has entered into the well. This may be due to a variety of causes, including an opening in the casing, a leaking cap or seal, leakage through inadequate or absent grout, the introduction of bacteria into the well during drilling or well repair, or contamination of the aquifer. If coliform bacteria are getting into the water, there is also a chance that other disease organisms could also enter the water. Coliform bacteria are also good indicators of microbiological quality because they respond to disinfection the same way that most disease organisms do. When the coliform bacteria are killed, the disease organisms are typically killed also.

Coliform results are commonly reported as a fractional number of organism in 100 milliliters of water if the Most Probable Number (MPN) testing method is used, the number of organisms per 100 milliliters if the Membrane Filter (MF) testing method is used, and either positive or negative if a presence/absence method is used. The presence of any coliform organism is considered unacceptable. Acceptable results are reported as “< 2.2 organisms/100 ml” for the MPN method, “< 1 organism/100 ml” for the MF method, and “absent or negative” for the presence/absence method.

More information about coliform bacteria can be found in Minnesota Rules, part 4725.5550; Minnesota Rules, part 4725.5650; and in the appendix.

*Subp. 49c. **Tremie pipe.** “Tremie pipe” means a pipe or hose used to insert grout into an annular space, well, or boring.*

“**Tremie pipe**” is synonymous with the term “grout pipe.” The rules do not contain standards for the diameter or materials of the tremie pipe. A drill rod may be used as a tremie pipe. In many applications, grouting is more successful through larger diameter tremie pipes.

*Subp. 49d. **Unconsolidated materials.** “Unconsolidated materials” means geological materials that are not bedrock and includes alluvium, glacial drift, glacial outwash, glacial till, lacustrine deposits, loess, saprolite, soil, and those materials specified in part 4725.1851, subpart 4, item A.*

Minnesota Rules, part 4725.1851, subpart 4, item A, is the Wentworth particle size chart which defines unconsolidated materials based on particle size from clay to cobbles.

Unconsolidated materials include glacial sediments, soils, fill, loess (wind blown silt), and lake and river deposits. These materials are generally not cemented or poorly cemented.

**Subp. 49e. Vertical heat exchanger.** “Vertical heat exchanger” has the meaning given in Minnesota Statutes, section 103I.005, subdivision 20.

“Vertical heat exchanger” is defined in Minnesota Statutes, Chapter 103I, as an earth-coupled heating or cooling device consisting of a sealed-piping system installed vertically in the ground to transfer heat to or from the surrounding earth. Vertical heat exchangers are commonly referred to as geothermal loops, heat loops, vertical loops, or closed loops.

**Subp. 49f. Vertical heat exchanger contractor.** “Vertical heat exchanger contractor” means a person issued a limited well/boring contractor’s license for constructing, repairing, and sealing vertical heat exchangers.

**Subp. 49g. Vertical heat exchanger piping.** “Vertical heat exchanger piping” means a sealed piping system, containing a heat transfer fluid, installed vertically in the ground, used to transfer heat to or from the surrounding earth.

The standards for vertical heat exchanger piping are contained in Minnesota Rules, part 4725.7050. The rule requires 160 psi pressure rated high density polyethylene meeting ASTM Standard D3035-03a. Joints must be socket or butt fused.

**Subp. 49h. Wastewater treatment unit.** “Wastewater treatment unit” has the meaning given in part 7045.0020, subpart 103.

“Wastewater treatment unit” means a device which:

- A. Is part of a wastewater treatment facility which is subject to regulation under the Federal Water Pollution Control Act Amendments of 1972, United States Code, title 33, sections 1317(b) and 1342, as amended;
- B. Receives and treats or stores an influent wastewater which is a hazardous waste as defined in Minnesota Rules, parts 7045.0102 to 7045.0143; or generates and accumulates a wastewater treatment sludge which is a hazardous waste as defined in Minnesota Rules, parts 7045.0102 to 7045.0143; or treats or stores a wastewater treatment sludge which is a hazardous waste as defined in Minnesota Rules, parts 7045.0102 to 7045.0143; and
- C. Meets the definition of “tank” as defined in subpart 90, or “tank system” as defined in subpart 90a.

**Subp. 50. [Repealed, 17 SR 2773]**

**Subp. 50a. Water-supply well.** “Water-supply well” has the meaning given in Minnesota Statutes, section 103I.005, subdivision 20a, and includes wells used:

- A. for potable water;
- B. for irrigation;
- C. for agricultural, commercial, or industrial water supply;
- D. for heating or cooling;
- E. as a remedial well; and

*F. for testing water yields for irrigation, commercial or industrial uses, residential supply, or a public water system.*

Most water-supply wells are used for residential or public water supply, but some are used for irrigation, commercial purposes, heat pumps, or remediation. Drive-point wells and dug wells used for the purposes listed above are water-supply wells.

The definition of “well” in Minnesota statutes is repeated in subpart 51 below.

Water-supply wells are one of the three types of “well”: monitoring, dewatering, and water-supply.

*Subp. 50b. Water table. “Water table” has the meaning given in part 7060.0300, subpart 8.*

Minnesota Rules, part 7060.0300, is a MPCA rule relating to underground waters. Subpart 8 defines “water table” as the surface of the groundwater at which the pressure is atmospheric. Generally this is the top of the saturated zone.

*Subp. 51. Well. “Well” has the meaning given in Minnesota Statutes, section 103I.005, subdivision 21, and includes water-supply wells, monitoring wells, and dewatering wells.*

Minnesota Statutes, section 103I.005, subdivision 21 defines “**well**” to mean an excavation that is drilled, cored, bored, washed, driven, dug, jetted, or otherwise constructed if the excavation is intended for the location, diversion, artificial recharge, or acquisition of groundwater. “Well” includes monitoring wells, drive-point wells, and dewatering wells.

“Well” does not include:

- An excavation by backhoe or otherwise for temporary dewatering of groundwater for nonpotable use during construction if the depth of the excavation is 25 feet or less (these excavations are not regulated by the MDH);
- An excavation made to obtain or prospect for oil, natural gas, minerals, or products of mining or quarrying (the majority of these excavations are regulated as exploratory borings under Minnesota Statutes, Chapter 103I and Minnesota Rules, Chapter 4727);
- An excavation to insert media to repressure oil or natural gas-bearing formations or to store petroleum, natural gas, or other products (these excavations are not regulated by the MDH but are regulated by the DNR);
- An excavation for nonpotable use for wildfire suppression activities (these excavations are not regulated by the MDH);
- Borings (exploratory borings, vertical heat exchangers, elevator borings, and environmental bore holes are regulated as borings, not as wells); or
- Springs that are naturally flowing are not regulated as wells. A spring box which only collects water which naturally flows at the surface from a spring is not a well. Excavations in the earth to tap a flowing aquifer are regulated as wells.

“Well that is in use” is not defined in the rules. It is defined in Minnesota Statutes, Chapter 103I, as a well that operates on a daily, regular, or seasonal basis. A well in use includes a well that operates for the purpose of irrigation, fire protection, or emergency pumping.

*Subp. 51a. Well pump or pumping equipment. “Well pump or pumping equipment” means a device, machine, or material used to withdraw or otherwise obtain water from a well, and all necessary seals, fittings, and pump controls. Well pump or pumping equipment does not include:*

- A. water tanks except for buried pressure tanks;*
- B. sampling devices placed in a monitoring well to obtain a water sample and are then removed after the sample is collected; or*
- C. devices used in the construction or rehabilitation of a well.*

The rules regulate the installation of materials from the bottom of the well up to the pressure tank. The rules contain standards for buried pressure tanks, but not for above-ground pressure tanks.

**Sampling devices** placed in a monitoring well to obtain a water sample, which are removed after the (single) sample is collected are not considered well pumps or pumping equipment.

A license or registration is needed to install or remove a well pump or pumping equipment. For further information see Minnesota Rules, part 4725.0475.

Hoists used to install or remove well pumps or pumping equipment must be registered.

*Subp. 52. [Repealed, 17 SR 2773]*

*Subp. 53. [Repealed, 17 SR 2773]*

*Subp. 54. [Repealed, 17 SR 2773]*

*STAT AUTH: MS s 103I.101; 103I.221; 103I.301; 103I.621; 144.05; 144.12; 144.383; 156A.01 to 156A.08; 157.04; 157.08; 157.09; 157.13*

*HIST: 8 SR 1625; 15 SR 78; 17 SR 2773; 25 SR 1207; 33 SR 211*

#### **4725.0150 INCORPORATIONS BY REFERENCE AND ABBREVIATIONS.**

*This part indicates documents, specifications, and standards that are incorporated by reference in this chapter. This material is not subject to frequent change, and is available from the source listed, for loan or inspection from the Barr Library of the Minnesota Department of Health, or through the Minitex interlibrary loan system. The abbreviations listed in parenthesis after the source name are used in this chapter.*

This rule part lists all of the national standards and documents referenced in the rule. The language in the standards is not included in the rule. The standards are available at the addresses listed. Copies are available for review at the MDH. Many of the references are available at university or technical libraries.



A. American Association of State Highway and Transportation Officials (AASHTO), 341 National Press Building, Washington, D.C. 20004.

(1) AASHTO Standard H20-44, "Standard Specifications for Highway Bridges," 17th Edition, 2002, part 3.7.2.

(2) AASHTO Standard M306-04, "Standard Specification for Drainage, Sewer, Utility, and Related Castings."

B. American Petroleum Institute (API), 1220 L Street, Northwest, Washington, DC 20005-4070.

(1) Specification 13A-04, "API Specification for Drilling Fluid Materials," 16th Edition.

(2) API Standard 5L-04, "Specification for Line Pipe."

C. American National Standards Institute (ANSI), 1430 Broadway, New York, New York 10018.

(1) ANSI Schedule 5 and Schedule 40, "Dimensions of Welded and Stainless Steel Pipe" as contained in ASA Standard B36.19 - 1965, "Welded and Seamless Wrought Steel Pipe."

(2) ANSI Standard Z34.1-1993, "Third Party Certification Programs for Products, Processes, and Services."

D. American Society of Mechanical Engineers, ASME International, Three Park Avenue, New York, NY 10016-5990, USA., ASME B36.10M-2000, "Welded and Seamless Wrought Steel Pipe".

E. American Society for Testing and Materials (ASTM), 100 Barr Harbor Drive, West Conshohocken, PA 19428-2959.

(1) ASTM A53/A53M-04a, "Standard Specification for Pipe, Steel, Black and Hot-Dipped, Zinc-Coated Welded and Seamless."

(2) ASTM A589-96 (2001), Types I, II, and III, "Standard Specification for Seamless and Welded Carbon Steel Water-Well Pipe."

(3) ASTM Standard A312/A312M-04b, "Standard Specification for Seamless, Welded, and Heavily Cold Worked Austenitic Stainless Steel Pipes."

(4) ASTM C150-04a, "Standard Specification for Portland Cement."

(5) ASTM C494/C494M-04, "Standard Specification for Chemical Admixtures for Concrete."

(6) ASTM D2466-02, "Standard Specification for Poly (Vinyl Chloride) (PVC) Plastic Pipe Fittings, Schedule 40."

(7) ASTM D2487-00, "Standard Classification of Soils for Engineering Purposes (Unified Soil Classification System)."

(8) ASTM D3035-03a, "Standard Specification for Polyethylene (PE) Plastic Pipe (DR-PR) Based on Controlled Outside Diameter."

(9) ASTM F480-02, "Standard Specification for Thermoplastic Water Well Casing Pipe and Couplings Made in Standard Dimension Ratios (SDR), SCH 40 and SCH 80."

F. American Water Works Association, 6666 West Quincy Avenue, Denver, Colorado 80235, ANSI/AWWA C219-01, "Bolted, Sleeve-Type Couplings for Plain-End Pipe."

G. NSF International, 789 Dixboro Road, P.O. Box 130140, Ann Arbor, Michigan 48113.

(1) ANSI/NSF 14-2003, "Plastics Piping System Components and Related Materials."

(2) ANSI/NSF 60-2003e, "Drinking Water Treatment Chemicals - Health Effects."

(3) ANSI/NSF 61-2003e, "Drinking Water System Components - Health Effects."

H. Sims, P.K. and Morey, G.B., "Geology of Minnesota: A Centennial Volume," pages 459-473, "Paleozoic Lithostratigraphy of Southeastern Minnesota" by George Austin, 1972.

I. United States Department of Agriculture, Agricultural Handbook Number 18, Soil Survey Manual pages 136 to 140, October, 1993.

STAT AUTH: MS s 103I.101; 103I.221; 103I.301; 103I.621; 144.05; 144.12; 144.383; 157.04; 157.08; 157.09; 157.13

HIST: 17 SR 2773, 33 SR 211

**End  
of  
General, Definitions Section**

## **4725.0200 APPLICATION TO ALL WELLS AND BORINGS.**

*Subpart 1. Applicability. This chapter applies to all wells and borings except exploratory borings regulated under chapter 4727 and those wells and borings specifically exempted by Minnesota Statutes, chapter 103I.*

### **TYPES OF WELLS**

“Wells” include monitoring wells, dewatering wells, and water-supply wells.

“Water-supply wells” include wells used: to supply potable water for private or public use; for irrigation; for agricultural, commercial, or industrial water supply; for heating or cooling; as a remedial well; or for groundwater thermal exchange device (groundwater heat pump) withdrawal or injection.

### **EXCAVATIONS WHICH ARE NOT WELLS**

Minnesota Statutes, Chapter 103I exempts the following from the definition of “well”:

- An excavation by backhoe, or otherwise for temporary dewatering of groundwater for nonpotable use during construction, if the depth of the excavation is 25 feet or less (these excavations are not regulated);
- An excavation made to obtain or prospect for oil, natural gas, minerals, or products of mining or quarrying (the majority of these excavations are regulated as exploratory borings);
- An excavation to insert media to repressure oil or natural gas-bearing formations or to store petroleum, natural gas, or other products (these excavations are not regulated by the MDH but are regulated by the DNR);
- An excavation for nonpotable use for wildfire suppression activities (these excavations are not regulated); or
- Borings (exploratory borings, vertical heat exchangers, elevator borings, and environmental bore holes are regulated as borings, not as wells).

**Excavations that are neither wells nor borings** include: cathodic protection holes; caissons or shafts for construction or access to underground structures; exploration drilling for gravel, aggregate or building stone; and drilling or driving pilings. Where possible, it is recommended that these excavations, and the excavations exempted under the definition of “well” be constructed by licensed or registered contractors and be constructed and sealed in accordance with these rules.

### **TYPES OF BORINGS**

“Borings” are holes or excavations that are not used to extract water, and include exploratory borings, environmental bore holes, vertical heat exchangers (vertical heat loops), and elevator borings.

## WELLS AND BORINGS ON NATIVE AMERICAN AND MILITARY RESERVATIONS

The MDH does not regulate wells or borings located within Native American reservations or military installations which are clearly under Native American or federal jurisdiction. The issue of jurisdiction, both on Native American land and federal property, can be very complicated.

The Minnesota Attorney General's office has advised the MDH that courts do not recognize state civil regulatory jurisdiction over Native American land within a reservation in Trust status. In such cases, the tribal government has jurisdiction over civil regulatory matters. They also note that in most cases involving individual Native American ownership outside the reservations, the state law applies. Nonnative Americans living on Native American land are subject to state law.

If you have any questions about the need for a notification or permit on other Native American or federal lands, we would be pleased to consult with the Attorney General's staff to clarify the issue.

- **Native American land within a reservation** – The licensing law, rules, notifications, and permits do **not** apply.
- **Native American owned land outside the reservation** – The state law and rules apply.
- **Non-Native Americans living within a reservation** – The state law and rules apply.
- **Federal military properties** – The licensing law, rules, notifications and permits do **not** apply.

## FEDERAL SUPERFUND (CERCLA) SITES

The state law and rules apply to wells and borings on federal superfund sites. However, under federal superfund law, work on the superfund site for contamination **remediation** must conform to the substantial requirements of state and local law but is exempt from permits and fees. That is, the well and boring rules must be followed, but permits and fees are not required. Permits are required for wells located off the superfund site and for wells at CERCLA sites for the investigation phase.

## WELLS AND BORINGS ON FEDERAL PROPERTY

Wells and borings on federal property, with the exceptions of Native American reservations, federal military reservations, and federal CERCLA sites, are governed under Minnesota Statutes, Chapter 103I, and Minnesota Rules, Chapter 4725. The licensing, construction, and sealing rules apply for the U.S. government, including Forest Service properties, post offices, federal prisons, and other federal properties. The provision in Minnesota Statutes, Chapter 103I, that exempted government agencies from payment of fees was removed effective July 1, 2009. Federal, state, and local governments must now pay all licensing, variance, permit, and notification fees.

## OTHER REGULATIONS

MINNESOTA DEPARTMENT OF NATURAL RESOURCES – An **appropriation permit** is required from the DNR if more than 10,000 gallons per day or 1 million gallons per year is appropriated (removed) from a surface water or groundwater source. Disposal of water, cuttings, or other materials in public waters is regulated by the DNR. The DNR also administers the permit program for underground storage of gas, and administers exploratory boring leases on state properties.

MINNESOTA DEPARTMENT OF AGRICULTURE (MDA) – The MDA regulates water supplies at Grade A and Grade B (manufactured milk) **dairies**, water supplies at facilities which sell **packaged foods**, facilities that **bottle water** in Minnesota, and persons who **chemigate** (the addition of chemicals to an irrigation system). The MDA also is responsible for overseeing clean up of **agricultural chemical contamination**.

MINNESOTA POLLUTION CONTROL AGENCY – The MPCA regulates the **discharge of pollutants** to the environment; air, land, and water. Specifically, the MPCA administers the National Pollutant Discharge Elimination System (NPDES) and State Disposal System Permits; investigates and remediates other releases to the environment, such as spills, leaks from storage tanks and pipelines, releases from the past, unregulated waste disposal activities; and regulates the land application or the underground injection of wastes. Septic systems are regulated by the MPCA and local governments. Handling, storage, and disposal of cuttings at pollution sites come under MPCA regulations. Disposal of cuttings, drilling fluids, and development water may be subject to MPCA regulation. The MPCA may also determine the need for, number, and types of environmental bore holes, monitoring wells, and remedial wells required at a given site.

MINNESOTA DEPARTMENT OF HEALTH, PUBLIC WATER RULES – Rules regulating public water supplies are administered by the MDH, in cooperation with the federal Environmental Protection Agency (U.S. EPA), under the Safe Drinking Water Act.

The public water rules regulate public water supplies. A definition of “public water supply” is found in the definitions section. Rules for public water wells and a discussion of the plan review requirements for community public wells are located in Minnesota Rules, part 4725.5850.

## PLUMBING

The definition of “**plumbing**” includes all potable water supplies and distribution pipes, all plumbing fixtures and traps, all drainage and vent pipes and all building drains, including their respective joints and connections, devices and appurtenances within the property lines of the premises and includes potable water treatment or using equipment.

Previously, the **Minnesota Plumbing Code, Minnesota Rules, Chapter 4715, applied** to potable water or sewage systems:

- That are connected to a municipal water or municipal sewer system;
- That serve facilities licensed by the state or local health offices;
- That serve a considerable number of persons at public facilities such as institutions, factories, office buildings, hotels, apartment buildings, or any place of business; or
- Where a government agency has adopted the Minnesota Plumbing Code or the state building code.

According to the DLI, recent changes to state law extend the Minnesota Plumbing Code **statewide**. Check with the Minnesota Plumbing Board and the DLI for details. Portions of the Minnesota Plumbing Code are found in the appendix.

The **plumbing licensing requirements** apply statewide.

The **plumbing bond** applies to any person contracting to do **plumbing**.

Legislation passed in 2007 required statewide licensing of plumbers, established the Plumbing Board, and created a master and journeyman restricted plumbing license. Previously, licensing was required only in cities with populations of 5,000 or more people. The Plumbing Board now has the authority to create, amend, and interpret the Minnesota Plumbing Code, Minnesota Rules, Chapter 4715. The Plumbing Board consists of members representing the plumbing industry, state agencies, plumbing inspectors, water utilities, and the public. The restricted plumbing license allows persons to do plumbing work in rural areas and in cities with populations of less than 5,000 people. The legislation did not affect the applicability of the plumbing bond.

Licensing of plumbers and inspection of plumbing for public facilities is done by the DLI. Local governments may inspect plumbing in their respective county, township, or city jurisdiction.

The definition of “plumbing” in the Minnesota Plumbing Code includes water supply piping and fixtures such as pressure tanks and yard hydrants routinely installed by well contractors. Meetings have been held with the DLI, Plumbing Board, MDH, and Minnesota Water Well Association (MWWA) to determine what work may be done by a licensed well contractor with a well contractor license who does not have a plumbing license. The DLI and the Plumbing Board have agreed that MDH licensed and bonded well contractors may install a well discharge line (what is referred to in the Minnesota Plumbing Code as a “water service pipe) from a well to a pressure tank, or 2 feet inside the building if there is no pressure tank, without a plumbing license or plumbing bond. The discharge line is regulated in Minnesota Rules, part 4725.5250. The DLI and the Plumbing Board have not made the same determination about additional water lines or installation of frost-proof hydrants, and have said that this work requires a plumbing license.

Laws of Minnesota 2010, Chapter 384 exempts a licensed and bonded well contractor or limited well/boring contractor from the plumbing license and bond for installing water service pipe from a well to a pressure tank or a frost-free water hydrant with an antisiphon device which is located entirely outside of a structure requiring potable water, or a temporary shut-off valve on a well water service pipe for a period not to exceed six months. This law is only effective for one year and does not go into effect until January 1, 2012.

For further information about plumbing and plumbing licensing, please contact the DLI at 651-284-5067.

**DELEGATED WELL PROGRAMS** – The MDH may **delegate the regulation** of water-supply wells, dewatering wells, monitoring wells, elevator borings, and well sealing to local boards of health. The local program and the MDH enter into a delegation agreement. A list of delegated well programs and contacts is included in the appendix. As of 2010, delegated well programs exist in the cities of Bloomington and Minneapolis, and the counties of Blue Earth, Dakota, Goodhue, LeSueur, Olmsted, Wabasha, Waseca, and Winona. At the present time, no local programs have chosen to be delegated elevator borings. Community public water-supply wells are not delegated. Noncommunity public water-supply wells, such as wells serving schools, factories, industries, and day care centers, retail businesses, gas stations, churches, licensed food beverage and lodging facilities, manufactured home parks, children's camps, and campgrounds may be delegated. The delegated well program becomes responsible for permitting, inspection, and enforcement of those portions of the program that are delegated. The MDH does not delegate the licensing and registration of contractors, or the regulation of borings except elevators. The delegated well program has the authority to require a permit where the state would otherwise only require a notification, may raise permit fees higher than the state's, may require separate approval of variances, and may enact more stringent regulations.

Telephone numbers for state agencies and delegated well programs are located in the appendix.

*Subp. 2. **Owner responsibility.** The owner of a well or boring is bound by all the provisions of this chapter that relate to location, construction, maintenance, and sealing of wells or borings.*

Minnesota Statutes, Chapter 103I allows a person to construct a well on property owned or leased by the person only if the **well is used for farming or agricultural purposes** or to serve the person's residence. This allows a property owner to construct an irrigation well, a well for lawn or garden watering, or a well to serve the residence. A property owner may also repair a well which is used for farming or to serve their residence. A property owner may **not** construct wells for other purposes, wells on other properties, borings, monitoring wells, dewatering wells, or any other type of well or boring. A property owner may **not** seal wells or borings. The construction of the well must be in complete conformance with the law (Chapter 103I) and the rules (Chapter 4725). A property owner may install a drive-point well for the purposes stated above without payment of a fee. A drive-point well notification must be filed according to Minnesota Rules, part 4725.1849. If a property owner constructs a well other than a drive-point, a regular notification and fee must be submitted prior to construction.

Minnesota Statutes, Chapter 103I specifically **prohibits a person from placing a contamination source closer to a well** than the minimum isolation distances prescribed in rule. This means that a property owner, neighbor, sewer installer, or any other person may not move any source of contamination closer to an existing well than the distances in these rules. This applies to all water-supply wells regardless of the age of the well. For example, a septic tank cannot be placed within 50 feet of a water-supply well, even if the well was drilled prior to the first well code.

Minnesota Statutes, sections 103I.231, authorizes the commissioner of health to order a property owner to take remedial measures, including making repairs, reconstructing, or sealing a well or boring. In an instance where a well or boring is to be sealed, only a person properly licensed or registered to seal the well or boring may seal the well or boring.

In cases where the owner is not the person responsible for creating a violation (responsible party), the MDH staff have determined that a violation exists and that the responsible party needs to complete corrective actions, and the owner allows the responsible party access for the purposes of completing the corrective actions, the commissioner of health may begin an enforcement action against the responsible party and require the responsible party to complete corrective actions. If the owner does not allow the responsible party access, then the commissioner of health may begin an enforcement action against the owner and require the owner to complete the corrective actions.

*Subp. 3. **Licensee or registrant responsibility.** The licensee or registrant is responsible to:*

- A. verify information and investigate conditions in order to comply with the requirements of this chapter, including the location of contamination sources; and*
- B. provide accurate and truthful information to the commissioner.*

As a knowledgeable and experienced professional in the business of performing well contracting activities, each licensee or registrant is responsible for performing any tests, survey, or investigations that are necessary to assure the accuracy and truthfulness of the information and to assure compliance with the applicable statutes and rules.



The role of MDH staff during an inspection or investigation is review the information provided to the MDH (in addition to any direct knowledge or observation), and based upon the available information make a determination of whether a violation has occurred (not to certify compliance, accuracy, or suitability). In cases where MDH staff determines that a violation has occurred, the commissioner of health has authority to determine the appropriate enforcement actions and determine if there are any corrective actions required.

***Subp. 4. Access to information and property.*** Upon presentation of credentials, the commissioner or an employee or agent authorized by the commissioner, may examine records or data related to matters governed by Minnesota Statutes, chapter 103I and section 144.99, of any person subject to regulation under Minnesota Statutes, chapter 103.I, and, for the purpose of taking an action authorized under statute, rule, or otherwise identified in Minnesota Statutes, section 144.99, subdivision 1, relating to the enforcement of this chapter, may:

- A. enter property to examine the records and data;
- B. inspect equipment and material used in performing wells and borings work;
- C. obtain and analyze water, air, and waste drill cuttings; and
- D. inspect drill holes and drilled, sealed, or repaired wells and borings.

*This authority must be exercised during regular working hours of Department of Health inspectors with respect to inspections of vertical heat exchangers and groundwater thermal exchange devices, and at reasonable times in all other cases.*

The commissioner of health conducts investigations in order to fulfill the duties of protecting public health. In addition to Minnesota Statutes, 103I.101, subdivision 4, (which gives the commissioner of health authority to inspect, collect water samples, and have access, at all reasonable times, to a well or boring site, including wells or borings drilled, sealed, or repaired), Minnesota Statutes, section 144.99, provides authority to obtain other information necessary to complete an investigation.

***Subp. 5. Applicability to delegated well programs.*** This chapter applies within a political subdivision regulating construction, repair, or sealing of wells or elevator borings delegated by the commissioner under Minnesota Statutes, section 103I.111. This does not prohibit a local delegated authority from adopting an ordinance which is consistent with or more restrictive than this chapter.

Minnesota Statutes, section 103I.111, subdivision 1, (a), authorizes the commissioner of health to enter into an agreement with a board of health to delegate all or part of the inspection, reporting, and enforcement duties authorized under provisions of this chapter pertaining to permitting, construction, repair, and sealing of wells and elevator borings. Each local unit of government is responsible for its ordinances, the enforcement of its ordinances, the procedures/processes that it uses for the enforcement of its ordinances, maintaining records of its activities related to the delegated duties, and its legal processes. In instance where a violation is under the jurisdiction of a local delegated program, MDH's role is to provide technical support to the local program and for the MDH to perform periodic review of the local program's records to assure that the local program is at least as stringent as the MDH. The delegated well program may establish fees that are higher than the fees established in Minnesota Statutes, Chapter 103I, as long as the fees do not exceed the costs to administer the program.

STAT AUTH: MS s 103I.101; 103I.221; 103I.301; 103I.621; 144.05; 144.12; 144.383; 156A.01 to 156A.08; 157.04; 157.08; 157.09; 157.13

*HIST: 15 SR 78; 17 SR 2773; 33 SR 211*

#### **4725.0250 ENFORCEMENT.**

Minnesota Statutes, Chapter 103I, and Minnesota Statutes, Chapter 144, establish penalties for violation of the law or rules. Enforcement actions are not taken for contractual disputes, aesthetic water quality issues such as iron or hardness, damage to property, or other activities not specifically regulated by the law or rules.

*Subpart 1. **Enforcement Actions.** The commissioner may take one or more enforcement actions for a violation of this chapter, Minnesota Statutes, chapter 103I, section 144.99 or 144.992, or, including:*

*A. issuing a correction order under Minnesota Statutes, section 144.99, subdivision 3;*

*B. issuing an administrative penalty order requiring a violation to be corrected, and assessing a monetary penalty under Minnesota Statutes, section 144.99, subdivision 4;*

*C. bringing an action for injunctive relief in district court under Minnesota Statutes, section 144.99, subdivision 5;*

*D. issuing a cease and desist order under Minnesota Statutes, section 144.99, subdivision 6;*

*E. denying or refusing to renew an application for a permit, license, registration, or certificate under Minnesota Statutes, section 144.99, subdivision 8;*

*F. suspending, revoking, or imposing limitations or conditions on a permit, certification, license, or registration under Minnesota Statutes, chapter 14, and section 144.99, subdivisions 8 and 9;*

*G. enforcing the requirements of a stipulation agreement, settlement, or compliance agreement provided by Minnesota Statutes, section 144.99, subdivision 1;*

*H. using the license or registration bond to compensate persons injured or suffering financial loss because of the failure of a licensee or registrant to perform work in compliance with duties under this chapter and Minnesota Statutes, chapter 103I;*

*I. requesting prosecution by the county attorney in the county where the violation occurred or is occurring;*

*J. impounding a drilling machine or hoist used by a person who is not licensed or registered according to this chapter and Minnesota Statutes, chapter 103I; and*

### *K. using other remedies afforded by law and rule.*

The goals of an enforcement action are protecting public health and achieving compliance. To achieve these goals the commissioner uses a combination of education, compliance assistance, and an escalating level of enforcement actions. The MDH prefers that violations not occur, and when they do, that the violation be corrected quickly with the minimal amount of legal action. Where the responsible person refuses to make a correction or the violation is severe or repeated, escalated enforcement actions are taken.

The commissioner of health takes an enforcement action against the person or persons responsible for creating the violation (responsible party). The responsible party may be a well or boring licensee, registrant, or certified representative, but in some instances the responsible party is a different type of contractor (such as a plumber, sewer installer, sewage treatment system installer, utility installer, builder, or excavator), a property owner, a well owner, an engineer, or other person.

Under the “Health Enforcement Consolidation Act of 1993” (Minnesota Statutes, sections 144.989 to 144.93), Minnesota Statutes, Chapter 103I, and these rules, the commissioner of health has authority to use a wide range of civil and administrative enforcement actions to assure compliance with Minnesota law. In addition to this specific authority, the commissioner has general authority under administrative law (Administrative Procedures Act) to take administrative enforcement actions. The commissioner of health also has authority to take disciplinary actions against a licensee or registrant (see Minnesota Rules, part 4725.1500)

In determining the appropriate level of enforcement and type of enforcement action, the commissioner of health considers a number of factors, including the gravity or severity, the potential for harm, willfulness, history of past violation, whether the current violation is repetitive, responsiveness or cooperation of the responsible party, and other factors as justice may require. Minor violations or a first time violation may not result in a formal enforcement action and the notice of the violation is given verbally. The notice and results of the investigation are recorded and become part of the regulated party’s enforcement history. In many instances the responsible party works cooperatively with the MDH to resolve the violation. In these instances the MDH uses written correspondence (with a letter such as a Letter of Warning, Notice of Violation, or Notice of Violation/Notice of Correction) to give notice of the violation to the responsible party, and to document with the notice the results of the investigation, the applicable regulations, and what corrective actions need to be, or were, taken in order to bring the matter into compliance.

Some instances or circumstances require that the level of severity of the enforcement action must be increased to obtain compliance or to protect public health. These circumstances include: the responsible party is not cooperating; the responsible party is not completing measures to correct the violation or the corrective actions are unacceptable; the responsible party shows patterns of repetitive or continuing violations; the violation is willful; or the violation is serious. In these instances, one or more of the enforcement actions may include imposing some type of sanction, order, penalty, or other type of relief. Penalties may include: an Administrative Penalty Order (APO) requiring correction of violations, and fines of up to \$10,000; license conditioning, suspension, or revocation; impounding a drilling machine or hoist; civil or criminal prosecution; or use of the bond to correct unlawful performance of work.

In some instances, the commissioner of health determines that a stipulation, settlement, or compliance agreement is the appropriate enforcement tool to resolve the noncomplying conditions. Typically, the parties of an agreement are the responsible party, the owner, and the commissioner of health. The

agreement may require some remedy, partial remedy, time limit, or other condition. A monetary forfeiture (fine) may be required. In most cases, the agreement serves as evidence for the owner that it is the appropriate enforcement tool to resolve the noncomplying conditions. In instances where the owner is not a signatory, the commissioner may execute the agreement with only the responsible party and consider the matter resolved.

Where administrative remedies are not effective, the commissioner refers the matter to the attorney general so that a legal action can be initiated in the appropriate civil court.

If a case appears to warrant criminal prosecution (see Minnesota Statutes, section 103I.715, and Minnesota Statutes, section 144.99, subdivision 11), the commissioner of health or the attorney general may refer the case to the appropriate city or county attorney.

In some instance, another agency or a court orders the MDH to suspend or revoke an individual's "occupational licenses." Suspending or revoking an occupational license includes denying an individual from serving as a licensee's or registrant's certified representative. Where the business entity does not have an alternate certified representative, the licensee or registrant does not have a valid license or registration and cannot perform well contracting activities.

***Subp. 2. Responsibility for correction. The person responsible for creating a violation of this chapter is responsible for correcting the violation. In the case of a violation created or constructed by a licensee or registrant, the licensee or registrant is responsible for correcting the violation. The licensee or registrant who files a notification or obtains a permit for a well or boring is responsible for the well or boring's compliance with this chapter, even if the well or boring construction is subcontracted to another person. A well or boring that cannot be corrected, must be sealed and a complying well or boring constructed, unless the well or boring owner, responsible party, and commissioner agree otherwise in a stipulated agreement.***

The licensee or registrant (licensed or registered contractor, usually a business) is responsible for correction of a violation they caused, not the certified representative. However, for serious or repeated violations, the certified representative may face enforcement actions such as certification suspension or revocation.

The person or persons responsible for creating, or materially directing a violation is (are) responsible for correction. This means that a well contractor who installs a well too close to a sewer is responsible for correction. A sewer contractor who installs a sewer too close to a well is responsible for correction. Plans, designs, and other approvals or information are not generally relevant. For example, if a homeowner incorrectly reports the location of a sewer, and the well contractor drills the well too close without confirming the information, the well contractor will be held at least partly responsible for correction. If a local government grants a permit to place a sewer too close to a well, the sewer contractor who installed the sewer is responsible. This does not preclude the contractor or installer from seeking legal redress against the person or persons who may have contributed to the violation. If a sewer location is specifically identified and the installation directed onsite by an engineer, local government, or other person, both the installer and the person directing the installation will be held responsible.

This rule requires correction and if that is not possible, sealing of the well and construction of a replacement well. Simply sealing the well is not sufficient, unless the contractor, well owner, and MDH agree in a written stipulation agreement.

An enforcement action by the MDH is not a waiver of any other liability, contractual, warrantee, enforcement actions, private rights, cause of action, or remedies of any consumer, state or federal agency, or other person. In instances where the responsible party arranges for another person to complete the corrective actions, the responsible party remains liable for completing the corrective actions. Payment of any penalties, fines, or monetary forfeitures is in addition to any corrective actions and does not remove the responsibility for completing the corrective actions.

***Subp. 3. Time of correction. Correction of a violation of this chapter must be completed under the supervision of the commissioner during normal business hours, within 30 days of notice of the violation, or as specified in an approved variance, work plan, or stipulation.***

Failure to complete corrective actions within the required timeframe or without notifying the commissioner so that an inspection may be made is a violation and may result in the commissioner of health initiating additional enforcement actions, including imposing some type of sanction, order, penalty, or other type of relief. Failure to correct a violation after the first notice may be the basis for considering a violation a repeat violation during subsequent inspections or investigations.

***STAT AUTH: MS s 103I.101, 103I.111; 103I.205; 103I.221; 103I.301; 103I.401; 103I.451; 103I.501, 103I.531; 103I.535, 103I.541, 103I.621  
HIST: 33 SR 211***

***4725.0300 [Repealed, 17 SR 2773]***

***4725.0350 FEES APPLICABLE TO THIS CHAPTER.***

***Subpart 1. Applicability. The fees specified in Minnesota Statutes, chapter 103I apply to this chapter, except:***

***A. that a federal agency, state agency, or local unit of government is exempt from payment of the fees, and***

This has been superseded and made void by Laws of Minnesota, 2009, Chapter 79, that removed the government fee exemption. Federal, state, and local governments must pay all license, variance, permit and notification fees with some exemptions. Federal (not state) military bases are exempt from fees and regulation. Native American reservations are exempt from fees and regulation. Remediation work on federal superfund sites is exempt from fees.

***B. for notification and permits regulated by a board of health delegated under Minnesota Statutes, section 103I.111.***

*Fees are not refundable, except as specified in part 4725.1836.*

All fees are in Minnesota Statutes, Chapter 103I.

A table summarizing the fees is located at the end of this rule part.

### **GOVERNMENT FEE EXEMPTION REMOVED**

Minnesota Statutes, Chapter 103I, **formerly exempted federal agencies, state agencies, and local units of governments from all fees** required by Minnesota Statutes, Chapter 103I, or Minnesota Rules, Chapter 4725. This exemption was removed, July 1, 2009.

### **NOTIFICATION REFUND EXCEPTION**

An exception has been made for the refund of water-supply well construction notifications. A refund will be made to whoever paid a notification when a water-supply well is **not** drilled, and when the refund request is made in writing within 18 months of the initial construction notification. Refunds will not be made if any drilling has taken place (including drilling a dry hole), or if the refund is requested after the 18 month period. Refunds will be made only for water-supply well notifications; not for other types of wells or borings, or for other fees. If a notification is paid by a well contractor and the property owner hires another contractor to drill the well, the notification fee may not be transferred. The contractor must request a refund.

### **NO BORING SEALING FEE**

There is no fee for sealing any boring.

### **NO ENVIRONMENTAL BORE HOLE FEE**

There is no fee required to construct or seal an environmental bore hole.

### **DELEGATED WELL PROGRAM FEES**

Local delegated programs may charge higher construction, sealing and maintenance fees, may require a permit instead of a notification, and may charge fees for additional activities not prohibited by statute. Local programs may not charge a license or registration fee.

*Subp. 2. **Qualification application fee.** A nonrefundable fee as specified in Minnesota Statutes, chapter 103I, must be submitted to apply for qualification and examination for licensure as an individual well contractor as specified in part 4725.0475, subpart 3, or certification as a representative for any of the following:*

This is an application fee for certification as a representative or licensure as an individual well contractor. An additional license fee is required to become an individual well contractor, or for a business to be licensed or registered.

- A. a well contractor as specified in part 4725.0475, subpart 3;
- B. a limited well/boring contractor as specified in part 4725.0475, subpart 4;
- C. an elevator boring contractor as specified in part 4725.0475, subpart 5; or
- D. a monitoring well contractor as specified in part 4725.0475, subpart 6.

**Subp. 3. License or registration fees.** An application for an original or renewal license or registration must be accompanied by a nonrefundable license or registration fee as specified in Minnesota Statutes, chapter 103I.

This fee is for a well contractor license, limited well/boring contractor license, monitoring well contractor registration, or individual well contractor license. It is not a (second) fee for the certified representative.

There are six categories of limited well/boring contractor license: pumps and pumping equipment, screen/pitless, dug well/drive-point well, dewatering well, vertical heat exchanger, and well sealing. A separate \$75 fee is required for each license, with a cap of \$225 for three or more limited licenses. A single bond can cover a licensee with multiple limited licenses. In cases of multiple licenses/registrations, the bond amount is determined by the license/registration with the highest bond amount.

Minnesota Session Laws 2009, Chapter 101, SF 2082, article 2, section 59, established a surcharge on all licenses, effective from July 1, 2009, to June 30, 2015. Ten percent (10 percent) of each license fee must be sent to the state chief information officer in the Office of Enterprise Technology (OET) for the electronic licensing system. The total fee and surcharge for the licenses now (2010) at \$75 increase to \$82.50, and the well contractor license fee and surcharge increase to \$275. The monitoring well contractor registration is not a “license,” so the surcharge does not apply.

The rules regarding activities requiring a license are located in Minnesota Rules, part 4725.0475. The rules regarding license or registration experience requirements are located in Minnesota Rules, part 4725.0650. The rules concerning application for licensure or registration are found in Minnesota Rules, part 4725.1075.

**Subp. 4. License or registration late renewal fee.** If a licensee or registrant fails to submit all information required for the renewal of a license or registration or submits the application and information after the required renewal date as specified in part 4725.1300, a late fee as specified in Minnesota Statutes, chapter 103I must be paid in addition to the fees specified in subpart 3.

Licenses expire on January 31 and monitoring well contractor registrations expire on December 31. Applications received or postmarked after the expiration date must submit the additional \$75 late fee.

**Subp. 5. Notification fees.** A notification fee as specified in Minnesota Statutes, chapter 103I, must be paid by a property owner or the owner’s agent for:

- A. each new water-supply well constructed;
- B. each dewatering well constructed, or for a dewatering project comprising five or more dewatering wells; and

*C. each well sealed, or for sealing multiple monitoring wells located on a single property with depths varying by no more than 25 feet that are sealed within 48 hours of the start of construction.*

The general notification rules are located in Minnesota Rules, parts 4725.1810 through 4725.1825. The well sealing notification rules are located in Minnesota Rules, part 4725.1832.

*Subp. 6. Permit fees. A nonrefundable permit fee as specified in Minnesota Statutes, chapter 103I must be paid by a property owner or owner's agent:*

*A. annually for a water-supply well that is not in use and under a maintenance permit;*

*B. for construction of a monitoring well;*

*C. annually per well for a monitoring well that is unsealed and under a maintenance permit;*

*D. per site for construction of all monitoring wells, regardless of number, used as leak detection devices at a single motor fuel retail outlet, a single petroleum bulk storage site excluding tank farms, or a single agricultural chemical facility site;*

*E. for construction and injection of water by a groundwater thermal exchange device in addition to the notification fee specified in subpart 5;*

*F. for construction of a vertical heat exchanger;*

Minnesota Statutes, Chapter 103I, was amended, effective July 1, 2009, to establish increased fees for larger vertical heat exchanger systems. Systems with less than 10 tons of heating/cooling capacity stay at \$215. The permit fee for systems with 10 to 50 tons heating/cooling capacity is \$425. The permit fee for systems with greater than 50 tons of heating/cooling capacity is \$650.

*G. annually for a dewatering well that is unsealed and under a maintenance permit except that a dewatering project comprising more than five wells shall be issued a single permit for wells recorded on the permit; and*

Minnesota Statutes, Chapter 103I, was amended in 1994 to replace the dewatering well construction permit with a notification.

*H. for construction of a boring to install an elevator hydraulic cylinder.*

The permit requirements are located in Minnesota Rules, parts 4725.1810 through 4725.1848

*Subp. 7. Drilling machine registration fee. A person must not use a drilling machine unless a nonrefundable fee as specified in Minnesota Statutes, chapter 103I, is paid annually to register the drilling machine.*

The rules relating to drilling machine registration are located in Minnesota Rules, parts 4725.1700 and 4725.1800.



**Subp. 8. Hoist registration fee.** *A person must not use a hoist unless a nonrefundable fee as specified in Minnesota Statutes, chapter 103I, is paid annually to register the hoist.*

The rules relating to hoist registration are located in Minnesota Rules, parts 4725.1700 and 4725.1800.

**Subp. 9. Well disclosure fee.** *According to Minnesota Statutes, section 103I.235, a nonrefundable disclosure fee as specified in Minnesota Statutes, chapter 103I, shall be collected.*

The requirements for well disclosure are contained in Minnesota Statutes, sections 103I.235 through 103I.236. The rules do not contain requirements for disclosure other than the fee. A short description of disclosure is contained in the comments after Minnesota Rules, part 4725.3850.

**Subp. 10. Variance fee.** *A nonrefundable fee as specified in Minnesota Statutes, chapter 103I, shall be charged by the commissioner to request a variance from this chapter.*

The variance rules are contained in Minnesota Rules, part 4725.0410, and Minnesota Rules, Chapter 4717.

**Subp. 11. Electronic payment.** *Notification and permit fees for construction and sealing may be paid electronically.*

Notifications for water-supply well and dewatering well construction and sealing, and permit applications for elevator borings and monitoring wells may be submitted by facsimile (FAX), with payment by credit card (see Minnesota Rules, part 4725.1836).

Fees for license or certification qualification applications, license/registration applications or renewals, permits for vertically heat exchangers or groundwater thermal exchange devices, and variance request applications may not be paid by credit card. These fees may be paid by (valid) check, money order, or cash.

**STAT AUTH:** *MS s 103I.101; 103I.111; 103I.205; 103I.221; 103I.301; 103I.401; 103I.451; 103I.525; 103I.531; 103I.541; 103I.621; 144.122;*  
**HIST:** *18 SR 1222; 33 SR 211*

## 2010 Fee Schedule Well Management Section

Fee Type	Fee Effective July 1, 2009
<b>Well Construction Notification</b>	
Water-supply wells .....	\$215
Dewatering well .....	\$215
Dewatering project (more than five wells on a site) .....	\$1075
<b>Well Sealing Notification</b>	
<b>Water-supply, monitoring, dewatering</b> .....	\$50
Temporary monitoring well site .....	\$50
<b>Construction Permit</b>	
Elevator boring .....	\$215
Groundwater thermal exchange device .....	\$215
Vertical heat exchanger (loop) less than 10 tons .....	\$215
Vertical heat exchanger, 10 to 50 tons .....	\$425
Vertical heat exchanger, greater than 50 tons .....	\$650
Monitoring well .....	\$215
Monitoring well site* .....	\$215
<b>Maintenance Permit (annual fee)</b>	
Water-supply well maintenance, not in use well .....	\$175
Monitoring well maintenance (after 14 months) .....	\$175
Monitoring well maintenance, government owned .....	\$50
Dewatering well maintenance (after 14 months) .....	\$175
Dewatering well project maintenance (after 14 months) .....	\$875
<b>Variance Application</b> .....	\$215
<b>Well Disclosure Certificate**</b> .....	\$45
<b>License/Registration Fee***</b>	
Qualification application .....	\$75
Responsible individual (Explorer) .....	\$75
Renewal, late .....	\$75
Elevator contractor .....	\$75
Explorer Company .....	\$75
Limited well/boring contractor .....	\$75
Monitoring well contractor .....	\$75
Well contractor .....	\$250
Hoist/drilling machine registration .....	\$75
<b>Core Function (delegated programs)</b>	
Well construction .....	\$20
Well sealing .....	\$5

\* Monitoring well site permits include motor fuel retail outlet sites, petroleum bulk retail storage sites, and agricultural chemical retail facilities.

\*\* \$7.50 is retained by the County Recorder.

\*\*\* Minnesota Session Laws 2009, Chapter 101, SF 2082, article 2, section 59, established a surcharge on all licenses, effective from July 1, 2009, to June 30, 2015. Ten percent (10 percent) of each license fee must be sent to the Minnesota electronic licensing system. The total fee and surcharge for the licenses now at \$75 will increase to \$82.50, and the well contractor license fee and surcharge will increase to \$275.

Previous state law exempted governments from the requirement to pay fees. This exemption was removed, effective July 1, 2009. Federal, state, and local governments must now pay all fees including variance, notification, and maintenance permit fees.

**4725.0400 [Repealed, 15 SR 1597]**

**4725.0410 VARIANCE.**

**Subpart 1. General.**

*A. The commissioner shall grant a variance to any provision of this chapter according to the procedures and criteria specified in parts 4717.7000 to 4717.7050.*

*B. A person requesting a variance must submit a written request on a form prescribed by the commissioner, along with the nonrefundable fee as required in Minnesota Statutes, chapter 103I.*

*C. A variance application for a well or boring located in the jurisdiction of a delegated program must be submitted, along with the fee as specified in Minnesota Statutes, chapter 103I, to the commissioner. The delegated program may require a separate application and fee.*

*D. A variance must be applied for and granted prior to commencing the activity for which the variance is requested.*

*E. An application submitted without the information required by this part and parts 4717.7000 to 4717.7050 shall be denied 18 months after the date received by the commissioner.*

*F. Construction, and the conditions of a granted variance, must be completed within 18 months of variance approval, or the variance is void, unless conditions of the variance specify otherwise.*

The MDH has adopted a **general variance rule** which applies to all variance requests for all of the MDH rules. These general requirements are found in Minnesota Rules, Chapter 4717, which is included in the appendix.

Specific requirements for variances from this rule (Minnesota Rules, Chapter 4725) are found in this rule part.

Variance applications must contain the information required in Minnesota Rules, Chapter 4717, and Chapter 4725.

A summary of the variance process and requirements is located at the end of this rule part.

The variance application form is available electronically as a PDF file at the MDH Well Management Section Web site at: [www.health.state.mn.us/divs/eh/wells/lwcinfo](http://www.health.state.mn.us/divs/eh/wells/lwcinfo).

The variance fee is \$215 and is not refundable.

**Subp. 2. Requests for construction, repair, or sealing variance.** In addition to the information required in part 4717.7000, subpart 2, the applicant must submit to the commissioner, in writing, the following information for a request to vary a construction, repair, or sealing provision related to wells or borings in parts 4725.2010 to 4725.7450:

- A. the location of the well or boring in terms of the township number, range number, section number, three-quarter sections, and the street address if assigned;
- B. the unique number, if assigned;
- C. the name, address, and telephone number of the contractor doing work, the property owner, and the well owner;
- D. a scaled map showing the location of the well or boring in relation to all property lines, structures, utilities, and contamination sources cited in part 4725.4450;
- E. the proposed depth of the well or boring;
- F. the casing type, its diameter, and its depth;
- G. a description of the method of construction, grout materials, and method of emplacement;
- H. a description of the anticipated geologic conditions;
- I. the depth to water, pumping rate, number of persons served by the well, and a description of the use of the well; and
- J. information on special construction methods, safety measures, or precautions proposed to protect public health, safety, and the environment.

The variance request must be signed by the owner of the well or boring if the request involves a well or boring, the property owner if the well or boring owner and property owner are different persons, and the certified representative of the contractor if there is work being done by a well or boring contractor.

The variance request must be **submitted in writing**. Variances cannot be granted “after the fact.” That is, a variance must be approved prior to construction. The request must contain the \$215 fee and the information listed above. Additional information is required by Minnesota Rules, Chapter 4717, which is located in the appendix and is summarized at the end of this rule part.

Variance requests that do not contain the required information will be returned, and the variance not acted upon until the information is complete. After 18 months, an incomplete variance application request will be denied.

**Subp. 3. Additional standards for variance request from isolation distance.** In addition to the information in subparts 1 and 2, a variance request to part 4725.4450 must include:

- A. information on special construction methods or precautions proposed to prevent contamination of the well and groundwater;
- B. a description of the age, design, size, and type of construction of any existing or potential contamination source as specified in part 4725.4450;

C. any testing, inspection, or certification data and the name and address of the person supplying the data;

D. information on soil type from a soil survey, percolation test, or soil boring report; and

E. a copy of any review of contamination sources done by a local or state unit of government under other applicable regulations.

**Subp. 4. Additional standards for variance to be placed on a deed.** In addition to the information in subparts 1 and 2, a variance to be placed on a real property deed must include:

A. the complete name(s) of the fee owner(s) as the name(s) appears on the deed;

B. the property identification number;

C. the Torrens certificate number if the property is Torrens property; and

D. the legal property description.

**Subp. 5. Emergency variances.**

A variance may be verbally granted by the commissioner in an emergency where a delay in starting work poses an immediate and significant danger to health or safety.

A. The person applying for the variance must submit a completed application and fee to the commissioner prior to receiving approval.

B. Verbal approval must be given by the commissioner prior to starting construction.

C. Construction must be in accordance with conditions verbally reported.

D. The emergency variance shall be void if construction is not started within 72 hours of verbal approval.

E. All construction and location standards in this chapter, except those specifically modified under the variance, shall apply to wells and borings constructed under an emergency variance.

F. The commissioner shall not issue an emergency variance to persons who have violated the emergency variance requirements.

### **EMERGENCY VARIANCES**

Emergency variances may be obtained when public health or the environment are at immediate risk. Emergency situations may include cases where failure to begin work results in contamination of a well, boring, or groundwater; where failure of an existing water supply presents an immediate health risk to livestock or people; or where delay will result in the endangerment of health or safety.

A request for an emergency variance will not be approved until after the written variance application and applicable fee have been submitted to the MDH. The variance request will be reviewed by MDH Well Management Section district staff, in consultation with the manager of the Well Management Section. Construction may start upon receipt of verbal approval from the Well Management Section manager.

## DELEGATED WELL PROGRAM VARIANCES

Both the MDH and the delegated well program must review a variance request for a regulated well or boring located in a county or city with a delegated well program. The variance request should be submitted to the MDH. The MDH will forward a copy of the variance request to the delegated well program, and will arrange for a site inspection, typically jointly with the delegated well program staff. After consultation with the delegated well program, the MDH will prepare a letter that approves, approves with conditions, or denies the variance request.

Approvals are handled in one of two ways, depending on the delegated well program. For most delegated well programs (city of Bloomington; city of Minneapolis; Blue Earth County, LeSueur County, Olmsted County, and Waseca Counties), the MDH will send an approval letter directly to the applicant(s), with a copy sent to the delegated well program. For the remainder of the delegated well programs (Dakota County, Goodhue County, Wabasha County, and Winona County), the MDH will send a letter to the delegated well program recommending that the variance be approved. The delegated well program then has the option to approve the variance as written by the MDH, approve the variance with additional conditions, or deny the variance request. A delegated well program may not grant a variance unless the MDH has first recommended approval of the variance request.

If a variance request is denied by the MDH, the denial letter is sent directly to the applicant(s). A delegated well program may not grant a variance that has been denied by the MDH.

The delegated well program may charge an additional variance fee, require submission of additional documentation, and impose additional conditions on a variance approval.

## VARIANCE PROCESS

Variations are only granted when **issuance of the variance protects the public health and groundwater and only in cases of unusual hardship or circumstance**. Variations have not been granted for convenience, aesthetics, or where the rules can be physically and reasonably met. A variance cannot be granted after a violation of rule or statute has occurred. A variance request will not be processed until the MDH receives the fee, a written variance application signed by the party requesting the variance and the contractor, and the accompanying documentation and supporting information. A person has a right to apply for a variance. We encourage persons who believe they may need to variance to contact the MDH. The MDH will be available to consult and in most cases make a preliminary investigation and assessment prior to completing the formal request and submitting the fee. This may reduce the time for processing, or this may result in finding an alternative solution that does not require a variance.

Upon receiving the variance request, the MDH will attempt to process the request within two weeks. A field inspection will be conducted by MDH staff along with interviews of concerned and affected parties including local governmental officials. The documentation and justification submitted by the party requesting the variance will be reviewed. All variance requests must be reviewed and signed by the manager of the Well Management Section before they are in force. The request will be approved, denied, or approved with conditions. An approval or denial letter will be sent to the person who requests the variance. A denial may be appealed by pursuing a contested case hearing. Hearing costs are paid by the agency unless the request is frivolous, in which case the MDH may ask the judge to assess costs to the applicant. The applicant does not have to be represented by legal counsel, but the MDH will be represented by an assistant attorney general.

## VARIANCE REQUEST SUMMARY REQUIREMENTS AND PROCEDURES

### GENERAL INFORMATION

- Variances may be granted to any requirement of Minnesota Rules, Chapter 4725.
- Variances may not be granted to state law, including Minnesota Statutes, Chapter 103I.
- Variances shall only have future effect. In other words, after-the-fact variances will not be granted.
- Variances may **only** be granted **in writing** by the MDH. Verbal approval for an emergency variance, as previously described, will be followed with a written approval detailing the agreed upon terms and conditions.
- Variances in counties or cities which currently have a well program delegation agreement (Blue Earth, Dakota, Goodhue, LeSueur, Olmsted, Wabasha, Waseca, and Winona counties, and the cities of Bloomington and Minneapolis) must be approved by both the delegated well program and the MDH. However, in some cases the MDH sends a single approval letter that includes the local approval. The variance request must be submitted to the MDH prior to, or at the same time as, the delegated well program.
- A variance request and approval does not eliminate the need to submit a notification or obtain a permit.

### PROCEDURES FOR REQUESTING A VARIANCE

- The party requesting the variance must submit the variance request in writing to the MDH Well Management Section along with any applicable fee.
- All variance requests must contain the following:
  - The name, address, telephone number, and signature of the person(s) requesting the variance; the well and property owner if different; and the contractor doing the work;
  - The language in the rule from which the variance is requested;
  - The reasons that the rule cannot be met, with supporting evidence;
  - The alternative or protective measures that will be taken to assure a comparable degree of protection to health or the environment if a variance is granted;
  - The length of time for which the variance is requested;
  - A statement that the party applying for the variance will comply with the terms of the variance, if granted;
  - The nonrefundable \$215 fee; and the permit or notification fee; and
  - Other relevant information the commissioner determines necessary to properly evaluate the request for the variance.
- Additional information required for variance requests concerning the construction, repair, or sealing of a well or boring:
  - The location of the well or boring in terms of township, range, and three quarter sections;
  - The unique number if one has been assigned;
  - The name, address, and telephone number of the contractor doing the work; the property owner; and the well or boring owner if different from the property owner;
  - A scaled map showing the location of the well or boring; in relation to the property lines;
  - Structures, utilities, and contamination sources cited in the rules;
  - The proposed depth of the well or boring;
  - The casing type, its diameter, and its depth;
  - A description of the method of construction, grout materials, and method of emplacement;
  - Description of the anticipated geologic conditions; and
  - The depth to water, pumping rate, number of persons served by the well, and a description of the use of the well.

- Additional information required for variance requests to modify the contamination source isolation distance requirements:
  - Information on special construction methods or precautions proposed to prevent contamination of the well, boring, or groundwater;
  - A description of the age, design, size, and type of construction of any existing or potential contamination sources;
  - Any testing, inspection, or certification data; and the name and address of the person supplying the data;
  - Information on the soil type from a soil survey, percolation test, or soil boring report; and
  - Copy of any review of contamination sources done by a local or state unit of government under other applicable regulations.

#### CRITERIA FOR DECISION; CONDITIONS

The commissioner may grant a variance if:

- The variance was requested in the manner prescribed;
- The variance will have no potential adverse effect on public health, safety, or the environment;
- The alternative measures to be taken, if any, are equivalent to or superior to those prescribed in the rule;
- Strict compliance with the rule will impose an undue burden on the applicant; and
- The variance does not vary a statutory standard.

#### NOTIFICATION OF DECISION

The commissioner of health shall notify the party in writing of the commissioner's decision to grant or deny the variance. If a variance is granted, the notification must specify the period of time for which the variance will be effective and the alternative measures or conditions, if any, the applicant must meet. If a variance is denied, the commissioner of health shall specify the reasons for the denial.

#### EFFECT OF ALTERNATIVE MEASURES OR CONDITIONS

Alternative measures or conditions attached to a variance have the force and effect of the applicable rule. If the party violates the alternative measures or conditions attached to the variance, the party is subject to the enforcement actions and penalties provided in the applicable law or rule. The party to whom a variance has been issued must notify the commissioner of health in writing within 30 days of any material change in the conditions upon which the variance was granted.

#### RENEWAL OF VARIANCE

A request for the renewal of a variance must be submitted to the commissioner of health in writing 30 days before its expiration date. Renewal requests must contain the information required under "Procedures for Requesting a Variance." The commissioner shall renew a variance if the party continues to satisfy the criteria for granting the variance and demonstrates compliance with the alternative measures or conditions imposed at the time the original variance was approved. This provision does not apply if there has been any material change in the conditions upon which the variance was granted.

#### DENIAL, REVOCATION, OR REFUSAL TO RENEW; APPEALS

The commissioner shall deny, revoke, or refuse a variance if the commissioner determines that the above criteria are not met. A party may formally appeal the denial, revocation, or refusal to renew a variance by requesting, in writing, a contested case hearing under the Administrative Procedure Act, Minnesota Statutes, Chapter 14, within 30 days of receipt of the notice to deny, revoke, or refuse to renew the variance.



SUBMITTAL OF VARIANCE REQUESTS

Variance requests should be submitted to the:

Minnesota Department of Health  
Well Management Section  
ATTN: Variance Requests  
P.O. Box 64502  
St. Paul, Minnesota 55164-0502

*STAT AUTH: MS s 14.05; 103I.101; 103I.111; 2103I.205; 103I.221; 103I.301;  
103I.401; 103I.451; 103I.501; 103I.525, 103I.535, 103I.541, 103I.621; 144.05;  
144.12; 144.122; 144.383; 157.04; 157.08; 157.09; 157.13*

*HIST: 15 SR 1597; 17 SR 2773; 18 SR 1222; 33 SR 211*

***4725.0450 [Repealed, 17 SR 2773]***

## **LICENSING AND REGISTRATION**

### **4725.0475 ACTIVITIES REQUIRING LICENSURE OR REGISTRATION.**

Minnesota law requires that a person who constructs, repairs, or seals a well or boring have a license or registration from the MDH. The “person” who is licensed or registered is the business entity, usually a corporation, limited liability partnership, or other legal entity. Each licensed or registered entity must have at least one person (certified representative) to act on behalf of the business (licensee or registrant). The representative must meet certain requirements for education and/or experience in order to become certified, and must annually obtain continuing education. The licensee or registrant (company) must maintain a bond, register all drilling machines and hoists used for regulated work, and annually renew the license or registration.

*Subpart 1. Activity requiring licensure or registration. Except for those persons exempted under Minnesota Statutes, section 103I.205, subdivision 4, paragraph (e), a person must hold a license or registration to:*

A copy of **Minnesota Statutes, Chapter 103I (2008), is located in the appendix.** The law allows a person to construct a well (without being licensed) on property owned or leased by the individual if the well is used for farming, agricultural purposes, or to supply water to the residence [see Minnesota Statutes, section 103I.205, subdivision 4 (e)]. This does not allow the person to drill a well or boring for any other purpose. For example, a property owner cannot construct their own monitoring well, or a well for a business. The law also clarifies that someone working for (an employee of) a licensed or registered contractor does not have to be licensed if the contractor is licensed or registered. The law requires that all construction be in conformance with the law and rules whether the well is personally constructed by a certified representative, an employee of a licensed contractor, or a property owner.

These rules regulate the construction, repair, and sealing of wells and borings as these terms are defined in statute and rule. Other excavations in the ground, which are sometimes referred to as “wells” or “borings” are not regulated unless they meet the definitions. Cathodic protection holes, footing holes, caissons, and gravel exploration holes are not regulated by these rules. However, it is recommended that the rules be followed. Holes drilled to explore or prospect for oil, natural gas, apatite, diamonds, graphite, gemstones, kaolin clay, or metallic minerals are regulated as exploratory borings under Minnesota Rules, Chapter 4727.

### **LICENSE OR REGISTRATION NOT REQUIRED**

A well or boring license or registration is **not** required to:

- Prime a pump
- Repair a pump which has been removed from a well;
- Repair a jet pump or turbine motor where the pump is not directly attached to a casing;
- Obtain a water sample from a well;
- Fill in a well pit as long as the well casing has been extended above ground or the well has been sealed and the well pit is not a dug well; or
- Install protective posts around a monitoring well or other type of well.

*A. construct, repair, modify, or seal a well or boring;*

A person licensed or registered to construct a particular type of well or boring may seal that type of well or boring.

*B. construct or seal a vertical heat exchanger or groundwater thermal exchange device;*

*C. construct, repair, or seal an elevator boring;*

*D. install a well pump or pumping equipment;*

A person licensed or registered to construct a particular type of well may install a pump in that type of well.

A license or registration is required to install and remove a well pump or pumping equipment, including jet pumps.

*E. install, modify, or remove a screen, pitless unit, or pitless adapter; or*

A license is also required to remove a screen, pitless unit, or pitless adapter.

*F. modify or materially affect the yield, water quality, diameter, depth, or casing of a well or boring including:*

*(1) attachment of water conditioning or other devices to the casing of the well or boring;*

*(2) chemical treatment of the well or boring with acid or other chemicals;*

*(3) development or stimulation of a well or boring including the use of explosives or hydrofracturing; or*

*(4) termination of a monitoring well, environmental bore hole, remedial well, or dewatering well casing at-grade, including installation or modification of the protective manhole or vault as required in part 4725.6850.*

**Modify or materially affect the yield** includes: development, stimulation, hydrofracturing, blasting and bailing, gravel packing, chemical or other in-well treatment, cleaning out debris or fill, redrilling a well or boring, installation or removal of a pump, or grouting a portion or all of a well or boring.

**Modify or materially affect the water quality** includes: addition of chemicals on a one-time basis or on a regular or continuous basis; attaching or connecting water conditioning or treatment devices to a well or boring; or attaching devices to inject air, reinject water, or add or remove other materials.

**Modify or materially affect the diameter, depth, or casing** includes: addition or removal of casing, screen, or pitless; drilling or redrilling the well or boring; connecting devices to the casing; welding onto or drilling, cutting into the casing, including drilling or cutting to attach electrical grounding devices.

Persons may do the activities in subitems (1) through (3) on the type of well or boring they are licensed or registered to construct and seal. In addition, licensed pump installers and well screen/pitless installers may also do these activities.

A well contractor license is not required to attach a **water conditioning device** to the water discharge line outside the casing. However, this is regulated under the plumbing licensing program of the DLI. A licensed or registered well contractor must make any connection into a well. Installation of **in-well treatment devices** on public water-supply wells must be approved by the MDH. In-well treatment devices, such as pellet chlorinators, are not recommended to be installed on public or private water-supply wells.

The rules do not specify standards for the operation, design, or maintenance of water conditioning devices. The rules do regulate who may attach them to a well or boring and how that attachment is made. This requirement also applies to other devices or connections to the casing such as **electrical grounds**. An unlicensed person, including an electrician, cannot legally drill holes into, or otherwise modify, a casing. The practice of drilling a hole into the casing to attach a ground wire for a submersible pump is prohibited. All modifications and connections to a casing must be made by a licensed or registered well or boring contractor.

Chemical treatment, including chlorination, must be done by a licensed person. Except that, chlorination of a public well may be done by the operator of the public system, and the owner and resident of a property with a well used to supply the residence or used for farming may chemically treat the well.

**Development** is the process of removing drilling fluids, formation fines, and mineral materials smaller than a screen opening in order to produce a clear water sample, increase yield and stabilize the screen. Development must be done by a licensed or registered contractor.

A **pumping test** is done to measure hydrologic properties. Only licensed or registered contractors may install a pump to conduct a pumping test. However, a license is not required to operate a pump or to measure water levels.

A **stabilization test** is done after a well is developed and periodically records parameters in order to obtain a water sample representative of the aquifer.

A stabilization test may be conducted by an unlicensed person to the extent that a pump is turned on or off and water samples are collected. A stabilization test is not done to remove fines or drilling fluid. A licensed or registered contractor must install or remove a pump or modify a well or boring.

**Hydrofracturing** or “hydrofracing” is the process of pressurizing a rock formation to create, connect, or widen fractures which will increase water yield.

*Subp. 2. Exceptions to licensure or registration. Nothing in this part shall prohibit:*

*A. a person from placing a water sampling device including a well pump or pumping equipment in a monitoring well or remedial well to obtain a water sample if the device is immediately removed after the sample is collected;*

This exemption does not allow an unlicensed or unregistered person to develop a well or to install a pump for water supply purposes or pump testing.

“**Immediately removed**” means that the sampling device is placed in the well, a sample is removed, or a number of samples are removed during a single sampling event, and the sampling device is removed. The person placing the sampling device in the well is responsible for replacement of the well cap or seal.

*B. a plumber or plumbing contractor from installing and servicing a water service pipe according to chapter 4715, from the source of supply;*

A plumber may install and service a water service line between a well and a building, according to the Minnesota Plumbing Code, part 4715.1710. A plumber may not install, repair, or service a pitless unit or adapter or any portion of the casing. A plumber may not install or repair a well pump or pumping equipment.

*C. a water conditioning contractor from installing water conditioning equipment within a building according to chapter 4715;*

The Minnesota Plumbing Code, parts 4715.5000 to 4715.6000 prescribe minimum standards and procedures for water conditioning.

This exemption does not apply to attachment of water conditioning devices to the casing. In-well treatment devices such as pellet chlorinators are not recommended to be installed, however, if they are, the installation must be done by a licensed well contractor.

*D. a limited well/boring contractor from repairing, installing a pump or pumping equipment, or repairing or sealing a well that the limited well/boring contractor is licensed to construct; and*

Subpart 4 of this rule part explains the limited license activities. Also, see the licensing summary after Minnesota Rules, part 4725.1800.

*E. a water-supply system operator certified under chapter 9400 or the owner of a transient, noncommunity water system from disinfecting the public well they are directly responsible for, according to part 4725.5550.*

Water-supply system operators for community and nontransient noncommunity systems are certified by the MDH Drinking Water Protection Section, under Minnesota Rules, Chapter 9400.

***Subp. 3. Well contractor license. A person must be licensed as a well contractor to:***

***A. construct, repair, modify, or seal a well or boring except exploratory borings;***

**Exploratory borings** (drilling done to prospect for oil, natural gas, apatite, diamonds, graphite, gemstones, kaolin clay, or metallic minerals) must be done by a licensed explorer. A well contractor may not drill exploratory borings without an explorer's license. Minnesota Rules, Chapter 4727, explains the requirements to obtain an explorer's license.

- B. install a pump or pumping equipment; and*
- C. any of the activities in subpart 1, item F.*

The summary after Minnesota Rules, part 4725.1800 explains which activities can be performed with each license or registration.

*Subp. 4. Limited well/boring contractor licenses. A person performing any of the activities in items A to F must have either a well contractor's license or have a separate limited well/boring contractor license for each of the limited licensure areas listed in items A to F:*

*A. limited licensure to construct, repair, modify as specified in subpart 1, item F, or seal a dug well or drive-point well;*

*B. limited licensure to install, modify, or repair screens, pitless units or adapters, and casings from the frost line or pitless unit or adapter to the upper termination of the casing;*

*C. limited licensure to install a well pump or pumping equipment, or any of the activities in subpart 1, item F, subitems (1) and (2);*

A well contractor or pitless license is required to install an underground connection (pitless). A pump installer may not install a pitless or otherwise modify the casing, unless the person also holds a pitless license.

### **PLUMBING AND WELL WORK**

Prior to 2007, a plumbing license was required only in cities with populations of 5,000 or more. Amendments to the plumbing licensing law in 2007 required that any person doing plumbing anywhere in the state must have a plumbing license. The law established a restricted license with an application process that sunsetted in 2008. However, an amendment to the law opened the application process for two weeks in October 2009. The law has required that a person who does plumbing have a plumbing bond. "Plumbing" is defined as water and sewer piping and fixtures within the property boundaries. As such, well discharge lines and yard hydrants are included in the definition of plumbing.

The well rules regulate a water discharge line from the well to the pump controls. The well rules do not regulate additional waterlines or plumbing fixtures such as yard hydrants, faucets, or stock waterers. As such, the DLI and the Minnesota Plumbing Board have determined that a MDH licensed and bonded well contractor may install a water discharge line up to a pressure tank or 2 feet inside a building if there is no pressure tank, and are not required to have a plumbing bond or license. However, the Plumbing Board and the DLI have determined that installation of frost-proof yard hydrants, other fixtures, or other waterlines must be done by a licensed plumber. Laws of Minnesota 2010, Chapter 384 exempts a licensed and bonded well contractor or limited well/boring contractor from the plumbing license and bond for installing water service pipe from a well to a pressure tank or a frost-free water hydrant with an antisiphon device which is located entirely outside of a structure requiring potable water, or a temporary shut-off valve on a well water service pipe for a period not to exceed six months. This law is only effective for one year and does not go into effect until January 1, 2012. This information about well and plumbing work is current as of the date of publication. Recent legislation, rules, and the DLI should be consulted.

*D. limited licensure to seal wells or borings, remove obstructions from a well or boring before sealing, remove or perforate casing before sealing, or other activities to seal a well or boring, except that a drive point well or dug well contractor may seal a dug well or drive-point well, a dewatering well contractor may seal a dewatering well, an elevator boring contractor may seal an elevator boring, a vertical heat exchanger contractor may seal a vertical heat exchanger, and a monitoring well contractor may seal a monitoring well or environmental bore hole;*

*E. limited licensure to construct, repair, seal, or modify as specified in subpart 1, item F, a dewatering well; or*

*F. limited licensure to construct, repair, seal, or modify as specified in subpart 1, item F, a vertical heat exchanger.*

***Subp. 5. Elevator boring contractor license.*** *A person must have an elevator boring contractor's license or a well contractor's license to construct, repair, or seal an elevator boring.*

An elevator boring is a bore hole, jack hole, drilled hole, or excavation constructed to install a hydraulic cylinder for an elevator. It does not include cable elevators without a hydraulic cylinder, the chase the elevator car rides in, or hydraulic cylinders or lifts for other purposes such as automobile lifts at service stations. By definition, “holeless” or “limited-access” hydraulic elevators are also not regulated if the depth of the excavation including the pit and jack hole is less than 10 feet below the lowest landing of the elevator.

***Subp. 6. Monitoring well contractor registration.*** *A person must be either licensed as a well contractor or registered as a monitoring well contractor to:*

*A. construct, repair, modify, or seal monitoring wells or environmental bore holes; or*

*B. install pumps in monitoring wells.*

*A person with a limited license to install a well pump or pumping equipment may install pumps in monitoring wells.*

***Subp. 7. Individual well contractor license.*** *A person who is licensed as an individual well contractor must meet the requirements for licensure for a well contractor, except the requirements for a bond as specified in part 4725.1250.*

A person licensed as an individual well contractor must annually renew the license and obtain continuing education but is not required to carry a bond. This “I” license is obtained by persons who want to “back up” a certified representative in the company in case the person leaves or is incapable of representing the company, for future conversion to represent a licensee, or sometimes for retired persons who wish to maintain credentials. Conversion from an “I” to a representative can be done simply by completing an application. An individual well contractor may not perform well contracting work.

A table summarizing the certification and license requirements plus a step-by-step summary of the licensing process is located after Minnesota Rules, part 4725.1800.

*STAT AUTH: MS s 103I.101; 103I.111; 103I.205; 103I.221; 103I.301; 103I.401; 103I.451; 103I.501; 103I.525; 103I.531; 103I.535; 103I.541; 103I.621; 144.05; 144.12; 144.383; 157.04; 157.08; 157.09; 157.13*  
*HIST: 17 SR 2773; 25 SR 1207; 33 SR 211*

**4725.0500** [Repealed, 17 SR 2773]

**4725.0550 CERTIFIED REPRESENTATIVE OR INDIVIDUAL WELL CONTRACTOR.**

*Subpart 1. Qualification application for certification to represent a licensee, registrant, or to be an individual well contractor. Anyone applying to be certified as a representative of a licensee or registrant, or an individual well contractor, must submit to the commissioner a properly completed qualification application. The applicant must submit written documentation of the experience required in part 4725.0650. Written documentation includes, but is not limited to, well or boring construction or sealing records, letters from employers verifying employment, and work reports.*

This is a “**qualification**” application for a person (applicant) who wishes to be certified to represent a well contractor (licensee) or monitoring well contractor (registrant), or to become an individual well contractor. The “applicant” for certification is a human being. The licensee or registrant is a business entity such as partnership, corporation or other business. If the applicant pays the qualification fee, meets the minimum qualification requirements, and passes the exam, the person becomes certified. If the person wishes to become an individual well contractor, an individual license application is then filled out, and a fee submitted. If the person wants to represent a well contractor (licensee) or monitoring well contractor (registrant), the certified representative’s name must be included on the license or registration application or renewal for the contractor.

A certification/licensing summary is located after Minnesota Rules, part 4725.0800.

Each licensed or registered firm must have at least one certified representative, but may have more than one.

At this time, there is no fee to renew the certification of the representative. There is a fee to renew the license or registration of the contracting firm (licensee or registrant), or to renew an individual well contractor license.

*Subp. 2. [Repealed, 18 SR 1222]*



**Subp. 3. Qualifications, responsibilities, requirements.** A certified representative and individual well contractor must have honesty and integrity.

A. The certified representatives, or the individual well contractor, must be named on the license or registration for the licensee or registrant.

B. A certified representative must not represent more than one licensee or registrant.

If the licensee is a company or business, the licensee (company) must have at least one certified representative (human being who meets the qualification requirements). The individual license only relates to the “well contractor” license, not the limited or other licenses.

C. The certified representative must:

(1) supervise work to assure compliance with this chapter;  
(2) complete and sign permit applications, notifications, variance applications, construction records, and sealing records; and

(3) be responsible for conducting all operations under the representative's supervision and as delegated by the licensee or registrant according to this chapter and Minnesota Statutes, chapter 103I.

The certified representative who signs the permit or notification is responsible for the well or boring.

If a well or boring is **subcontracted** from a licensed or registered contractor to another licensed or registered contractor, the contractor who filed the notification or permit is responsible to the MDH for the well or boring including, submission of records, samples, and compliance with the law and rules.

**D. The certified representative and individual well contractor must annually complete the continuing education requirements in part 4725.1650.**

All certified representatives and individual well contractors must obtain two hours of MDH-provided or MDH-sponsored continuing education each year to maintain certification. Certified representatives of well contractors and monitoring well contractors must obtain an additional four hours of continuing education meeting the criteria established in these rules (Minnesota Rules, part 4725.1675).

If a licensee or registrant (company) has more than one certified representative, each representative must complete the continuing education requirements if they wish to maintain their certification and continue to represent the licensee or registrant.

**Subp. 4. Loss of certified representative.** When a certified representative no longer works for the registrant or licensee, the registrant or licensee must inform the commissioner within five days of that fact. If a licensee or registrant has only one certified representative and the representative no longer works for the registrant or licensee, the registrant or licensee must name an acting representative until a representative who meets the requirements in parts 4725.0550 to 4725.1025 is certified by the commissioner. The licensee or

*registrant may operate with an acting representative for no more than 150 days. The acting representative must notify the commissioner during business hours, a minimum of 24 hours prior to commencing work, of the proposed starting time of each well or boring construction or sealing.*

A certified representative may leave a licensee or registrant through retirement, change of job, or death. There are no minimum qualifications or exam requirements for a person to serve as an acting representative. Because the acting representative may have little experience, the rule requires the acting representative to notify the MDH prior to performing work so that an inspector may be present.

*STAT AUTH: MS s 103I.101; 103I.111; 103I.205; 103I.221; 103I.301; 103I.401; 103I.451, 103I.501; 103I.525; 103I.531; 103I.535; 103I.541; 103I.621; 144.05; 144.12; 144.383; 157.04; 157.08; 157.09; 157.13  
HIST: 17 SR 2773; 18 SR 1222; 33 SR 211*

**4725.0600 [Repealed, 15 SR 78]**

### **4725.0650 EXPERIENCE REQUIREMENTS, CERTIFIED REPRESENTATIVE AND INDIVIDUAL WELL CONTRACTOR.**

The experience requirements, license/registration process, and license/registration types are summarized after Minnesota Rules, part 4725.1800.

The term “under the supervision of a licensed contractor” means that the applicant gained experience under a contractor who is (or was) licensed or registered in Minnesota to construct the type of well or boring that the applicant is applying for a license or registration to construct.

*Subpart 1. Well contractor certified representative and individual well contractor. Anyone applying to be certified as a representative of a well contractor or to be an individual well contractor must have four years of experience. A year of experience is a year in which the applicant personally, and under the supervision of a licensed well contractor:*

A year of experience is a calendar year.

In order to qualify, the applicant must have **personally constructed** water-supply wells, sealed water-supply wells, and installed pumps in water-supply wells. Supervision does not qualify. The applicant must have personally constructed at least ten water-supply wells each year, in four different years, operating the drilling machine and directing the construction of the well. The applicant must be able to document the work. The MDH will review well records, ask for references and verification, and conduct inspection of wells reported as drilled. A “licensed well contractor” refers to a (full) well contractor licensed by the MDH.

Experience in the state of Minnesota prior to January 1, 1973, which was not under the supervision of a licensed contractor may apply if the experience can be documented. Experience outside the state may qualify if the experience is comparable to Minnesota (subpart 9) and the experience can be documented.

The MDH will contact the other state(s) to verify experience, licensing, and compliance. Well education gained at a technical/vocational or other school may qualify (as detailed below). The applicant should contact the MDH.

*A. worked for a minimum of 1,000 hours. The applicant's 1,000 hours of experience must include drilling water-supply wells, grouting, sealing wells, repairing wells, installing pumps, disinfecting wells, and completing well construction and sealing records; and*

*B. constructed a minimum of ten water-supply wells; or.*

*C. constructed at least one or more multiple cased water-supply wells with an outer casing diameter of ten inches or more and a well depth or cumulative depth of 700 feet or more.*

*An applicant with experience prior to 2006 must have constructed a minimum of five water-supply wells per year.*

In previous years, the rules required only five wells per year to qualify. This provision allows older experience to be "grandfathered."

*An applicant shall be deemed to have one year of experience if the applicant has successfully completed one year of education in well construction practices at an accredited college, university, or post-secondary institution. An applicant shall be deemed to have up to a maximum of two years of experience if the applicant has successfully completed an associate or technical degree in well construction practices at an accredited college, university, or post-secondary institution.*

A limited number of colleges offer education in well construction practices. Staples Technical College in Minnesota formerly provided a program, but no longer does so. Some current programs include: "Well Construction Technology," at Southwest Mississippi Community College, Summit, Mississippi; and "Resources Drilling and Blasting Technician," Fleming College School of Environmental and Natural Resource Sciences, Lindsay, Ontario, Canada.

*Supervision is not considered equivalent to personally doing the work.*

*Subp. 2. **Monitoring well contractor certified representative.** Anyone applying to be certified as a representative of a monitoring well contractor must meet the requirements in items A to C, or meet the requirements in item D.*

*A. The applicant must be:*

*(1) a professional engineer licensed by the Minnesota State Board of Architecture, Engineering, Land Surveying, Landscape Architecture, Geoscience, and Interior Design according to Minnesota Statutes, sections 326.02 to 326.15;*

A registered professional engineer (PE) in any discipline may qualify. Registration in another state is not an equivalent qualification.

*(2) a hydrologist or hydrogeologist certified by the American Institute of Hydrology; or*

*(3) a geologist certified by the American Institute of Professional Geologists, or a geoscientist licensed by the Minnesota State Board of Architecture, Engineering, Land Surveying, Landscape Architecture, Geoscience, and Interior Design under Minnesota Statutes, sections 326.02 to 326.15.*

The American Institute of Hydrology and the American Institute of Professional Geologists are private national organizations that establish minimum education and experience qualifications to “certify” hydrologists and geologists. These certifications are independent of geoscientist licensing in Minnesota. Registration as a geologist, hydrologist, or hydrogeologist in another state or by other organizations is not equivalent qualification. It should be noted that anyone providing Geoscience services as defined in Minnesota Statutes, section 326.02, must be licensed by the Minnesota State Board of Architecture, Engineering, Land Surveying, Landscape Architecture, Geoscience, and Interior Design.

*B. The applicant must have three years of experience. A year of experience is a year in which the applicant worked a minimum of 500 hours in construction, repair, and sealing of monitoring wells, or environmental bore holes including design, field supervision, or actual construction.*

*C. The applicant must have designed, field supervised, or actually constructed 50 monitoring wells or environmental bore holes.*

There are two options to qualify for certification to represent a monitoring well contractor. The method detailed in A through C above requires a professional accreditation and allows design or supervision of construction. The “hands-on” method of D below requires that the applicant personally has drilled monitoring wells.

*D. The applicant must have three years of experience in construction, repair, and sealing of monitoring wells and environmental bore holes. A year of experience is a year in which the applicant, personally and under the supervision of a registered monitoring well contractor or licensed well contractor, constructed a minimum of 20 monitoring wells or environmental bore holes, of which at least five must be monitoring wells, and constructed, sealed, and repaired monitoring wells or environmental bore holes for 1,000 hours.*

*Subp. 3. Limited well/boring contractor certified representative; drive point wells or dug wells. Anyone applying to be certified as a representative for a limited well/boring contractor licensed to construct, repair, and seal dug wells and drive-point wells must have three years of experience. A year of experience is a year in which the applicant personally constructed five dug wells or drive-point wells and worked for a minimum of 1,000 hours constructing, repairing, or sealing dug wells*

*or drive-point wells and installing pumps in dug wells or drive-point wells. An applicant must have gained the experience under a licensed well contractor or a licensed drive-point well or dug well contractor.*

Any combination of dug and/or drive-point water-supply well experience can qualify. Wells installed for monitoring or dewatering do not qualify.

**Subp. 4. Limited well/boring contractor certified representative; well screens, pitless adapters, and pitless units.** *Anyone applying to be certified as a representative for a limited well/boring contractor licensed to install or repair well screens or pitless adapters or units and well casing from the pitless device to the upper termination of the well must have two years of experience. A year of experience is a year in which the applicant worked a minimum of 1,000 hours and personally installed or repaired five well screens or pitless units or adapters and well casings from the pitless unit or adapter to the upper termination of the well. The experience must have been gained under the supervision of a licensed well contractor or limited well/boring contractor licensed to install or repair well screens or pitless units or adapters and well casings from the pitless unit or adapter to the upper termination of the well.*

**Subp. 5. Limited well/boring contractor certified representative; pumps and pumping equipment.** *Anyone applying to be certified as a representative for a limited well/boring contractor licensed to install a pump or pumping equipment must have two years of experience in pump installation and repair. The applicant must have personally installed 20 pumps. The work must include a minimum of 1,000 hours installing well pumps or pumping equipment.*

**Subp. 6. Limited well/boring contractor certified representative; well sealing.** *Anyone applying to be certified as a representative for a limited well/boring contractor licensed to seal wells must have three years of experience. A year of experience is a year in which the applicant:*

- A. personally sealed a minimum of five wells; and*
- B. worked a minimum of 1,000 hours constructing wells, clearing obstructions, removing or perforating well casings, and grouting wells.*

*The applicant must have gained the experience under a licensed well contractor or limited well/boring sealing contractor.*

Borings, including environmental bore holes, elevator borings, and vertical heat exchangers may also be sealed with this license.

**Subp. 7. Limited well/boring contractor certified representative; dewatering wells.** Anyone applying to be certified as a representative for a limited well/boring contractor licensed to construct, repair, or seal dewatering wells must have two years of experience. A year of experience is a year in which the applicant:

A. worked a minimum of 500 hours designing, constructing, or field supervising the construction, repair, or sealing of dewatering wells; and

B. designed, constructed, or field supervised the construction of a minimum of five dewatering wells.

The experience does not have to be gained under a licensed contractor.

**Subp. 7a. Limited well/boring contractor certified representative; vertical heat exchanger.** Anyone applying to be certified as a representative for a limited well/boring contractor licensed to construct, repair, or seal vertical heat exchangers must meet the requirements in item A or meet the requirements in items B and C.

A. The applicant must have two years of experience. A year of experience is a year in which the applicant personally, and under the supervision of a licensed well contractor or licensed vertical heat exchanger contractor, constructed a minimum of three separate permitted vertical heat exchanger systems, with a minimum total footage of 2,000 feet of vertical heat exchanger, and worked a minimum of 500 hours designing, constructing, or field supervising the construction, repair, or sealing of vertical heat exchangers.

B. The applicant must have a minimum of two years experience in well drilling. A year of experience is a year in which the applicant personally and under the supervision of a licensed well contractor constructed a minimum of five water-supply wells and constructed, repaired, or sealed wells and environmental bore holes for 500 hours.

C. The applicant must be certified by the International Ground Source Heat Pump Association or have an equivalent certification, as determined by the commissioner, based on number of hours of training, subject material, and testing.

Similar to monitoring well contractors, there are two different types of experience that can be considered in order to qualify as a certified representative of a vertical heat exchanger contractor. The first type is for the applicant to have direct, “hands-on” experience drilling vertical heat exchangers. The second type is for applicants who may have well drilling experience, and are certified by International Ground Source Heat Pump Association (IGSPHA) as an installer, but may have no experience drilling vertical heat exchangers. The IGSPHA is a national certification body.

**Subp. 8. Elevator boring contractor certified representative.** Anyone applying to be certified as a representative for an elevator boring contractor licensed to construct, repair, or seal an elevator boring must have two years of experience

*related to the construction, repair, and sealing of elevator borings. A year of experience is a year in which the applicant designed, supervised, or actually constructed three elevator borings.*

*Subp. 9. **Experience outside state.** If all or part of the experience required in this part was gained by an applicant outside Minnesota, the applicant must provide the commissioner with information satisfactorily demonstrating that the experience was gained constructing, repairing, and sealing wells or borings in geological conditions substantially similar to conditions in Minnesota and in a jurisdiction with certification, licensing, or registration requirements comparable to those in Minnesota.*

There is no direct reciprocity with other states. A person must meet the minimum qualifications, pass the exam, complete the necessary forms, and submit the fees.

*STAT AUTH: MS s 103I.101; 103I.111; 103I.205; 103I.221; 103I.301; 103I.401; 103I.451; 103I.501; 103I.525; 103I.535; 103I.541; 103I.621; 144.05; 144.12; 144.383; 157.04; 157.08; 157.09; 157.13*

*HIST: 17 SR 2773; L 1992 c 507s 2; 25 SR 1207; 33 SR 211*

**4725.0700** [Repealed, 17 SR 2773]

**4725.0800** [Repealed, 15 SR 78]

**4725.0900 COUNCIL EVALUATION OF APPLICANTS.**

The “council” refers to the Advisory Council on Wells and Borings.

*Upon request by the commissioner, the council may conduct oral examinations using a standardized examination developed by the commissioner in consultation with the council. Upon request by the commissioner, the council may also provide recommendations as to the appropriate disciplinary action for representatives, licensees, and registrants found to be in violation of Minnesota Statutes, chapter 103I and this chapter.*

The well contractor certified representative and individual well contractor applicants must pass an oral examination before the advisory council in addition to a written exam. Other applicants must only pass a written examination.

*STAT AUTH: MS s 103I.101; 103I.111; 103I.205; 103I.221; 103I.301; 103I.401; 103I.451; 103I.501; 103I.525; 103I.531; 103I.535; 103I.541; 103I.621; 156A.01 to 156A.08*

*HIST: 15 SR 78; 33 SR 211*

**4725.1000 [Repealed, 17 SR 2773]**

**4725.1025 EXAMINATION.**

*Anyone applying to be a certified representative of a licensee or registrant or as an individual well contractor must pass an examination which may be a combination of written and oral questions as determined by the commissioner with the advice of the Advisory Council on Wells and Borings established by Minnesota Statutes, section 103I.105. The applicant must pass the examination within one year from the date notified by the commissioner that the applicant is qualified to take the examination. An applicant who fails an examination must not retake the examination within two weeks of the failed attempt. An applicant who fails to successfully complete the examination after three attempts, must reapply for certification as a representative, or licensure as an individual well contractor, according to parts 4725.0550 to 4725.1025, and must not reapply within one year of the third failure to pass the examination. If, upon passing the examination, the applicant is not licensed as an individual well contractor or listed as a certified representative of a licensee or registrant within one year, reapplication as a certified representative or individual well contractor must be made according to parts 4725.0550 to 4725.1025.*

*STAT AUTH: MS s 103I.101; 103I.111; 103I.205; 103I.221; 103I.301; 103I.401; 103I.451; 103I.501; 103I.525; 103I.531; 103I.535; 103I.621; 144.05; 144.12; 144.383; 157.04; 157.08; 157.09; 157.13*

*HIST: 17 SR 2773; 33 SR 211*

The examinations are related to the specific license or registration, and primarily cover the requirements of the rules and law, and some background information. The examination is largely not a test of skills or knowledge of drilling practices.

If the applicant passes the exam but doesn't complete the licensing or registration process within **one year**, the applicant must start at the beginning and reapply by submitting the qualification application and fee with documentation of required experience, and successfully pass the exam again.

**4725.1050 [Repealed, 17 SR 2773]**

**4725.1075 APPLICATION FOR LICENSURE OR REGISTRATION.**

*Subpart 1. Application for licensure or registration. A person must apply for licensure or registration on a form provided by the commissioner.*

*A. The application must include the name, address, and telephone number of the person applying for licensure or registration and list the name, business address, and telephone number, if different, of all certified representatives of the*



*licensee or registrant who meet the qualifications in parts 4725.0550 to 4725.1025. The licensee or registrant must have at least one certified representative.*

The “person” referred to here is generally a business, in which case the name is the corporation or business name, not the name of the certified representative. Individual well contractors should not be listed on the application.

*B. The application form must be signed by an officer or other legally authorized agent of the person making application for licensure or registration.*

The “person” is again typically a business. The officer does not necessarily have to be the certified representative, but must be legally responsible for the company.

*C. The application for licensure or registration must be accompanied by the nonrefundable licensure or registration fee specified in Minnesota Statutes, chapter 103I.*

The license and registration fee types are listed in Minnesota Rules, part 4725.0350 and the amounts summarized in the table after Minnesota Rules, part 4725.1800. The license or registration fee is in addition to the (qualification) application fee.

*Subp. 2. [Repealed, 18 SR 1222]*

*STAT AUTH: MS s 103I.101; 103I.111; 103I.205; 103I.221; 103I.301; 103I.401; 103I.451; 103I.501; 103I.525; 103I.531; 103I.535; 103I.541; 103I.621; 144.05; 144.12; 144.383; 157.04; 157.08; 157.09; 157.13  
HIST: 17 SR 2773; 18 SR 1222; 33 SR 211*

**4725.1100 [Repealed, 15 SR 78]**

**4725.1200 [Repealed, 15 SR 78]**

**4725.1250 BONDING.**

*At the time the fee is submitted for initial licensure or registration, or licensure or registration renewal, the licensee or registrant must show proof of holding a corporate surety bond as required by Minnesota Statutes, chapter 103I. The bond must be submitted to the commissioner. One bond is required for each licensee or registrant. If on proof to the commissioner it is shown that multiple licenses or registrations are held by one licensee or registrant, the bond held by that licensee or registrant may cover all licenses and registrations. The licensee or registrant must be named as the principal. The bond must be signed by an official of the company who is legally authorized to represent the company. The bond may be*

*used by the commissioner to compensate persons injured or suffering financial loss because of failure of a licensee or registrant to properly perform the duties under part 4725.0475 and Minnesota Statutes, chapter 103I. The term of the bond must be continuous or concurrent with the term of the license or registration. The penal sum of the bond is noncumulative and is not to be aggregated every year that the bond is in force. The bond must be written by a corporate surety licensed to do business in Minnesota. The corporate surety shall be responsible for providing 30 days' written notice to the commissioner of cancellation of a licensee's or registrant's bond. If a bond is canceled, a licensee or registrant must not perform work requiring the license or registration until the licensee or registrant obtains another bond meeting the requirements of this part. An individual well contractor, as described in Minnesota Statutes, section 103I.525, subdivision 1, paragraph (c), is exempt from the requirements of this part.*

The bond is sometimes referred to as a “license” bond, or a “license bond with performance guarantees.” The bond is in lieu of other license bonds required by a political subdivision of the state. A general contractor’s bond, performance bond, plumbing bond, or bond for a subsurface sewage treatment system contractor does not take the place of a well or boring contractor bond.

The commissioner of health may use the bond to pay for unlawful performance of work regulated by Minnesota Statutes, Chapter 103I or Minnesota Rules, Chapter 4725. Proceeds of the bond may be used to compensate persons injured or suffering financial loss because of a failure of a licensee or registrant to properly perform work.

The bond is not an insurance policy; it is an agreement to pay up to the amount of the bond (\$25,000, \$10,000, or \$2,000 for some of the limited licenses). The bonding or “surety” company guarantees that the money will be paid and holds the “principal” (the licensee or registrant) responsible for payment, and will attempt to collect from the principal by attachment of assets if necessary.

The bond must be in effect during the license period. The bond total (penal sum) will not exceed \$25,000, \$10,000, or \$2,000 depending on the license type. The bond remains in effect for the period that it was issued for, even if the bond is not renewed. In other words, if a contractor is bonded and then retires, and a violation is later found that occurred during the period that the bond was in effect, the bond may be activated to make a correction. The surety company will seek payment from the contractor.

*STAT AUTH: MS s 103I.101; 103I.221; 103I.301; 103I.621; 144.05; 144.12; 144.122; 144.383; 157.04; 157.08; 157.09; 157.13  
HIST: 15 SR 78; 17 SR 2773; 18 SR 1222*

#### **4725.1300 LICENSE OR REGISTRATION RENEWAL.**

*Subpart 1. **Renewal.** Licenses expire on January 31 of each year and registrations expire on December 31 of each year. Each licensee or registrant shall submit an application for license or registration renewal on forms provided*

*by the commissioner no later than January 31 for licenses and December 31 for registrations. The renewal application must be accompanied by the license and registration fees. A penalty fee, as specified in Minnesota Statutes, chapter 103I, must also be paid if the renewal is submitted after the January 31 license or December 31 registration deadline. At the time of license or registration renewal, the approved continuing education courses completed by the individual well contractor as required by part 4725.1650, or the name(s) of the certified representative(s), must be listed, and the licensee or registrant must provide the bond required under part 4725.1250.*

Monitoring well contractors are registered. All other categories are licensed. If the license or registration is not renewed, the contractor may **not** perform well or boring contracting work. The licensee or registrant must have all construction and sealing records and water sample results submitted, or a license or registration will not be renewed. At least one certified representative must have completed the appropriate continuing education in order to renew the license or registration. Only certified representatives who have completed the continuing education may represent the company for such matters as obtaining permits, filing notifications, and other activities.

The late license or registration renewal fee is \$75 in addition to the renewal fee.

***Subp. 2. Failure to renew.** A licensee or registrant who fails to renew a license or registration before the expiration date, and later wishes to renew, must pay all license or registration fees and late fees.*

*STAT AUTH: MS s 103I.101; 103I.111; 103I.205; 103I.221; 103I.301; 103I.401; 103I.451; 103I.501; 103I.525; 103I.531; 103I.535; 103I.621; 144.05; 144.12; 144.122; 144.383; 156A.01 to 156A.08; 157.04; 157.08; 157.09; 157.13*

*HIST: 15 SR 78; 17 SR 2773; 18 SR 1222; 33 SR 211*

#### **4725.1310 CERTIFICATION RENEWAL.**

***Subpart 1. Renewal.** Certification of licensee representatives expire on January 31 of each year and certification of registrant representatives expire on December 31 of each year. Each representative shall submit an application for certification renewal on forms provided by the commissioner no later than January 31 for licensee representatives, and December 31 for registrant representatives. At the time of certification renewal, the approved continuing education courses completed by the representative as required by part 4725.1650 must be listed.*

***Subpart 2. Failure to renew.** A person who fails to renew a certification within two years of expiration may not renew the certification. Requalification for certification must be according to parts 4725.0550 to 4725.1250.*

STAT AUTH: MS s 103I.101; 103I.111; 103I.205; 103I.221; 103I.301; 103I.401; 103I.451; 103I.501; 103I.525; 103I.531; 103I.535; 103I.541; 103I.621;  
HIST: 33 SR 211

**4725.1325** [Repealed, 17 SR 2773]

**4725.1350** [Repealed, 17 SR 2773]

**4725.1400** [Repealed, 17 SR 2773]

**4725.1500 DISCIPLINARY ACTION: RETURN OF DOCUMENTS.**

*Subpart 1. Commissioner action. The commissioner may suspend, revoke, or impose limitations or conditions on a license, certification, or registration if the certified representative, individual well contractor, registrant, or licensee:*

- A. violates a provision of this chapter or Minnesota Statutes, chapter 103I;*
- B. obtains a certification, license, or registration through error, fraud, or cheating;*
- C. provides false or fraudulent information verbally, or on renewal forms, construction or sealing reports, water sample reports, or other required reports;*
- D. knowingly aids or allows an unlicensed or unregistered person to engage in activities requiring a license or registration under Minnesota Statutes, section 103I.205, subdivision 4;*
- E. engages in conduct, in the course of performing work requiring licensure or registration, that is likely to harm the public, or conduct that demonstrates a willful or careless disregard for the health or safety of a property owner or other person;*
- F. has been convicted during the previous five years of a felony or gross misdemeanor reasonably related to the business of well or boring construction, repair, or sealing;*
- G. fails to pay monetary penalties that are assessed according to an Administrative Penalty Order issued under Minnesota Statutes, chapter 144; or*
- H. violates the conditions of a stipulated agreement, variance, order, settlement, compliance agreement, license, registration, certification, notification, or permit.*

*Subp. 2. [Repealed, 17 SR 2773]*

*Subp. 3. [Repealed, 17 SR 2773]*

**Subp. 4. Revoked certification, license, or registration.** A suspended or revoked certification, license, or registration along with the current drilling machine and hoist registration decals must be returned to the commissioner when the certification, license, or registration is revoked or suspended.

Enforcement actions for correction of rule or statute violations are the responsibility of the person who caused the violation, often the licensed or registered contractor. Enforcement actions for repair, construction, and sealing are explained in Minnesota Rules, part 4725.0250. This rule pertains only to license or certification actions against the company (licensee or registrant) or certified representative, and may include license or registration conditions, suspension, or revocation. While the action to require an improperly grouted well to be grouted will be taken against the licensee only, action to revoke or suspend the license and certification may be taken against both the licensee (company) and the certified representative if the violation is serious or repeated.

**STAT AUTH:** MS s 103I.101; 103I.111; 103I.205; 103I.221; 103I.301; 103I.401; 103I.451; 103I.501; 103I.525; 103I.531; 103I.535; 103I.541; 103I.621; 144.05; 144.12; 144.383; 156A.01 to 156A.08; 157.04; 157.08; 157.09; 157.13

**HIST:** 15 SR 78; 17 SR 2773; 33 SR 211

#### **4725.1600 REAPPLICATION AFTER CERTIFICATION, LICENSE, OR REGISTRATION REVOCATION.**

**Subpart 1. Revoked certification, license, or registration.** A person whose certification as a representative, license, or registration has been revoked may not reapply for certification, licensure, or registration within one year of the date of revocation. A person, whose certification, license, or registration has been revoked must reapply as required by parts 4725.0550 to 4725.1250.

The “person” may be the certified representative, individual well contractor, and/or the licensee or registrant (business). This provision effectively prohibits the person from doing regulated work for one year plus the time necessary to become recertified, reregistered, or relicensed. Relicensing, re-registration, or recertification is not automatic. At the minimum, the person must follow the same procedures as a new applicant. Minnesota Rules, part 4725.1500, subpart 1 allows the commissioner of health to suspend, revoke, or impose limitations or conditions on a license or registration. For example, a person may be granted a conditional license requiring 24-hour notification before drilling, or may be prohibited from doing certain types of activities.

**Subp. 2. [Repealed, 17 SR 2773]**

**Subp. 3. [Repealed, 17 SR 2773]**

**STAT AUTH:** MS s 103I.101; 103I.111; 103I.205; 103I.221; 103I.301; 103I.401; 103I.451; 103I.501; 103I.525; 103I.531; 103I.535; 103I.541; 103I.621; 144.05; 144.12; 144.383; 156A.01 to 156A.08; 157.04; 157.08; 157.09; 157.13

**HIST:** 15 SR 78; 17 SR 2773; 33 SR 211

## **4725.1650 CONTINUING EDUCATION REQUIREMENTS.**

Continuing education requirements apply to certified representatives of: well contractors, limited licensees (pump, pitless/screen, dug well/drive-point, dewatering, vertical heat exchanger, and sealing), elevator contractors, and monitoring well contractors; plus individual well contractors.

*An individual well contractor or certified representative of a well contractor or monitoring well contractor must successfully complete six contact hours of continuing education activities annually of which at least two hours must be obtained from a continuing education program presented or sponsored by the commissioner. A certified representative of a limited well/boring contractor or elevator boring contractor, must successfully complete two contact hours of continuing education annually presented or sponsored by the commissioner. A person with multiple limited well/boring or elevator boring certifications need only successfully complete two contact hours of continuing education annually presented or sponsored by the commissioner.*

Certified representatives of well contractors and monitoring well contractors must obtain a total of six contact hours of continuing education, including two hours of MDH-provided or MDH-sponsored continuing education. Certified representatives for all other license types must only obtain two hours of MDH-provided or MDH-sponsored continuing education. MDH-provided or MDH-sponsored programs may include MDH district meetings, MDH presentations at the Minnesota Water Well Association Convention & Trade Show, delegated well programs, manufacturer/supply house programs, and professional or educational conferences.

*An individual well contractor or certified representative is exempt from the continuing education requirements for one year following the completion of the examination in part 4725.1025.*

This provision applies to representatives certified for the first time. The certified representative does not need continuing education to renew the certification for the first time. For example, if the representative is originally certified in 2010, the representative does not need to obtain continuing education in 2010 in order to renew for 2011. The certified representative does need to obtain continuing education in 2011 in order to renew for 2012.

*An individual well contractor or certified representative who fails to complete the continuing education required by this part, must not conduct contracting, or represent a licensee or registrant, for activities regulated by this chapter.*

Continuing education contact hours cannot be “banked” or saved from previous years for future renewal. Contact hours must be accumulated within the license or registration year immediately prior to the license or registration year to be renewed.

- The registration year is January 1 to December 31.
- The license year is February 1 to January 31.

*STAT AUTH: MS s 103I.101; 103I.111; 103I.205; 103I.221; 103I.301; 103I.401; 103I.451; 103I.501; 103I.525; 103I.531; 103I.535; 103I.541; 103I.621; 144.05; 144.12; 144.383; 157.04; 157.08; 157.09; 157.13*

*HIST: 15 SR 78; 17 SR 2773; 33 SR 211*

#### **4725.1675 CRITERIA FOR CONTINUING EDUCATION.**

*A continuing education activity must meet the criteria in items A to E for credit to be given.*

*A. The activity must be related to wells and borings, drilling technology, groundwater contamination, health aspects of water quality, groundwater monitoring, geology, hydrology, well or boring construction and sealing, water systems and water treatment, or other subjects approved by the commissioner.*

*B. The activity must have a specific, written objective that describes expected outcomes for the participant.*

*C. The activity must be presented by a person knowledgeable about recent developments in the subject. The person's qualifications must be documented by either specialized training in the subject matter or work experience in the subject area.*

*D. The activity must be at least one contact hour as defined in part 4725.0100, subpart 24c.*

A “contact hour” means 50 minutes of instruction. A “contact hour” is not the same as a “CEU,” which is approximately ten hours of instruction.

*E. The activity must document participation, including but not limited to earned credits and verification of attendance. Program sponsors shall maintain attendance sheets for two years.*

Courses approved for credit are published in the Well Management News newsletter and listed on the MDH Well Management Section Web site continuing education calendar. Persons wishing to attend other courses for credit should contact the MDH prior to attendance. Courses must be approved by the MDH.

*STAT AUTH: MS s 103I.101; 103I.111; 103I.205; 103I.221; 103I.301; 103I.401; 103I.451; 103I.501; 103I.525; 103I.531; 103I.535; 103I.541; 103I.621;*

*HIST: 15 SR 78; 33 SR 211*

**4725.1685 ADVISORY COUNCIL REVIEW OF CONTINUING EDUCATION PROGRAMS.**

*The Advisory Council on Wells and Borings may review continuing education programs and make recommendations to the commissioner as to the acceptability for continuing education credits for each license or registration category.*

*STAT AUTH: MS s 103I.101  
HIST: 15 SR 78*

**4725.1700 PLACEMENT OF DECALS AND LICENSE OR REGISTRATION NUMBER.**

*A licensee or registrant shall place in a conspicuous location on both sides of each drilling machine or hoist the license or registration number in figures not less than three inches high and 1-1/2 inches wide. The figures must be in a contrasting color to the rest of the machine or hoist. Decals issued by the commissioner designating the year for which the license or registration was issued or renewed must be affixed directly adjacent to and below the license or registration number on each drilling machine or hoist. Contractors using small drilling machines or hoists shall attach their decals on a portable display to be shown at the well or boring site. The decals shall be issued by the commissioner upon licensure or registration and renewal.*

The decals (provided by the MDH) are printed with “Drilling Machine/Hoist Registration,” the year of registration, and include the MDH logo. Two decals must be affixed to each drilling machine or hoist – one decal on each side. Both stickers must be placed on the machine. The license or registration number (of the business) must also be placed on the equipment. If the drilling machine or hoist is sold, it is recommended that the decals and MDH license or registration number be removed.

Minnesota Rules, part 4725.0100, subpart 26b and subpart 30c contain the definitions of “drilling machine” and “hoist.”

*STAT AUTH: MS s 103I.101; 103I.111; 103I.205; 103I.221; 103I.301; 103I.401; 103I.451; 103I.501; 103I.525; 103I.531; 103I.535; 103I.541; 103I.621; 144.05; 144.12; 144.383; 156A.01 to 156A.08; 157.04; 157.08; 157.09; 157.13  
HIST: 15 SR 78; 17 SR 2773; 33 SR 211*

**4725.1800 DRILLING MACHINE AND HOIST REGISTRATION.**

*Upon licensure or registration, the licensee or registrant must register all drilling machines and hoists and pay a fee for each machine or hoist. Each time the licensee or registrant renews licensure or registration under part 4725.1300, the licensee or registrant must renew each drilling machine and hoist registration*



*and must pay a renewal fee for each drilling machine or hoist. Upon acquiring additional drilling machines or hoists after initial licensure or registration or after renewal of licensure or registration, the licensee or registrant must register the machine or hoist and pay the hoist or drilling machine registration fee. The drilling machine and hoist registrations are concurrent with the license or registration, are not prorated, and expire on January 31 of each year for licensees and December 31 of each year for registrants. Upon receipt of the required fee and information, a drilling machine or hoist registration card shall be issued for identification purposes for each drilling machine and hoist registered by the contractor. The card shall be carried on the drilling machine or hoist at all times where it may be inspected by the commissioner.*

**Hand tools** such as casing drivers or chain hoists, or equipment such as tripods or jacks need not be registered.

Water trucks, trailers, flatbed pipe trucks, and other vehicles which are not used to drill a well or boring or are not used as a hoist for well or boring work may not be registered.

Minnesota Statutes, Chapter 168, contains language that exempts hoists and water well drilling equipment registered with the MDH from having state motor vehicle license plates. The law does place limitations on use of the vehicles as “special mobile equipment” not designed or used primarily for the transportation of persons or property. If a vehicle travels out of state or carries persons for transport, state license plates may be required. In 2001, state law was changed to allow contractors to carry materials related to the operation and use of drilling machines and hoists with that equipment. Previously, carrying any articles of commerce was prohibited, unless the truck was registered with the DPS. Contractors should contact the DPS or the Minnesota State Patrol – Commercial Vehicle Enforcement Section, for further information.

Operators of cranes with lifting capacities of 5 tons or more must be certified by the DLI under Minnesota Statutes, section 182.6525. The DLI has determined that drilling machines (drilling derricks) and most pump hoists are not considered cranes unless they are attached to mobile or locomotive cranes and are operated on construction sites. Questions about whether a well drilling mast or derrick is considered a “crane” for purposes of this law should be directed to the DLI.

*The registration card and decals furnished for a drilling machine or hoist are not transferable.*

The fee for registration of a drilling machine or hoist is not prorated. The total fee applies, regardless of when in the course of the year the equipment is registered. The registration of a drilling machine or hoist expires on the same date as the registration (December 31) or license (January 31) expiration. Likewise, there are no partial refunds if a registration is cancelled part-way through the year.

The MDH recommends that the decals be removed at the time a drilling machine or hoist is sold.

*A person must not use a drilling machine or hoist to conduct activities requiring a license or registration under this chapter unless the drilling machine or hoist is registered, displays the licensee's or registrant's license or registration number, and displays current decals.*

*STAT AUTH: MS s 103I.101; 103I.111; 103I.205; 103I.221; 103I.301; 103I.401; 103I.451; 103I.501; 103I.525; 103I.531; 103I.535; 103I.541; 103I.621; 144.122; 156A.01 to 156A.08*

*HIST: 15 SR 78; 18 SR 1222; 33 SR 211*

**SUMMARY OF CERTIFICATION/LICENSING  
QUALIFICATION REQUIREMENTS**

<b><u>CERTIFICATION, LICENSE, REGISTRATION</u></b>	<b><u>YEARS</u></b>	<b><u>HOURS</u></b>	<b><u>WELLS/BORINGS</u></b>	<b><u>BOND</u></b>
Well Constructor	4	1000/YR	10/YR <sup>1</sup> or 700 FT <sup>2</sup>	\$25,000
Individual Well Contractor	4	1000/YR	10/YR <sup>1</sup> or 700 FT <sup>2</sup>	NONE
Monitoring Well Contractor				
Engineer or Geologist	3	500/YR	50 TOTAL	\$10,000
Drilling Experience	3	1000/YR	20/YR	\$10,000
Limited Well Contractor				
Drive-point/Dug Well	3	1000/YR	5/YR	\$10,000
Screen, Pitless	2	1000/YR	5/YR	\$2,000
Pump	2	1000 TOTAL	20 TOTAL	\$2,000
Well Sealing	3	1000/YR	5/YR	\$10,000
Dewatering	2	500/YR	5/YR	\$10,000
Vertical Heat Exchanger				
Drilling Experience	2	500/YR	3 with 2,000 feet	\$10,000
Well and IGSHPA	2	500/YR	5/YR	\$10,000
Elevator Boring Contractor	2	NONE	3/YR	\$10,000

<sup>1</sup> Ten wells per year are needed for experience in years 2006 and later. Five wells per year is the minimum experience needed in years before 2006.

<sup>2</sup> In order to qualify for the 700-foot criteria, the applicant must have constructed one or more multiple-cased wells with an outer casing of 10-inch diameter or larger, with a cumulative depth of 700 feet or more.

## **APPLICATION PROCEDURE FOR CERTIFICATION AND LICENSURE OR REGISTRATION**

- STEP 1. QUALIFICATION APPLICATION. Submit completed application to apply for certification as a representative or licensure as an individual well contractor, which includes the following information:
- Written documentation of experience including:
    - Years of work related experience,
    - Hours per year of work related experience, and
    - Records of wells/borings/sealings, etc.
  - Three letters from individuals familiar with the applicants work (MDH or delegated local government well program staff should not be used for references) verifying experience and employment, and work reports; and
  - Nonrefundable application fee.
- STEP 2. DEPARTMENT REVIEW OF DOCUMENTATION. MDH reviews application, contacts references, and verifies experience. MDH inspects referenced wells and contacts well owners for individual well contractor applicants and applicants for well contractor representative certification. Applicants are informed of missing information, construction violations, errors and omissions.
- STEP 3. NOTICE OF ELIGIBILITY. MDH mails notice that the applicant qualifies or does not qualify for the exam. Exam preparation materials are mailed to qualified persons.
- STEP 4. WRITTEN EXAMINATION. The written exam is specific to each certification or license. The exams cover requirements of the law (Chapter 103I) and the rules (Chapter 4725) and technical and practical information related to the type of activity. Applicants for multiple certifications must take each exam. Written examinations can be taken in any of the district offices and are scheduled at a mutually agreeable time.
- STEP 5. ORAL EXAMINATION. Applicants for the well contractor representative certification and individual well contractor license must appear before the Advisory Council on Wells and Borings for an oral exam in addition to the written exam. The advisory council only meets four times a year, typically in March, June, September, and December. Other licenses and registrations do not require an oral exam.
- STEP 6. NOTICE OF EXAM RESULTS. Results are mailed within approximately two weeks of taking the exam. Failed written exams can be retaken by rescheduling with the district office; however, a two-week wait is required before retaking the exam.
- STEP 7. LICENSE OR REGISTRATION APPLICATION. The application must be completed within one year of passing the examination. Upon certification of a representative or upon a person who wants an individual well contractor license passing the oral examination, a completed application for license or registration may be submitted which includes the following:
- Applicant's name, address, telephone number (this is the licensee's name, typically a business);
  - Applicant's business name, address, telephone number (if different);
  - Legal signature of applicant or legally authorized representative of the applicant;
  - Name of all certified representatives;

- Proof of holding a corporate surety bond appropriate to the license or registration;
- Registration of drilling and hoisting equipment and equipment registration fee;
- License or registration fee appropriate to the license category; and
- Evidence of worker's compensation insurance, and tax identification information (which is forwarded to the Minnesota Department of Revenue).

STEP 8. LICENSE OR REGISTRATION MAILED. MDH mails license certificate and rig registration materials. Blank permit application forms and Well & Boring Record forms are also sent, depending on the request in the license or registration application.

The application must be completed within one year of completing all qualifications and examinations.

## **CERTIFICATION, LICENSING AND REGISTRATION SUMMARY**

(Note: Fees are current as of the printing of the handbook; check Minnesota Statutes, Chapter 103I, for amendments.)

**WELL CONTRACTOR.** An applicant to be certified to represent a well contractor must have four years of experience. A year of experience is a year in which the applicant personally drilled at least ten wells and worked at least 1000 hours drilling, sealing, and installing pumps in wells. Experience of five well per year may qualify for years prior to 2006. Applicants may qualify if the experience was gained in constructing one or more multiple-cased wells with a well depth or cumulative depth of more than 700 feet and with an outer casing diameter of 10 inches or more.

A well contractor may construct, repair, install pumps in, attach water conditioning or other devices to, chemically treat, develop, and seal, wells including: water-supply wells, dewatering wells, drive-point wells, dug wells, monitoring wells, and groundwater thermal exchange devices, and borings including: environmental bore holes, elevator boring excavations, and vertical heat exchangers. The license fee is \$250 plus a (temporary) \$25 surcharge. The surcharge is forwarded to the Minnesota electronic licensing system. A \$25,000 bond is required.

**INDIVIDUAL WELL CONTRACTOR.** The experience requirements are the same as for the well contractor. The individual does not represent a company and does not register drilling machines. Typically, persons obtain this license to have a “back-up” license in case the certified representative leaves the company. The individual is exempt from the bond requirement. The license fee is \$75 plus a \$7.50 surcharge. A bond is not required.

**MONITORING WELL CONTRACTOR.** An applicant to be certified to represent a monitoring well contractor must have three years of drilling experience or be a licensed professional engineer or geoscientist, or a certified geologist, hydrologist, or hydrogeologist and must have three years of experience. A year of experience is a year in which the applicant worked a minimum of 500 hours designing, field supervising, or personally constructing monitoring wells or environmental bore holes. The applicant must have designed, supervised, or constructed at least 50 monitoring wells or environmental bore holes. Applicants without professional registration may qualify if they have three years experience. A year of experience is a year in which the applicant personally constructed at least five monitoring wells and an additional 15 monitoring wells or environmental bore holes and worked a minimum of 1,000 hours constructing, repairing, or sealing monitoring wells or environmental bore holes.

A monitoring well contractor may construct, repair, install pumps in, attach water conditioning or other devices to, chemically treat, develop, and seal monitoring wells, and environmental bore holes. The registration fee is \$75 plus a \$7.50 surcharge. A \$10,000 bond is required.

**LIMITED DUG WELL AND DRIVE-POINT WELL CONTRACTOR.** An applicant to represent a limited dug well and drive-point well contractor must have three years of experience. A year of experience is a year in which the applicant personally installed at least five drive-points or dug wells and worked at least 1000 hours constructing, repairing, sealing, and installing pumps on drive-points and dug wells.

A drive-point and dug well contractor may construct, repair, install pumps in, attach water conditioning or other devices to, chemically treat, develop, and seal dug wells and drive-point wells. The license fee is \$75 plus a \$7.50 surcharge. A \$10,000 bond is required

**LIMITED WELL SCREEN AND PITLESS CONTRACTOR.** An applicant to represent a limited well screen and pitless contractor must have two years of experience. A year of experience is a year in which the applicant personally installed or repaired five well screens, pitless units or adapters, or well casings above the pitless, and worked a minimum of 1000 hours.

A limited well screen or pitless contractor may install or repair well screens, pitless units or adapters, and casings above the pitless. The license fee is \$75 plus a \$7.50 surcharge. A \$2,000 bond is required.

**LIMITED PUMP CONTRACTOR.** An applicant to represent a limited pump contractor must have two years of experience. The applicant must have personally installed 20 pumps and worked a minimum of 1000 hours installing well pumps and pumping equipment.

A limited pump contractor may install or repair well pumps or pumping equipment, and attach water conditioning or other devices to, chemically treat, or develop wells. The experience does not have to be gained under a licensed contractor. The license fee is \$75 plus a \$7.50 surcharge. A \$2,000 bond is required.

**LIMITED WELL SEALING CONTRACTOR.** An applicant to represent a limited well sealing contractor must have three years of experience. A year of experience is a year in which the applicant personally sealed a minimum of five wells and worked a minimum of 1000 hours clearing obstructions, removing or perforating casing, and grouting wells.

A limited well sealing contractor may remove obstructions in wells prior to sealing, remove or perforate casings, and seal wells. The license fee is \$75 plus a \$750 surcharge. A \$10,000 bond is required.

**LIMITED DEWATERING WELL CONTRACTOR.** An applicant to represent a limited dewatering well contractor must have two years of experience. A year of experience is a year in which the applicant designed, field supervised, or personally drilled five dewatering wells and worked a minimum of 500 hours designing, constructing, or field supervising the construction of dewatering wells.

A limited dewatering well contractor may construct, repair, install pumps in, attach water conditioning or other devices to, chemically treat, develop, and seal dewatering wells. The experience does not have to be gained under a licensed well contractor. The license fee is \$75 plus a \$7.50 surcharge. A \$10,000 bond is required.

**LIMITED VERTICAL HEAT EXCHANGER CONTRACTOR.** An applicant to represent a vertical heat exchanger contractor must have two years of experience. A year of experience is a year in which the applicant personally drilled a minimum of three permitted vertical heat exchanger systems (minimum total footage of 2000 feet) and worked a minimum of 500 hours designing, constructing, and field supervising the construction, repair, and sealing of vertical heat exchangers. The experience must be obtained under the supervision of a licensed well contractor or licensed vertical heat exchanger contractor. A second option is for the applicant to have two years of well drilling experience, where a year of experience is having drilled at least five water-supply wells and constructed, repaired, or sealed wells or environmental bore holes for 500 hours, and to be certified by the IGSHPA as a certified installer.

A limited vertical heat exchanger contractor may construct and seal vertical heat exchangers. The license fee is \$75 plus a \$7.50 surcharge. A \$10,000 bond is required.

**ELEVATOR BORING CONTRACTOR.** An applicant to represent an elevator boring contractor must have two years of experience and must have designed, supervised, or constructed three borings for the installation of elevator hydraulic cylinders.

An elevator boring contractor may construct, repair, or seal an elevator boring. The license fee is \$75 plus a \$7.50 surcharge. A \$10,000 bond is required.



**End  
of  
Licensing, Registration, Certification Section**

## **PERMITS AND NOTIFICATIONS**

### **4725.1810 PERMITS AND NOTIFICATIONS, GENERAL.**

*Subpart 1. Well on property of another.* A person must not construct, or have constructed, a well on another person's property unless a written agreement exists according to Minnesota Statutes, section 103I.205, subdivision 8. The well owner, or other person identified in the agreement as being responsible for the well, has the responsibilities, authorities, and obligations of the property owner specified in this chapter.

*Subp. 2. Delegated programs.* A person constructing or sealing a well or boring that is located within a political subdivision with a well and boring program delegated under Minnesota Statutes, chapter 103I, must file a notification with, or obtain a permit from, the delegated program prior to construction or sealing of a well or boring regulated by the delegated program, except that a notification for construction or sealing of a community public water-supply well must be filed with the commissioner.

The portion of the law pertaining to delegated well programs is Minnesota Statutes, section 103I.111.

*Subp. 3. Fees.* Notification and permit fees must be paid in according to parts 4725.0350 and 4725.1836 and Minnesota Statutes, chapter 103I.

Fees are contained in Minnesota Statutes, section 103I.208. The current fees, effective July 1, 2009, are listed following Minnesota Rules, part 4725.1836.

Minnesota Statutes, Chapter 103I was changed, effective July 1, 2009, so that federal, state, and local governments are no longer exempt from payment of fees.

*Subp. 4. Reporting measurements.* Depths or heights reported on a permit or notification must be measured from the established ground surface.

Valid casing depths measurements will be from the ground surface and not from the top of the casing above ground.

*Subp. 5. Hours of receipt, valid notification and permit.* A notification is not valid until the notification is received by the commissioner between the hours of 8:00 a.m. and 4:30 p.m., Monday through Friday, excluding holidays, except for emergency notifications and permits according to part 4725.1838. A notification received by facsimile after 4:30 p.m. is not valid until the next business day. A

*permit is not valid until the commissioner has approved the permit. A notification or permit is not valid unless accompanied by the proper fee. Work regulated under a notification or permit must not be done without a valid notification or permit.*

Except for emergency out of water notifications, notification will only be accepted during normal business days (Monday through Friday) during normal business hours (8 a.m. – 4:30 p.m.).

***Subp. 6. Transfer of notification or permit.*** *A permit or notification is not transferable. Only the licensee or registrant who submits the notification, or the licensee or registrant who was issued the permit, may construct or seal the well or boring.*

Notifications cannot be transferred from one license to another or from one property owner to another.

***Subp. 7. Conversion.*** *A well or boring must not be converted to another type of well or boring unless;*

- A. a variance is granted according to part 4725.0410, or;*
- B. the well or boring was constructed by a contractor licensed or registered to construct that type of well or boring, the well or boring complies with the requirements of this chapter for that type of well or boring, and a new notification or permit, and fee if required, is submitted to the commissioner.*

Unless a variance is granted:

- An irrigation well cannot be converted to a domestic water-supply well unless it was constructed to current domestic water-supply rules, e.g., 50 feet of grout in the annulus.
- An irrigation or a domestic water-supply well cannot be converted to a noncommunity water-supply well unless it was constructed to meet current noncommunity water-supply rules, e.g., full length grouting.
- An irrigation, domestic, or a noncommunity water-supply well cannot be converted to a community water-supply well unless it was constructed to meet all of the current community water-supply well rules.
- A monitoring well may not be converted to an environmental bore hole or a remedial well in order to avoid an annual maintenance permit.

***STAT AUTH: MS s 103I.101; 103I.111; 103I.205; 103I.221; 103I.301; 103I.401; 103I.451; 103I.501; 103I.525; 103I.531; 103I.535; 103I.541; 103I.621***  
***HIST: 33 SR 211***

## **4725.1820 NOTIFICATION FOR CONSTRUCTION OF WATER-SUPPLY WELLS.**

*The owner of the property where a water-supply well is to be located, the property owner's agent, a licensed well contractor, or for a drive-point water-supply well, a limited drive-point well or dug well/boring contractor must submit notification of construction of the proposed water-supply well to the commissioner according to this part. This part does not apply to the construction of monitoring wells regulated by part 4725.1830; dewatering wells regulated by part 4725.1825; or drive-point water-supply wells installed by the well owner on the owner's property for residential or agricultural use regulated by part 4725.1849. This part applies to water-supply wells, including wells constructed for the purpose of testing water yields for irrigation, commercial use, residential supply, or a public water system.*

Notification is required **before beginning construction** of a water-supply well, regardless of the length of time the well will be in use.

A **delegated well program** may require a notification or well construction permit. The contractor should contact a representative of the delegated well program in which they are working.

### **SIGNATURE**

The notification must have the signature of either the property owner (or property owner's agent, or well owner if a written agreement exists) or the certified representative of the licensee. The signatures of both are not required. The certified representative of the licensee is not required to wait for written verification that the notification has been received. However, the notification is not valid until the signed notification **and** the fee are received by the MDH. Notifications may be mailed, faxed, or hand-delivered.

### **WELL OWNER AND PROPERTY OWNER**

If a person wants to construct or have a water-supply well constructed on property they do not own (i.e., leased property), then a **written agreement** must exist between the well owner and the property owner as specified in Minnesota Statutes, section 103I.205, subdivision 8. The written agreement must specify which party, the well owner or property owner, is responsible for obtaining a permit or filing the notification, paying applicable fees, and for sealing the well. The buyer of property on a contract for deed (grantee) is considered the property owner for the purposes of this part and a signed statement from the seller (grantor) is not required.

## SUBCONTRACTING

If a licensed contractor files a notification to construct a well and chooses to subcontract the construction of the well to another licensed contractor, the contractor who filed the notification for the well is the contractor responsible for the well. If a well constructed by a subcontractor does not satisfy the requirements of the rules, corrective actions are the responsibility of the licensed contractor who filed the notification. The subcontractor may also face certification, license, or other legal penalties for knowingly violating a law or rule.

## DRIVE-POINT WELL NOTIFICATION

The well-owner constructed drive-point well notification requirements are found in Minnesota Statutes, section 103I.205, subdivision 1, paragraph (d), and Minnesota Rules, part 4725.1849.

## TEST HOLES AND UNSUCCESSFUL WELLS

“**Test holes**” for irrigation or other water supply purposes that are pumped require notifications and fees. “Test holes” drilled only to measure a water level or take soil samples that are not pumped or tested for water quality are environmental bore holes and do not require notification or a fee.

A new notification and fee is not required for an unsuccessful well if the new well depth and construction are similar to the original notification, and the work is completed within 18 months of the original notification submission.

## FEES

For current fees see Minnesota Statutes, section 103I.208. The fee schedule effective July 1, 2009, is listed following Minnesota Rules, part 4725.1836.

*A. A well must not be constructed, deepened through a confining layer, or have casing installed or removed below the frost line until notification is made to the commissioner.*

If a water-supply well has been constructed and a well construction record submitted, a new notification is required if the **well is deepened** through a confining layer or casing is added or removed below the frost line.

The notification must be received by the St. Paul office of the MDH Well Management Section **prior** to well construction or reconstruction.

Installation or repair of a pitless unit or adapter does not require a notification; however, delegated well programs may require a permit. See Minnesota Rules, parts 4725.2750, 4725.3750, and 4725.5550, for additional information regarding the repair of wells and borings.

Remedial wells (a type of water-supply well) constructed on a federal superfund site (CERCLA) are not required to file notifications or pay fees. The wells must comply with all other requirements of the statute and rule.

Conversion of an existing above-grade remedial well to an at-grade well does not require a notification or fee. Submission of an amended well construction record with a scaled map of the well location is recommended.

*B. Notification must be made on a form provided by the commissioner, or in a format approved by the commissioner. The notification must be legible, accompanied by the required fee, and signed by the certified representative of the licensee or the owner of the property where the well is located, or the property owner's agent.*

Contact our St. Paul office for format approval prior to use.

*C. A notification must be completed for each well.*

*D. The notification must include the following information for each well:*

- (1) the name and license number of the licensed contractor;*
- (2) the name, address, and telephone number of the well owner, and property owner if different; and*
- (3) the township number, range number, section and one quartile, and the property street address if assigned, of the proposed well location.*

The address of the well location property is required when one has been assigned.

*E. A new notification must be filed with the commissioner if:*

- (1) a licensed contractor other than the one listed on the original notification constructs the well; or*

The notification fee for a water-supply well as listed in Minnesota Statutes, section 103I.208, and in the fee schedule effective July 1, 2009, is listed following Minnesota Rules, part 4725.1836

When a well owner pays the fee and files the notification and then decides to hire a different contractor than the one listed on the notification, the owner or new contractor must submit a new notification with a new unique well number and a short note explaining the change. The previous unique well number should be included with the note explaining the driller change. No new fee is required with the “**change of contractor**” notification unless the original notification has expired or no fee was paid with the original notification. The new notification must be received by the MDH Well Management Section prior to starting well construction.

The contractor who submitted the original notification should contact the MDH Well Management Section to cancel the unused unique well number. This unused unique well number cannot be reassigned to another well. The unused well record and label should be destroyed by the contractor.

*(2) the well is completed on property other than that listed on the original notification. A new fee is not required for a new notification filed under this item.*

*F. The notification is valid for 18 months from the date it is filed.*

Notification (and permit) fees are **nonrefundable**. One **exception** has been made for water-supply well notifications. A refund will be made to whoever paid a notification when a water-supply well is not drilled and when the refund request is made in writing within 18 months of the initial construction notification. Refunds will not be made if any drilling has taken place (including drilling a dry hole) or if the refund is requested after the 18 month period. Refunds will be made only for water-supply well notifications; not for other types of wells or borings, or for other fees. If a notification fee is paid by a well contractor and the property owner hires another contractor to drill the well, the notification fee may not be transferred.

Water-supply wells must be constructed in accordance with the general requirements of Minnesota Rules, parts 4725.2010 through 4725.3875 and the specific water-supply well requirements of Minnesota Rules, parts 4725.4050 through 4725.6050.

*STAT AUTH: MS s 103I.101; 103I.111; 103I.205; 103I.221; 103I.301; 103I.401; 103I.451; 103I.501; 103I.525; 103I.531; 103I.535; 103I.541; 103I.621; 144.05; 144.12; 144.112; 144.383; 156A.01 to 156A.08; 157.04; 157.08; 157.09; 157.13  
HIST: 15 SR 78; 17 SR 2773; 33 SR 211*

#### ***4725.1825 DEWATERING WELL CONSTRUCTION NOTIFICATION.***

*This part applies to all dewatering wells as defined in part 4725.0100, subpart 24f, including drive-point wells used for dewatering.*

As of July 1, 2009, the notification fee for each dewatering well is \$215 except that a project of five or more wells is assessed a fee of \$1075 (See Minnesota Statutes, 103I.208 for future fee changes). Maintenance permits are still required for dewatering wells not sealed 14 months after construction.

The dewatering well notification process and requirements are the same as those for water-supply wells listed under Minnesota Rules, part 4725.1820. The notification form and fee must be submitted prior to construction.

The definition of “dewatering well” is located in Minnesota Rules, part 4725.0100, subpart 24f. Wells used to “dewater” for control or removal of groundwater contamination are remedial wells, not dewatering wells.

*A. A dewatering well must not be constructed, deepened through a confining layer, have casing installed or removed below the frost line, or completed as an at-grade well until a notification has been made to the commissioner by a dewatering well contractor or well contractor.*

*B. The dewatering well contractor or well contractor must submit to the commissioner a dewatering well construction notification on a form provided by the commissioner, or in a format approved by the commissioner. The notification must be legible and signed by the dewatering well contractor or well contractor.*

The language in “B” was added in the amendments of 2008 to allow for alternative submission of notifications, in particular, electronic or internet submission, when the technology, format, security and other issues are resolved.

*C. A construction notification must be completed for each dewatering well or dewatering well project including any wells deepened through a confining layer, having casing installed or removed below the frost line, or converted to an at-grade well. The notification must indicate whether the dewatering well, or dewatering well project will affect wells used for potable purposes, and if so, what measures will be taken to provide potable water to persons adversely affected by the dewatering.*

*D. The construction notification must include the following information for each well:*

*(1) the name and license number of the dewatering well contractor or well contractor;*

*(2) the name and address of the dewatering well owner, and property owner if different; and*

*(3) the township number, range number, section and one quartile, and the property street address if assigned, of the proposed dewatering well location.*

The address of the well location property is required when one has been assigned.

*E. Construction notifications are not transferable. Only the licensee who submitted the notification is authorized to construct the dewatering well or wells.*

*F. The construction notification is valid for 18 months from the date issued.*

Dewatering wells must be constructed in accordance with the general requirements of Minnesota Rules, parts 4725.2010 through 4725.3875 and the specific requirements of Minnesota Rules, part 4725.6150.

*STAT AUTH: MS s 103I.101; 103I.111; 103I.205; 103I.221; 103I.301; 103I.401; 103I.451; 103I.501; 103I.525; 103I.531; 103I.535; 103I.541; 103I.621; 144.05; 144.12; 144.122; 144.383; 157.04; 157.08; 157.09; 157.13*

*HIST: 15 SR 78; 15 SR 1474; 17 SR 2773; 18 SR 1222; 33 SR 211*

#### **4725.1830 MONITORING WELL CONSTRUCTION PERMIT.**

*This part applies to all monitoring wells, including drive-point wells used as monitoring wells.*



## PERMIT EXCEPTIONS

A permit is required to construct a monitoring well, with a few **exceptions**. Monitoring wells on Native American or federal military reservations are exempt from all regulatory control, including permitting, licensing, and construction requirements. Temporary monitoring wells sealed within 72 hours of construction, and monitoring wells constructed on federal superfund (CERCLA) sites for the remediation phase are exempt from the permit and permit fee, but must comply will all other requirements of the rule and law.

Additional information is found in the comments after Minnesota Rules, part 4725.0200, subpart 1, and below in Item C (2) of this rule part.

## CONVERSION

A permit application must be submitted to the MDH and approved prior to construction of a monitoring well. Environmental bore holes may be drilled without notification or permit. Monitoring wells typically present a greater potential for groundwater impacts. Therefore, plan review and inspection are more necessary. As a result, the MDH will generally not allow conversion of a piezometer or other environmental bore hole to a monitoring well. However, in some cases, conversion may be allowed after submission of a permit application and fee and review of well construction. Once a permit has been obtained for a monitoring well and the well has been constructed, conversion to an environmental bore hole or other use will not be allowed.

*A. A monitoring well must not be constructed, deepened through a confining layer, have casing installed or removed below the frost line, or be converted to an at-grade well until a permit has been issued by the commissioner to the monitoring well contractor, well contractor, or to a limited well screen and pitless adapter and pitless unit contractor for modification to an at-grade well.*

The monitoring well permit is issued to the monitoring well contractor or well contractor, not to the property owner or consultant.

If a monitoring well has been constructed and a well construction record submitted, a new permit is required if the well is deepened through a confining layer or if casing is added or removed below the frost line.

*B. A well contractor or monitoring well contractor must submit to the commissioner a permit application on a form provided by the commissioner, or in a format approved by the commissioner. The application must be legible and signed by the monitoring well contractor or well contractor and the property owner or agent.*

The language in “B” about formats approved by the commissioner of health was added to allow for alternative submission of permits, in particular electronic or internet submission, when the technology, format, security, and other issues are resolved. Contact the St. Paul office of the MDH Well Management Section at 651-201-4600 for information.

Permit forms are available at all MDH Well Management Section district offices, delegated well program offices, or by calling the MDH Well Management Section, St. Paul office.

*C. A permit application must be completed for each monitoring well.*

One permit application form may be used to list all wells to be drilled for a project. The permit application must be submitted and approved before construction begins. Subsequent monitoring wells constructed on the same site should list the same permit number. Each well must be assigned a different Minnesota unique well and boring number.

The MDH may grant verbal approval to construct additional monitoring wells on a site for which a permit has been approved, if the contractor is on-site and determines that additional wells are necessary. The contractor must contact the St. Paul office of the MDH Well Management Section and fax a copy of an amended permit. The fees and written permit amendment must be submitted to the MDH within five working days.

*(1) For monitoring wells used as leak detection devices at a single petroleum bulk storage site excluding tank farms, a single agricultural chemical facility site, or a single motor fuel retail outlet, a single permit application may be completed for all wells on a site drilled under a single contract. A site consists of a single continuous piece of property on which the petroleum bulk storage facility or motor fuel retail outlet is located. The site does not include other properties on which monitoring wells are constructed to evaluate a spill or leak associated with the petroleum facility. All proposed monitoring wells on a site must be listed on the permit.*

Former gas station sites, even if the sites are now used for another purpose, are considered to be “motor fuel retail outlets.” The definition of “**motor fuel retail outlet**” is found after the definition of “**monitoring well**” in Minnesota Rules, part 4725.0100, subpart 30m. The definition of “**petroleum bulk storage site**” is found in Minnesota Rules, part 4725.0100, subpart 31a.

Additional monitoring wells drilled off-site require a separate permit application and fee as specified in rule.

*(2) A construction permit is not required for a temporary monitoring well if the monitoring well is sealed within 72 hours of the time construction on the well begins. A sealing notification is required prior to sealing in accordance with part 4725.1832.*

This “**temporary well**” provision is designed to accommodate methods for rapid and flexible site assessment such as the various push probe technologies, as well as hollow stem auger, and conventional rotary and cable tool methods. It does not apply to wells designed for permanent installation. Temporary wells installed under this provision (without a permit) cannot be converted to permanent wells.

Obtaining a groundwater sample through a push probe, hollow stem auger, etc., constitutes the legal definition of a “monitoring well.” However, a permit is **not** needed to collect groundwater samples by such methods provided the bore hole is sealed within 72 hours after construction begins. The 72-hour period begins when excavation of the earth starts, and ends when the well is permanently sealed.

Temporary monitoring wells are exempt only from permit requirements; all other requirements apply including those pertaining to licensing, drilling machine registration, electric line and gas pipe separation, sealing notification, sealing methods, and sealing reports.

The flow chart following Minnesota Rules, part 4725.1842 summarizes when a permit is required and when a sealing report is required.

*D. A permit application for a monitoring well owned by a person other than the property owner must include a copy of a written agreement meeting the requirements of Minnesota Statutes, section 103I.205, subdivision 8.*

A site access agreement alone is **not** sufficient. One of the following is required: (1) a written agreement, signed by both the well owner and the property owner, that identifies which party will be responsible for obtaining maintenance permits and for sealing the well; or (2) if the property owner refuses to sign the agreement (but still allows the well to be installed), the well owner may, in lieu of a written agreement, state in writing that the well owner will be responsible for obtaining the maintenance permits and sealing the well. A copy of the written agreement must be submitted with the permit application.

*E. The permit application must include the following information for each well:*

- (1) the name and registration number of the monitoring well contractor or license number of the well contractor or limited well/boring contractor;*
- (2) the name and address of the monitoring well owner, and property owner, if different;*
- (3) the township number, range number, section and one quartile, and the property street address if assigned, of the proposed monitoring well location; and*
- (4) the anticipated well depth.*

*F. Permit applications for monitoring wells constructed through a confining layer or into bedrock must include the following information for each well in addition to that required in item E:*

- (1) the diameter of the well;*
- (2) the drilling method;*
- (3) the casing materials;*
- (4) the materials and methods used to grout the well; and*
- (5) a cross-sectional diagram of the well.*

*G. Permit applications for at-grade wells must include the following information for each well in addition to that required in item E:*

At-grade wells are allowed only on a roadway, sidewalk, driveway, or a parking area to accommodate vehicular or pedestrian traffic; they are not allowed in landscaped areas for aesthetic reasons. Every effort should be made to terminate the casing above grade. At-grade casings are not allowed on nonvehicular areas such as boulevards or other “green” areas. Termination “at-grade” means that the top of the casing

is flush with the surrounding grade adjacent to the pad. A concrete pad with approved vault must be installed so that the vault cover is at least 2 inches above the surrounding grade and the concrete pad or apron slopes away from the casing in all directions to prevent surface contaminants from washing into the casing. Additional information is found in Minnesota Rules, part 4725.6850.

- (1) an explanation of why the well casing cannot terminate 12 inches above the established ground surface;*
- (2) a cross-sectional diagram of the well cap and vault or manhole.*

A list of vaults and manholes which meet the at-grade standards is included in the appendix.

An at-grade diagram is included in Minnesota Rules, part 4725.6850

#### *H. The permit is valid for 18 months from the date issued.*

Monitoring well permits are issued to the monitoring well contractor or well contractor (not limited contractors), and are not transferable. If the contractor to whom the permit is issued will not be installing the well and another contractor will be, a new permit application is required. If the property owner (or well owner if a written agreement exists) paid the permit fee (as opposed to it being paid by the contractor or a consultant), the owner may cancel the invalid permit and apply for a new permit with the new contractor's name. If the permit fee was paid by anyone other than the property owner, a new permit application **and** fee are required. In all cases, permit fees are **not** refundable.

The **property owner** is responsible for paying the fee unless a written agreement states otherwise.

As of July 1, 2009, the construction permit fee for each monitoring well is \$215 except in the case of motor fuel retail outlets, agricultural chemical facilities, and petroleum bulk storage sites which are \$215 per site, regardless of the number of monitoring wells (See Minnesota Statutes, section 103I.208 for future fee changes). A "site" is one continuous piece of property. Each off-site monitoring well requires a separate permit and fee. Remedial wells at petroleum sites are not monitoring wells. Remedial wells require a separate notification and fee.

Monitoring wells must be constructed in accordance with the general standards of Minnesota Rules, parts 4725.2010 through 4725.3875 and the specific standards of Minnesota Rules, parts 4725.6450 through 4725.6850.

*STAT AUTH: MS s 103I.101; 103I.111; 103I.205; 103I.221; 103I.301; 103I.401; 103I.451; 103I.501; 103I.525; 103I.531; 103I.535; 103I.541; 103I.621; 144.05; 144.12; 144.122; 144.383; 157.04; 157.08; 157.09; 157.13*  
*HIST: 15 SR 78; 17 SR 2773; 19 SR 1222; 33 SR 211*

## **4725.1831 GROUNDWATER THERMAL EXCHANGE DEVICE PERMITS.**

*This part applies to the construction of a groundwater thermal exchange device (heat pump) with reinjection to an aquifer.*

A groundwater thermal exchange device as defined in Minnesota Statutes, section 103I.005, subdivision 11, means “a heating or cooling device that depends on extraction and reinjection of groundwater from an independent aquifer to operate.”

A groundwater thermal exchange device, often referred to as a “groundwater heat pump,” is a system where water is removed from a well, heat is extracted or added to the water, and the water is injected into a well. Typical systems include a withdrawal well, a heat pump, and an injection well. However, one well, a so-called “standing column” well, may be used for both withdrawal and injection.

This part does not apply to **vertical heat exchangers (heat loops)** which are referenced in Minnesota Rules, part 4725.1833. The groundwater thermal exchange device permit also does not apply to wells used to supply water to a groundwater heat pump which discharges to the shallow subsurface, or a lake, river, stream, or ditch – so called “pump & dump” systems. However, a well notification is required to construct a withdrawal well for these “pump and dump” systems. Surface or shallow subsurface disposal may require a NPDES permit from the MPCA. Surface or shallow subsurface disposal may also be regulated by local governments.

Groundwater thermal exchange systems (or any other well) withdrawing more than 10,000 gallons per day (e.g., 6.9 g.p.m. continuous operation for 24 hours) or 1 million gallons per year (e.g., 1.9 g.p.m. continuous operation for 365 days) require an **appropriations permit** from the DNR.

The appendix contains background information on geothermal systems including groundwater thermal exchange devices.

*A. A groundwater thermal exchange device with reinjection to an aquifer must not be constructed until a permit has been issued by the commissioner to the property owner.*

Permit application forms are available at MDH Well Management Section offices. The permit application must be submitted to the St. Paul office of the MDH Well Management Section.

Minnesota statutes allow a maximum of 200 permits to be issued statewide for small systems having maximum capacities of 20 gallons per minute or less. These are subject to inspection twice a year. A maximum of ten permits may be issued for larger systems having maximum capacities from 20 to 50 gallons per minute. These are subject to inspection four times a year. Larger systems may be allowed under a variance.

*B. The property owner or the property owner's agent must submit to the commissioner a permit application on a form provided by the commissioner, or in a format approved by the commissioner. The application must be legible, and must contain:*

- (1) the name, license number, and signature of the well contractor constructing the wells;*
- (2) the name, address, and signature of the owner of the property on which the device will be installed;*
- (3) the township number, range number, section, and one quartile, and the property street address if assigned of the proposed device location;*
- (4) a description of existing wells and any wells proposed to be constructed including the unique well numbers, locations, well depth, diameters of bore holes and casing, depth of casing, grouting methods and materials, and dates of construction;*

Groundwater thermal exchange device systems may use existing wells, or construct new wells. If existing wells are used, the construction of the wells must meet the standards of these rules. Well records or construction reports must be submitted for all wells.

- (5) a description of the heat pump unit including the manufacturer's name, model number, maximum water flow rate in gallons per minute, name of proposed installer, and proposed installation date;*
- (6) water withdrawal information, pumping schedule with rates in gallons per minute, times and duration, and the total amount of water to be injected into the aquifer;*
- (7) the specifications for piping including the materials to be used for piping, the flow control valve setting, the provisions for pressure testing the system, and the provisions for disinfection of the completed system; and*
- (8) a diagram of the proposed piping system.*

*C. The diagram must show that the proposed piping system includes:*

- (1) a 15 psi pressure valve at the discharge well;*
- (2) a solenoid valve on the discharge side of heat pump unit;*
- (3) a pressure gauge in-line between the pressure valve and solenoid valve;*
- (4) a device to provide automatic shutdown of the system if the discharge line pressure is below 15 psi;*
- (5) an in-line thermometer in the heat pump inlet and outlet lines;*
- (6) a check valve in-line from the supply well;*
- (7) unthreaded taps and shutoff valves in the supply and discharge lines;*
- (8) a filter in the discharge line from the heat pump;*
- (9) a flow control valve and flow meter in the supply line;*
- (10) air release valves; and*
- (11) any other devices to be installed such as pressure tanks or isolation valves.*

*D. The system must comply with chapter 4715.*

*E. The groundwater thermal exchange device must be constructed within 18 months of the date the permit is issued.*

The permit is to construct and operate the injection system. The permit does not have to be renewed in order to operate past 18 months. The permit is in addition to notifications for construction of new wells.

Minnesota Rules, Chapter 4715, is the Minnesota Plumbing Code.

The required permit fee is \$215 and must be paid by the property owner as stated in Minnesota Rules, part 4725.0350. This permit fee is in addition to the \$215 notification fee for each well constructed (See Minnesota Statutes, section 103I.208 for future fee changes).

If a groundwater thermal exchange system will be used for both heating/cooling and for the domestic potable water supply, then the domestic water supply must be protected by either an air gap or one of the following types of backflow prevention devices: (1) Double-Check Valve with Intermediate Atmospheric Vent (DCVIAV), (2) Reduced Pressure Zone Backflow Preventer (RPZ), or (3) Double-Check Valve Assembly (DCVA).

For other installation and construction requirements refer to Minnesota Statutes, section 103I.621.

Well construction must follow the general standards of the rules in Minnesota Rules, parts 4725.2010 through 4725.3875 and the water-supply well standards of Minnesota Rules, parts 4725.4050 through 4725.5850.

*STAT AUTH: MS s 103I.101; 103I.111; 103I.205; 103I.221; 103I.301; 103I.401; 103I.451; 103I.501; 103I.525; 103I.531; 103I.535; 103I.541; 103I.621; 144.05; 144.12; 144.122; 144.383; 157.04; 157.08; 157.09; 157.13*  
*HIST: 17 SR 2773; 18 SR 1222; 33 SR 211*

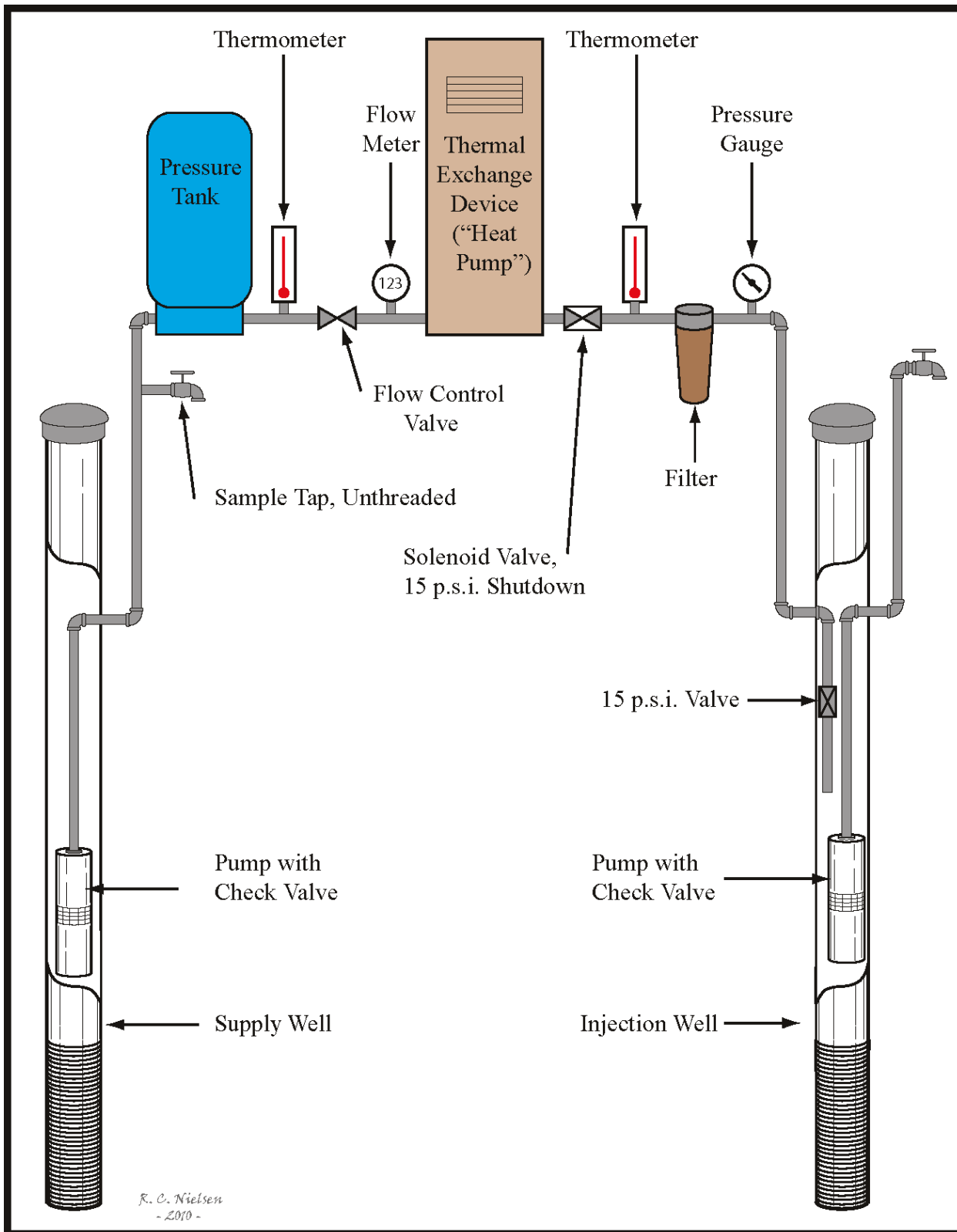

Figure 9. Sample Piping Diagram for Groundwater Thermal Exchange Systems ("Heat Pump")



## **4725.1832 NOTIFICATION FOR WELL SEALING.**

*This part applies to the sealing of wells, including water supply, remedial, monitoring, temporary monitoring, and dewatering wells, as provided by Minnesota Statutes, sections 103I.231, 103I.301, and 103I.315. This part does not apply to the sealing of borings.*

This part applies to the sealing of all wells, including water supply, dewatering, and monitoring, including 72-hour “temporary” monitoring wells. This part does **not** apply to the sealing of borings.

### **WHO MAY SEAL WELLS**

- A well contractor may seal any well.
- A well sealing contractor may seal any well.
- A monitoring well contractor may seal a monitoring well.
- A dewatering well contractor may seal a dewatering well.
- A limited drive-point and dug well contractor may seal a drive-point or dug well.

### **WHO MAY SEAL BORINGS**

- A well contractor may seal any boring.
- A well sealing contractor may seal any boring.
- A monitoring well contractor may seal an environmental bore hole.
- An elevator contractor may seal an elevator boring.
- A vertical heat exchanger contractor may seal a vertical heat exchanger.

*A. A well must not be sealed until the owner of the property where the well is located, the owner's agent, or a licensee or registrant submits notification of proposed sealing of the well to the commissioner. Notification must be on a form provided by the commissioner, or in a format approved by the commissioner. The notification must be legible and must include the following information for each well:*

Contact the St. Paul office of the MDH Well Management Section for format approval prior to use

Notification must be made to the St. Paul office of the MDH Well Management Section **prior to starting** well sealing. Well sealing includes removal of a pump from a well prior to sealing. A \$50 sealing notification fee is required. Delegated well programs may require a permit instead of notification and may charge a different fee.

- (1) the name and licensee number or registrant number;*
- (2) the name, address, and telephone number of the well owner, and property owner if different;*
- (3) the township number, range number, section and one quartile, and the property street address if assigned; and*
- (4) identification of a multiple cased well with an inside casing 8 inches or larger in diameter.*

*B. A new notification must be filed with the commissioner if a licensee or registrant other than the one listed on the original notification seals the well.*

*C. The notification is valid for 18 months from the date filed.*

*STAT AUTH: MS s 103I.101; 103I.111; 103I.205; 103I.221; 103I.301; 103I.401; 103I.451; 103I.501; 103I.525; 103I.531; 103I.535; 103I.541; 103I.621; 144.05; 144.12; 144.383; 157.04; 157.08; 157.09; 157.13*

*HIST: 17 SR 2773; 33 SR 211*

### **4725.1833 VERTICAL HEAT EXCHANGER CONSTRUCTION PERMITS.**

*This part applies to the construction of vertical heat exchangers.*

A “vertical heat exchanger” as defined in Minnesota Statutes, section 103I.005, subdivision 20, means “an earth-coupled heating or cooling device consisting of a sealed piping system installed vertically in the ground to transfer heat to or from the surrounding earth.” Vertical heat exchangers are often referred to as vertical loops, heat loops, or earth loops.

A vertical heat exchanger consists of “U”-shaped piping installed in a drilled hole connected to a heat pump. A heat-transfer fluid is pumped through the loop which removes or adds heat to the ground in order to heat or cool, usually a building.

“Heat loops” installed horizontally in trenches are not regulated under this rule. However, there are minimum isolation distances established between a water-supply well and a heat loop that contains a heat transfer fluid that is a pollutant or contaminant.

*A. A vertical heat exchanger must not be constructed, or have piping installed or removed below the frost line, until a permit has been issued by the commissioner to the well contractor or limited well/boring contractor licensed to construct vertical heat exchangers.*

Only a licensed well contractor or vertical heat exchanger contractor may obtain a permit and drill the holes for a vertical heat exchanger.

A new permit is required for repair of a loop below the frost line, construction of additional loops on an existing system, or construction of any new separate systems added to an existing system after receipt of the construction report. A permit is not required to do normal maintenance such as repair of the vertical heat exchanger piping above the frost line or repair of the circulation pump, heat exchanger, or horizontal piping.

*B. The well contractor or vertical heat exchanger contractor must submit to the commissioner a vertical heat exchanger permit application on a form provided by the commissioner. The application must be legible and signed by the well contractor or vertical heat exchanger contractor and the property owner or property owner's agent.*

*C. A permit application must be completed for each vertical heat exchanger and must include:*

*(1) the name and license number of the well contractor or vertical heat exchanger contractor;*

*(2) the name and address of the owner of the property on which the vertical heat exchanger will be installed;*

*(3) the township number, range number, section and one quartile, and the property street address if assigned, of the proposed vertical heat exchanger;*

*(4) a plan diagram showing the location of the vertical heat exchanger borings, property lines, and structures on the property;*

*(5) the geological materials expected to be encountered by the borings;*

*(6) the number, diameter, and depth of all bore holes drilled to install the vertical heat exchanger piping;*

*(7) the grout materials and grouting method;*

*(8) the type of heat transfer fluid to be used; and*

*(9) the system operating pressure.*

*D. the vertical heat exchanger must be constructed within 18 months of the date the permit is issued.*

Prior to constructing a vertical heat exchanger, a **permit** must first be obtained from the commissioner of health. When applying for a permit, an application must be submitted containing all the required information listed above.

The vertical heat exchanger permit fees payable by the property owner are:

- \$215 for systems less than 10 tons;
- \$425 for systems from 10 to 50 tons; and
- \$650 for systems over 50 tons is \$650.

The permit application must be sent to the St. Paul office of the MDH Well Management Section (See Minnesota Statutes, section, 103I.208 for future fee changes).

Vertical heat exchanger general **construction requirements** are found in Minnesota Rules, parts 4725.2010 through 4725.3875, and specific additional requirements are found in Minnesota Rules, part 4725.7050.

*STAT AUTH: MS s 103I.101; 103I.111; 103I.205; 103I.221; 103I.301; 103I.401; 103I.451; 103I.501; 103I.525; 103I.531; 103I.535; 103I.541; 103I.621; 144.05; 144.12; 144.122; 144.383; 157.04; 157.08; 157.09; 157.13*

*HIST: 17 SR 2773; 18 SR 1222; 25 SR 1207; 33 SR 211*

## **4725.1835 ELEVATOR BORING CONSTRUCTION PERMITS.**

*This part applies to an excavation or hole for installation of an elevator boring.*

*A. An elevator boring must not be constructed until a permit has been issued by the commissioner to the elevator boring contractor or well contractor.*

A permit is required to excavate a hole in the ground (elevator boring), sometimes referred to as a “jack hole,” for the purpose of installing an elevator hydraulic cylinder. A permit is not required from the MDH for “holeless” or “limited-access” hydraulic elevators if the depth of the excavation including the pit and jack hole is less than 10 feet below the lowest landing of the elevator. A permit is also not required from the MDH for cable-type elevators.

*B. An elevator boring contractor or well contractor must submit to the commissioner an elevator boring permit application on a form provided by the commissioner, or in a format approved by the commissioner. The application must be legible and signed by the elevator boring contractor or well contractor.*

*C. The permit must include the following information for each elevator boring:*

- (1) the name and license number of the elevator boring contractor or well contractor;*
- (2) the name and address of the elevator boring owner, and property owner if different;*
- (3) the township number, range number, section and one quartile, and the property street address if assigned, of the proposed boring location; and*
- (4) the anticipated depth of the elevator boring.*

*D. Permit applications for elevator borings constructed through a confining layer must include the following information in addition to that required in item C:*

- (1) the diameter of the boring;*
- (2) the drilling method;*
- (3) the casing materials;*
- (4) the materials and methods used to grout the boring; and*
- (5) a cross-sectional diagram of the boring.*

*E. The permit is valid for 18 months from the date issued.*

A person may not construct an elevator boring unless the person possesses an elevator boring contractor's license or a well contractor's license issued by the commissioner of health.

The elevator boring permit fee is \$215. The fees are established, and changed, in Minnesota Statutes, section 103I.208. The permit application must be sent to the St. Paul office of the MDH Well Management Section.

The elevator boring **permit** preempts local permits except for local building permits. This means that local governments cannot require a permit to drill a jack hole, but they may require a building permit or other permit for the elevator. Minnesota Statutes, section 103I.401, and this rule part establish the requirements for a permit.

**Construction requirements** are found in Minnesota Rules, parts 4725.2010 through 4725.3875 and specific additional requirements for elevator borings are found in Minnesota Rules, part 4725.7250.

*STAT AUTH: MS s 103I.101; 103I.111; 103I.205; 103I.221; 103I.301; 103I.401; 103I.451; 103I.501; 103I.525; 103I.531; 103I.535; 103I.541; 103I.621; 144.05; 144.12; 144.122; 144.383; 157.04; 157.08; 157.09; 157.13*

*HIST: 15 SR 78; 17 SR 2773; 18 SR 1222; 33 SR 211*

### **4725.1836 NOTIFICATION AND PERMIT FEES.**

*The fees specified in Minnesota Statutes, chapter 103I, must accompany all notifications and permit applications. Notification or permit fees may be paid electronically and the permit requests or notifications may be submitted by facsimile. A notification or permit is not valid if payment by check is returned for nonsufficient funds, or electronic payment is refused by the financial institution. Notification and permit application fees shall not be refunded, except that a water-supply well notification fee may be refunded to the person who paid the fee if drilling has not taken place, and a written request for refund is received by the commissioner within 18 months of receipt of the fee.*

Construction and sealing notifications, and permits may be submitted by FAX. Payment may be made by a credit card whether faxed or submitted by mail or in person. Other fees, such as maintenance permits; license, registration, or certification application fees; or variance fees may not be paid by credit card.

The only fee that may be refunded is for water-supply well notifications where drilling has not taken place. A refund will be made to whoever paid a notification when a water-supply well is not drilled and when the refund request is made in writing within 18 months of the initial construction notification. Refunds will not be made if any drilling has taken place (including drilling a dry hole), or if the refund is requested after the 18 month period. Refunds will be made only for water-supply well notifications; not for other types of wells or borings, or for other fees. If a notification fee is paid by a well contractor and the property owner hires another contractor to drill the well, the notification fee may not be transferred. The contractor must request a refund.

*STAT AUTH: MS s 103I.101; 103I.111; 103I.205; 103I.221; 103I.301; 103I.401; 103I.451; 103I.501; 103I.525; 103I.531; 103I.535; 103I.541; 103I.621; 144.05; 144.12; 144.122; 144.383; 157.04; 157.08; 157.09; 157.13*

*HIST: 15 SR 78; 17 SR 2773; 18 SR 1222; 33 SR 211*

**CONSTRUCTION, SEALING, AND MAINTENANCE FEE SUMMARY**  
**January 5, 2010**

**WELL CONSTRUCTION NOTIFICATION**

- \$215 Water-Supply Well Construction Notification
- \$215 Dewatering Well Construction Notification
- \$1075 Dewatering Well Project Construction Notification (more than five wells on a site)

**WELL SEALING NOTIFICATION**

- \$50 Water-Supply, Monitoring, or Dewatering Well Sealing
- \$50 Temporary Monitoring Well Site

**CONSTRUCTION PERMIT**

- \$215 Monitoring Well Construction Permit
- \$215 Monitoring Well Construction Permit for motor fuel retail outlet, agricultural chemical facility site, or petroleum bulk storage site regardless of the number of wells constructed at the site
- \$215 Groundwater Thermal Exchange Device Permit (in addition to the well notification fee)
- \$215 Vertical Heat Exchanger Permit, less than 10 tons
- \$425 Vertical Heat Exchanger Permit, 10 to 50 tons
- \$650 Vertical Heat Exchanger Permit, greater than 50 tons
- \$215 Elevator Boring

**MAINTENANCE PERMIT (Annual Fee)**

- \$175 Water-Supply Well Maintenance Permit for a well that is not in use
- \$175 Monitoring Well Maintenance Permit for a well that is not sealed 14 months after construction. (Government owned monitoring well is \$50)
- \$175 Monitoring Well Maintenance Permit for unsealed monitoring wells 14 months after construction at a fuel outlet or bulk storage site regardless of the number of wells
- \$175 Dewatering Well Maintenance Permit for a well that is unsealed 14 months after construction
- \$875 Dewatering Well Maintenance Permit for more than five unsealed wells on a site 14 months after construction

#### **4725.1837 EXCEPTION TO NOTIFICATION AND PERMIT REQUIREMENTS.**

*A permit or notification is not required for installation of a pump, pumping equipment, pitless unit, pitless adapter, screen, or the repair of an existing well or boring if the repair does not involve deepening the well or boring through a confining layer or having casing installed or removed below the frost line.*

A notification or permit is **not needed** to install or repair a pitless unit or adapter, install or repair a pump, or install or repair a screen. A notification or permit is also not needed to extend casing above the frost line, such as to install a pitless or extend a casing where the grade has been raised. However, delegated well programs may require a permit for this work.

Deepening an existing well or boring through a confining layer, changing a well to at-grade, installing an inner or outer casing below the frost line, or removing and then replacing any casing below the frost line require a notification or permit.

*STAT AUTH: MS s 103I.101; 103I.221; 103I.301; 103I.621; 144.05; 144.12; 144.383; 157.04; 157.08; 157.09; 157.13  
HIST: 15 SR 78; 17 SR 2773; 33 SR 211*

#### **4725.1838 EMERGENCY NOTIFICATIONS AND PERMITS.**

*Notifications and applications for permits may be verbally reported under emergency conditions for construction of water-supply wells, elevator borings, monitoring wells, and dewatering wells, except for monitoring wells and dewatering wells constructed through a confining layer and for at-grade monitoring wells. Emergency conditions are exceptional circumstances where a delay in starting construction poses an immediate and significant danger to health or safety and there is no time for prior notification or obtaining the required permit.*

Emergency notifications and permits must be reported to the St. Paul office of the MDH Well Management Section prior to construction. A voice mail message should be left (651-201-4600) if the emergency occurs after business hours.

*Exceptional circumstances include, but are not limited to, cases where well failure will leave livestock or persons without drinking water, where inaction presents an imminent threat to contamination of the well, boring, or groundwater, where delay will result in collapse or damage to the well or boring, where delay will result in the endangerment of health or safety such as in an unstable excavation, or where such construction is court ordered.*

Scheduling problems, home “closings,” road-weight limit restrictions, and “economic opportunities” do not constitute emergencies.

*A. If emergency conditions affecting construction of a water-supply well, or dewatering well occur during normal business hours, the property owner, the property owner's agent or a licensed contractor may verbally provide to an authorized representative of the commissioner the information required for notification under part 4725.1820 or 4725.1825. If emergency conditions affecting construction of a monitoring well, or elevator boring occur during normal business hours, the contractor may verbally provide the information required for permits under part 4725.1830 or 4725.1835, whichever is applicable, to an authorized representative of the commissioner.*

An authorized representative of the commissioner means an employee of the MDH Well Management Section.

*B. If emergency conditions occur after business hours or on a nonbusiness day, construction of a water-supply well, monitoring well, or dewatering well, or elevator boring may begin if the property owner, property owner's agent, or contractor, as required in item A, telephones the Minnesota Department of Health and leaves a message on the answering service reporting the applicable information required in part 4725.1820, 4725.1825, 4725.1830, or 4725.1835.*

*C. A written notification or written permit application and the applicable fees must be received by the commissioner within five working days after emergency notification of the start of construction of a water-supply well or dewatering well, or within five working days after the start of construction under an emergency permit for a monitoring well or elevator boring. The property owner, the property owner's agent, or a licensed or registered contractor is responsible for submitting a written notification or permit and fee.*

*D. The emergency notification or permit shall be void if construction is not started within 72 hours of verbal reporting.*

*E. All construction and location standards in this chapter shall apply to wells and borings constructed under emergency conditions.*



*F. The commissioner shall not issue emergency permits to, or accept emergency notifications from, contractors who violate the emergency notification or permit requirements.*

When calling in an emergency construction notification or permit, toll-free, 24-hour service is available by calling 800-383-9808.

When calling after business hours, a message must be left with all the required notification information listed above. This must be done **before** beginning construction.

Community public water-supply wells constructed under emergency conditions must be reported personally to the MDH Well Management Section or Drinking Water Protection Section staff prior to construction.

*STAT AUTH: MS s 103I.101; 103I.205; 103I.221; 103I.301; 103I.401; 103I.451; 103I.501; 103I.525, 103I.531; 103I.535; 103I.541; 103I.621; HIST: 15 SR 78; 33 SR 211*

#### **4725.1840 UNSUCCESSFUL COMPLETION OF A WELL OR BORING.**

*If a water-supply well, monitoring well, dewatering well, vertical heat exchanger, or elevator boring for which a notification or permit has been filed is unsuccessful, a new well or boring may be constructed for the same owner on the same property within 18 months of notification or permit approval, without submitting a new construction fee, notification, or permit application if:*

“**Unsuccessful**” means that the water-supply well, elevator boring, or vertical heat exchanger is not completed and put into use. An unsuccessful monitoring well is one that is not completed to desired depth, is not sampled, and is replaced with another. It does not mean a monitoring well that is sampled but does not find contamination. An unsuccessful dewatering well is one that is not pumped, and is sealed and replaced with another. Unsuccessful wells or borings must be sealed by a licensed or registered contractor in accordance with the sealing requirements in Minnesota Rules, part 4725.3850. A sealing notification and fee is not required. Sealing reports must be submitted.

*A. the construction and depth of the new well or boring is not substantially different from the initial well or boring;*

If the new well or boring is anticipated to penetrate a different confining unit or be completed in a different aquifer, a new permit or notification is required.

*B. the person installing the well or boring submits an amended well and boring construction record; and*

*C. the unsuccessful well or boring is sealed according to this chapter, and a sealing record is submitted.*

Unsuccessful wells or borings must be sealed according to Minnesota Rules, part 4725.3850.

If one or more attempts are made to construct a well, or excavate for the installation of an elevator boring and are met with failure, a new notification or permit is not needed if the well or elevator boring excavation ultimately constructed is similar in depth and construction to the previous attempts and if the permit is amended to show the correct location of the final construction or installation. The amended permit may be submitted with the well or boring record. If the property owner or well owner changes, a new permit or notification is needed.

*STAT AUTH: MS s 103I.101; 103I.205; 103I.221; 103I.301; 103I.401; 103I.451; 103I.501; 103I.525, 103I.531; 103I.535; 103I.541; 103I.621; HIST: 15 SR 78; 33 SR 211*

#### **4725.1842 APPROVAL OF CONSTRUCTION PERMITS.**

*The commissioner shall review a permit application upon submission. A permit shall be issued if the application is complete and is in compliance with this chapter.*

Permit applications that are complete and correct are generally reviewed and approved within three working days. If a permit is not filled out completely or is not in compliance with this chapter, it is subject to denial or rejection. A permit application is not approved, and a well may not be drilled, until the contractor has received an official approved permit from the MDH Well Management Section.

*STAT AUTH: MS s 103I.101  
HIST: 15 SR 78*

#### **4725.1845 DENIAL OF CONSTRUCTION PERMIT APPLICATION.**

*Subpart 1. Grounds for denial of application. The commissioner may deny a permit application or revoke a permit for construction of a monitoring well, groundwater thermal exchange device, vertical heat exchanger, or elevator boring if:*

*A the person constructing the well or boring is not licensed or registered according to this chapter;*

*B. information submitted in the permit application is determined to be incomplete, incorrect, omitted, false, or misrepresented;*

*C. the construction of the well or boring would not be in conformance with this chapter;*

*D. issuance of the permit conflicts with statute or rule;*

*E. a provision of the permit is violated;*

*F. the well or boring would be constructed into or through contaminated soil or groundwater, and construction or use of the well or boring would result in contamination of a well or boring, allow contamination to spread, or would adversely affect groundwater remediation; or*

*G pumping from the well or boring would intercept groundwater contamination and construction or use of the well or boring would result in contamination of a well or boring, allow contamination to spread, or would adversely affect groundwater remediation.*

*Subp. 2. **Notice requirement.** The commissioner shall give the applicant or permit holder written notice of the permit application denial or permit revocation. The notice shall state the reason for denial or revocation. A denied permit application or revoked permit may be revised or corrected and resubmitted to the commissioner for reconsideration.*

*STAT AUTH: MS s 103I.101; 103I.111; 103I.205; 103I.221; 103I.301; 103I.401; 103I.451; 103I.501; 103I.525, 103I.531; 103I.535; 103I.541; 103I.621; HIST: 15 SR 78; 33 SR 211*

#### **4725.1848 WELL MAINTENANCE PERMITS.**

##### **Subpart 1. Permit required.**

*A. Annual maintenance permits are required for monitoring wells and dewatering wells that were constructed after January 1, 1990, and are not permanently sealed within 14 months of construction.*

*B. Annual maintenance permits are required for wells, including monitoring wells, dewatering wells, and water-supply wells, that are not in use and not sealed.*

**Maintenance permits** allow the property owner to maintain a well on an annual basis. The permit requires an annual fee. A maintenance permit will not be granted if the well must be sealed under conditions established in Minnesota Statutes, Chapter 103I. Conditions may be placed on the maintenance permit, such as repair of defective casing or extension of casing above grade. The issuance of a maintenance permit does not guarantee that the well will function properly for someone's intended use or that a water-supply well constructed before the adoption of the rules (1974) meets the current standards of the rules. The maintenance permit does not exempt the owner from the ultimate sealing of the well.

**Monitoring wells and dewatering wells** constructed after January 1, 1990, must have a maintenance permit if they are in use and not sealed within 14 months of construction. Dewatering wells and monitoring wells that are not in use and not under a maintenance permit must be sealed.

**Water-supply wells** must have a maintenance permit if they are not in use and not sealed.

A well that is not in use means a well that is not used on a regular basis, typically interpreted to mean at least annually. According to Minnesota Statutes, section 103I.0100, a “well that is in use” means a well that operates on a daily, regular, or seasonal basis. A well in use includes a well that operates for the purpose of irrigation, fire protection, or emergency pumping.

Maintenance permits are not required or issued for **borings**. A boring that is not in use must be placed in use or sealed.

**Subp. 2. Permit application.** *The owner of the property where the well is located must submit to the commissioner a maintenance permit application on a form provided by the commissioner. The application must be legible, accompanied by the correct fee, and signed by the property owner where the well is located. The permit application shall include the following information for each well:*

The property owner is responsible for obtaining the permit unless the well owner and the property owner have a written agreement as required by Minnesota Statutes, section 103I.205, subdivision 8.

*A. the name, telephone number, and address of the property owner and well owner, if different;*

*B. the legal description of the well location; and*

*C. the Minnesota unique well number. If the unique number is not known, the depth, diameter, and construction of the well must be reported.*

*The commissioner shall review a permit application upon submission. A permit shall be issued if the application is complete and is in compliance with this chapter. A permit shall not be issued for a well that is required to be sealed by this chapter or Minnesota Statutes, section 103I.301.*

Permit applications may be obtained from the St. Paul office of the MDH Well Management Section or from any MDH Well Management Section district office.

If a well falls into one of the following categories, then it is not a candidate for a maintenance permit, and must be sealed:

- The well is contaminated or may contribute to contamination;
- The well was attempted to be sealed but the provisions of this chapter were not followed; or
- Due to its location, construction, or maintenance, continued use of the well endangers groundwater quality or is a safety or health hazard.

A well or boring must be sealed by a registered or licensed contractor consistent with the provisions of this chapter.

**Subp. 3. Permit conditions.** *The conditions in this subpart apply to maintenance permits.*

*A. Maintenance permits are not transferable. If ownership of the property changes, an application must be made for a new maintenance permit.*

*B. A maintenance permit is valid for one year from the date it is issued.*

The MDH Well Management Section will mail maintenance permit renewal applications to persons who have been issued maintenance permits.

*C. A maintenance permit does not allow construction or repair that would require notification or a permit according to this chapter.*

*D. The commissioner may deny a permit application or revoke a permit for violation of this chapter. The commissioner shall give the applicant or permit holder written notice of the permit application denial or permit revocation. The notice shall state the reason for denial or revocation.*

*Subp. 4. **Well maintenance permits.** An annual well maintenance permit is required for an unsealed dewatering well, monitoring well, or water-supply well that is not in use or that is inoperable. The owner of the property on which such a well is located must submit the annual permit fee along with the permit application, or have the well sealed.*

The annual maintenance permit fee is \$175. See Minnesota Statutes, section 103I.208.

Water-supply well maintenance permits are required for wells which are not in use. If a water-supply well is in use, a maintenance permit is not required. Monitoring well and dewatering well maintenance permits are for wells which **are** in use 14 months after construction.

*Subp. 5. **Monitoring well maintenance permits.** The provisions in items A to C apply to monitoring wells constructed after January 1, 1990.*

*A. The owner of property on which an unsealed monitoring well is located must obtain a maintenance permit starting 14 months after construction of the well and must pay the required permit fee. The permit must be renewed annually until the well is sealed.*

*B. A maintenance permit application must be completed for each monitoring well. However, a single permit application may be completed for monitoring wells used as leak detection devices at a petroleum bulk storage site or a motor fuel retail outlet. The permit must list each well and include the well location and unique well number. A site or outlet consists of a single continuous piece of property on which the petroleum bulk storage or retail motor fuel outlet is located. The site does not include other properties on which monitoring wells are constructed to evaluate a spill or leak associated with the petroleum facility.*

*C. Monitoring wells that are inoperable or not in use, or for which no maintenance permit has been obtained 14 months after construction, must be permanently sealed.*

The annual monitoring well maintenance permit fee is \$175. For each motor fuel retail outlet, agricultural chemical facility,\* or bulk storage site, the fee is \$175 for each site regardless of the number of unsealed monitoring wells on the site.

\* Agricultural chemical facilities were added to petroleum bulk storage and motor fuel sites by legislative action.

*Subp. 6. Dewatering well maintenance permits. The conditions in items A to C apply to dewatering wells constructed after January 1, 1990.*

*A. No later than 14 months after construction of a dewatering well, the owner of the property on which a dewatering well is located must obtain a maintenance permit for an unsealed dewatering well and must pay the required permit fee. The permit must be renewed annually for wells that are in use.*

*B. A maintenance permit for a dewatering project of ten or more dewatering wells must list each well and include the well location and unique well number.*

*C. Dewatering wells that are inoperable or not in use, or for which no maintenance permit has been obtained, must be permanently sealed.*

The annual maintenance permit fee for a dewatering well is \$175. The annual fee for a dewatering well project is \$875 providing there are five or more unsealed dewatering wells on the site.

*STAT AUTH: MS s 103I.101; 103I.111; 103I.205; 103I.221; 103I.301; 103I.401; 103I.451; 103I.501; 103I.525; 103I.531; 103I.535; 103I.541; 103I.621; 144.05; 144.12; 144.383; 157.04; 157.08; 157.09; 157.13*

*HIST: 15 SR 78; 17 SR 2773; 18 SR 1222; 33 SR 211*

#### ***4725.1849 PROPERTY OWNER OR LESSEE DRIVE-POINT WATER-SUPPLY WELL CONSTRUCTION NOTIFICATION.***

*Subpart 1. Scope. This part applies to drive-point water-supply wells constructed by an individual on property that is owned or leased by the individual and that is used for agricultural purposes or as the individual's place of residence. The construction, maintenance, and repair of the drive-point well must comply with parts 4725.2010 to 4725.5650. This part does not grant authority for the individual*

*to seal the drive-point well. This part does not apply to drive-point water-supply wells constructed by a well contractor, drive-point wells installed for purposes other than water supply, or to wells other than drive-point wells installed by the property owner or lessee.*

A property owner may install a drive-point water-supply well themselves (or install a water-supply well by another method) only on property they own or lease and use for farming or agricultural purposes or as the person's residence. A property owner may not construct a monitoring well or any other type of well or boring.

A **drive-point** well, sometimes referred to as a "sand-point," or just a "point," is a well constructed with a pointed well screen attached to sections of pipe, that is forced or driven into the ground with a hammer, maul, or weight. A drive-point well usually meets the definition of "sensitive water-supply well." The greater isolation distances described in Minnesota Rules, part 4725.4450, apply to sensitive wells.

*Subp. 2. **Notification.** Written notification of construction of a drive-point well installed by a property owner must be filed with the commissioner within ten days after completion of the well. The owner of the drive-point well must provide the following information on a notification form provided by the commissioner:*

- (1) the name, address, and telephone number of the drive-point well owner and property owner, if different;*
- (2) the legal description of the well location; and*
- (3) the date the well was constructed.*

This less stringent notification and fee exemption for drive-point wells installed by a property owner was established by the Minnesota Legislature in Minnesota Statutes, Chapter 103I.

Notification forms may be obtained from MDH Well Management Section offices or from retail sellers of drive-points. The form is contained in the drive-point well brochure, which explains the notification requirements and summarizes requirements of the rules.

The **drive-point well construction notification does not apply** to:

- Drive-point wells installed by a contractor. A notification or permit and fee are required prior to construction; or
- Wells other than drivepoints installed by a property owner (a property owner may construct a domestic well or irrigation well themselves by methods other than a drive-point, but must submit a regular notification and fee before construction).

*Subp. 3. **Retail sale of drive-point well screens.** A person who sells drive-point well screens at retail must provide each buyer with a copy of the notification form and informational materials provided by the department*

*The commissioner shall provide copies of the drive-point notification form and information about well regulations to retail sellers of drive-point well screens.*

This requirement applies to hardware stores, plumbing supply companies, mail order outlets, plumbers, well contractors, or other persons who sell drive-points at retail for the purpose of installing or repairing a well. The rule subpart does not apply to sales for purposes other than installation of a well. The subpart also applies only to the sale of the drivepoint itself, not to the sale of casing or pumps. The MDH Well Management Section has prepared a drive-point well brochure which provides a summary of the drive-point well construction requirements.

**A summary of only a few drive-point well requirements** follows:

- All potable water-supply wells must have a minimum of 15 feet of watertight casing.
- The isolation distances apply to drivepoints used for lawn or garden irrigation. The distances are doubled from contamination sources entering the ground (drainfield, privy, animal yard, etc.) for sensitive wells with less than 50 feet of watertight casing and not penetrating at least 10 feet of impervious material such as clay.
- A well may not be buried, in a pit, or within a building, including a basement, except for a well house only used for the well, pump or pumping equipment, or water treatment equipment.
- A suction line may not be buried unless it is contained in concentric piping.
- The casing of a well may not be “pulled” and the soil collapsed when sealing a well (property owners cannot legally seal wells).

*STAT AUTH: MS s 103I.101; 103I.111; 103I.205; 103I.221; 103I.301; 103I.401; 103I.451; 103I.501; 103I.525; 103I.531; 103I.535; 103I.541; 103I.621; HIST: 15 SR 78; 33 SR 211*

**4725.1850 [Repealed, 15 SR 78]**



**End  
of  
Permits and Notifications Section**

## **4725.1851 WELL AND BORING RECORDS.**

*Subpart 1. General. A licensee, registrant, or property owner or lessee for a well constructed according to Minnesota Statutes, section 103I.205, subdivision 4 paragraph (e), clause (1), must submit an accurate, verified, legible written record of well or boring construction or sealing on forms provided by the commissioner, or in a format approved by the commissioner, containing the information in subparts 2 to 4 within 30 days after completion of the work. A written construction record is not required for any well or boring sealed within 30 days of the time construction began and for which a sealing record is submitted.*

Construction and sealing records are preprinted forms distributed by the St. Paul office of the MDH Well Management Section. Extra copies may be obtained by contacting the MDH Well Management Section. These forms are used for wells and borings throughout the state, including delegated well programs.

### **CONSTRUCTION RECORD**

The **construction record** is part of a **four-part packet** which includes a construction notification form, a multi-copy construction record form, a metal well tag, and a water sample identification card. The **unique number** (six-digit number) is preprinted on the form and used to coordinate permits, construction records, and water sample results. All four parts of this packet are used for water-supply wells. Only the construction record and metal well tag are used for monitoring wells; the water sample card and notification form may be discarded. Only the construction record is used for borings, although it is recommended that the tag be attached to the casing, even though it is not required. In the future, individual forms may be developed for different types of wells and borings, but for the present, all wells and borings are reported on the same form except for vertical heat exchangers.

### **SEALING RECORD**

The **sealing record** is used to report the sealing of wells and borings. The sealing record has a preprinted **“H” series number** used to coordinate sealing notifications and sealing reports. If the well or boring was assigned a (six-digit) unique number when constructed, was later assigned a unique number by the Minnesota Geological Survey (typically a six digit, 200,000 series number), or if a county has assigned a **“W” series number** (**“W”** followed by five digits) the number should be reported on the form. Addition of the unique number or **“W” series number** eliminates considerable confusion.

The flow chart following Minnesota Rules, part 4725.1842, explains the reporting requirements for monitoring wells and environmental bore holes.

### **SUBMISSION OF RECORDS**

Construction records must be **submitted within 30 days** of completion unless the well or boring is sealed within 30 days of the date construction **began**, not 30 days from the date construction was completed. Sealing records are required for the sealing of any well or boring, including 72-hour-“temporary” monitoring wells.

“Completion of work” means the date on which the installation of the pump or pumping equipment is finished, the date on which construction of the well or boring is completed if a pump or pumping equipment is not installed by the person constructing the well or boring, the date that construction work regulated by this chapter is completed, the date the well or boring is put into service, or the date that the permit or notification expires, whichever occurs first.

“Completion” is not related to payment, or failure to pay, the bill. It is a violation of the rules and the law to withhold the record simply because a bill is not paid.

The department matches notifications and permits submitted with construction records received at the end of each licensing or registration year. Licenses and registrations are not renewed if the contractor has not submitted the necessary records. If a well or boring was not completed because of weather, seasonal-use cabins, etc., the contractor should document the reason for the delay on the license or registration renewal.

All of the state **copies of the records must be submitted to the MDH Well Management Section** (or the delegated well program) within 30 days of completion of construction or sealing. The local copy must be given to the delegated well program if the well is regulated by a delegated well program. If there is not a delegated well program, the local copy may be discarded. The state or delegated well program will distribute the government copies. It is the contractor's responsibility to give the property owner the owner's copy. The contractor copy should be retained by the contractor.

The MDH Well Management Section is evaluating electronic submission of records. This may occur in the future but is currently not operational.

*A. A new or amended record is required if a notification or permit is required under parts 4725.1820 to 4725.1838.*

If an existing well or boring is changed to at-grade, casing is added or removed below the frost line, or if the well is deepened through a confining layer, a **new record** is required. It is permissible to amend the existing record with the changes made. If alterations are made to a well or boring that do not require a permit or notification, the contractor is urged to send in an amended record, however it is not required.

For information on reporting hydrofracturing, see Minnesota Rules, part 4725.5475.

*B. The licensee or registrant must furnish the owner or owner's agent one copy, retain one copy, and submit the remaining copies to the commissioner, except that where a local board of health has been delegated authority under Minnesota Statutes, section 103I.111, the remaining copies must be submitted to the delegated program.*

A list of **delegated well programs** and addresses is included in the appendix. The Well Management News newsletter should be checked for updates.

*C. A single record may be used to report more than one temporary monitoring well, dewatering well, or environmental bore hole if all the wells or borings on the record are located on a continuous parcel of property, the well or boring depths do not vary by more than 25 feet, and the wells or borings terminate in the same*

*geologic formation. All wells or borings must be of the same type. A map must be attached to the record containing multiple wells or borings, showing all well or boring unique numbers, and locations with distances and directions in relation to recognizable landmarks.*

This applies to construction and sealing reports. In order to be **listed on a single record**, conditions must be met:

- This applies only to temporary monitoring wells, dewatering wells, and environmental bore holes;
- The wells or borings must be located on a single continuous property owned by one person;
- The well or boring depths must be within 25 feet of each other. For example, if the deepest well is 40 feet, then the shallowest well that can be listed on the same form is 15 feet; and
- The wells or borings must terminate in the same formation. Wells or borings which terminate in different formations, in formations separated by a confining layer, or that have different water levels may not be reported on the same form. For example, if one well is completed above a confining layer, and another one completed in the confining layer, they must be reported on separate forms; and
- All wells or borings must be of the same type.

When multiple wells or borings are reported on a single construction or sealing report, a **site map** must be drawn in the “Remarks” section of the record or on an attached sheet of paper, and must include the location of all wells or borings, unique well numbers, and construction or sealing dates. The map must also include some **reference feature** (i.e., the intersection of two roads) so the site can be located by MDH staff. The unique number is important when tracking a well or boring for maintenance permits, license renewals, disclosures, water quality reports, and property transfers. Missing or incorrect **unique well numbers** on well sealing records will result in complications for property owners, well owners, and well contractors in the future. Contractors are strongly urged to search (by checking with the MDH, Minnesota Geological Survey [MGS], or the County Well Index [CWI] database) for unique well numbers prior to sealing wells.

Wells, such as temporary monitoring wells, or borings, that are sealed within 30 days of construction require only a sealing record and do not require a construction record. Well sealing information can be entered on one sealing record under one number. All other wells or borings must have individual unique well numbers and may be entered on one record, provided that they meet the conditions listed above.

A construction record or a sealing record **must contain only one type of boring or well**, even if the criteria of same property, same depth, and same geology are met. For example, if an individual is installing both environmental bore holes and monitoring wells on the same property at the same depth, a separate record must be used for the environmental bore holes and for the monitoring wells. One record must not have more than one type of well or boring listed.

A single vertical heat exchanger permit is issued for all of the borings constructed under the permit. Because of this, all vertical heat exchanger borings for one permit may be reported on a single construction or sealing record.

*D. All depth measurements must be reported from the established ground surface.*

**Subp. 2. Construction records.** Construction records for wells and borings must contain the information in subpart 3, items A to F, and the following information:

- A. intended use;
- B. depth;
- C. drilling method;
- D. casing material, diameter, and depth;
- E. bore hole diameters and depths;
- F. gravel pack and screen type and depth interval, or open hole interval;
- G. static water level;
- H. type, amount, and intervals of grout or sealing materials;
- I. wellhead description including pitless adapter manufacturer and model if installed, and type of casing protection if installed;
- J. date of completion;
- K. pump and pumping equipment description;
- L. description of the geological materials penetrated by the well or boring using terms in subpart 4;
- M. hydrofractured interval if hydrofractured; and
- N. drilling fluid used.

**Subp. 3. Sealing record.** A sealing record must be submitted for all wells and borings sealed. The sealing record must contain the following information:

- A. name and address of the property owner, and the well owner if different;
- B. name, license or registration number of the contractor doing the work, name of the driller performing the work, and the signature of the certified representative;
- C. date work was completed;
- D. the county, township, range, section and three quartiles, and the property street address if assigned, of the well or boring;
- E. a map showing the well or boring location with distances and directions in relation to recognizable landmarks;
- F. for records submitted under subpart 1, item C, the location data at the center of the project, the number of wells or borings included on the record, and a sketch map showing the location of each well or boring;
- G. a description of the geological materials penetrated by the well or boring or a description of material penetrated by the nearest well or boring for which records are available, using terms in subpart 4;
- H. the original well or boring depth, if known, and current well or boring depth;
- I. the approximate date of construction;
- J. the grout or sealing materials, quantities, and intervals;
- K. the casing type, diameter, and depth if present;

- L. the screen or open hole depth interval if present;*
- M. a description of any obstruction or pump, if present;*
- N. the method of sealing the annular space around the casing, if present; and*
- O. a description of the wellhead completion before sealing was performed.*

Construction and sealing records must be signed by the certified representative of the licensee or registrant who filed the permit or notification. Records signed by other persons will be returned to the licensee or registrant for the correct signature.

It is critical that the construction and geology of a well or boring be known before sealing the well. This is extremely important when sealing wells or borings where the possibility of obstructions, ungrouted liners or sleeves, or multi-aquifer construction may exist.

**Subp. 4. Geological materials.** *The geological materials penetrated in drilling a well or boring must be reported. The person completing the record must include the rock and unconsolidated material types, color, and relative hardness. The grain size must be reported for unconsolidated materials and may be based on field observation without technical size measurement. Geological materials must be described using the terms in items A and B, terms contained in the Dictionary of Geological Terms, Third Revision, by the American Geological Institute, or ASTM Standard D2487-00*

ASTM Standard D2487-00 is the Classification of Soils for Engineering Purposes and is largely based on the Unified Soil Classification System of the U. S. Government.

**A. Unconsolidated materials:**

<i>Material</i>	<i>Diameter Millimeters</i>	<i>Diameter Inches</i>	<i>Screen Slot No.</i>	
			<i>From</i>	<i>To</i>
<i>(1) Clay</i>	<i>Up to 0.005</i>	<i>Up to 0.0002</i>	<i>-</i>	<i>-</i>
<i>(2) Silt</i>	<i>0.005-0.062</i>	<i>0.0002-0.0025</i>	<i>-</i>	<i>-</i>
<i>(3) Fine Sand</i>	<i>0.062-0.250</i>	<i>0.0025-0.0100</i>	<i>2</i>	<i>10</i>
<i>(4) Medium Sand</i>	<i>0.250-0.500</i>	<i>0.0100-0.0200</i>	<i>10</i>	<i>20</i>
<i>(5) Coarse Sand</i>	<i>0.500-1.000</i>	<i>0.0200-0.0400</i>	<i>20</i>	<i>40</i>
<i>(6) Very Coarse Sand</i>	<i>1.000-2.000</i>	<i>0.0400-0.0800</i>	<i>40</i>	<i>80</i>
<i>(7) Fine Gravel</i>	<i>2.000-4.000</i>	<i>0.0800-0.1600</i>	<i>80</i>	<i>160</i>
<i>(8) Coarse Gravel</i>	<i>4.000-62.500</i>	<i>0.1600-2.5000</i>	<i>160 and larger</i>	
<i>(9) Cobbles</i>	<i>62.500-250.000</i>	<i>2.5000-10.0000</i>	<i>-</i>	<i>-</i>

This is the particle size scale of Wentworth.

## **B. Rock:**

*(1) basalt, which is a very fine-grained, dark igneous rock, commonly black, dark gray, or dark red-brown in which the mineral grains cannot be distinguished with the unaided eye;*

Basalt is a heavy dark rock with a fine-grained texture. Small green particles may be visible. Cavities in the rock may be filled with minerals of contrasting color. Basalts are found in the northeastern part of the state. Sometimes basalt is referred to as “trap rock.”

*(2) carbonate rock, which is a sedimentary rock consisting of limestone and dolomite or dolostone;*

*(3) dolomite or dolostone, which is a sedimentary rock composed primarily of the mineral dolomite (calcium-magnesium carbonate), which effervesces weakly in dilute hydrochloric acid;*

Dolomite may be difficult to distinguish from limestone. It is common for geologic formations to contain both limestone and dolomite. Limestone and dolomite may both contain fossils. Dolomite will only produce a slight “fizz” (effervesce) when a drop of hydrochloric acid is placed on a rock sample. Limestone will strongly effervesce.

*(4) gabbro, which is a dark-colored, basic intrusive igneous rock comprised principally of basic plagioclase (commonly labradorite or bytownite) and clinopyroxene (augite);*

*(5) gneiss, which is a foliated rock formed by regional metamorphism, in which bands or lenticles of granular minerals alternate with bands or lenticles in which minerals having flaky or elongate prismatic habits predominate;*

*(6) granite, which is a plutonic rock in which quartz constitutes ten to 50 percent of the felsic components and in which the alkali feldspar/total feldspar ratio is generally restricted to the range of 65 to 90 per cent;*

Granite is a hard, dense igneous rock typically light to medium colored. Individual mineral grains can typically be seen in granite (patches of different color) but there are not pore spaces between the grains. Granite may produce water from the weathered portion often found at the top of the granite (regolith or saprolite) or from fractures in the rock. Unweathered or unfractured granite will not produce water. Granite may be pink, pink and grey, black and white, and other color combinations. Granite is found at the surface in the Minnesota River Valley, near St. Cloud, and in parts of northeastern Minnesota and below the glacial sediments and sedimentary rocks throughout much of the state.

*(7) iron formation, which is a chemical sedimentary rock, typically thin bedded and/or finely laminate, containing at least 15 percent iron of sedimentary origin, and commonly but not necessarily containing layers of chert;*

*(8) limestone, which is a sedimentary rock composed primarily of the mineral calcite (calcium carbonate), which effervesces freely in dilute hydrochloric acid;*

Limestone is a rock which contains calcium carbonate (lime). Limestone may contain fossil plants and animals (often shells). A drop of hydrochloric acid placed on limestone will produce a “fizz.” Limestone may be solution weathered which results in the “karst” features of sinkholes and caves. Rapid drilling fluid loss is a problem in karst limestone. Limestone is often white, tan, or grey in color.

*(9) metavolcanic (rock), which is a volcanic rock that shows evidence of having been subjected to metamorphism;*

*(10) quartzite, which is a very hard sandstone, consisting chiefly of quartz grains that have been so completely and solidly cemented with secondary silica that the rock breaks across or through the grains rather than around them, or a granoblastic metamorphic rock consisting mainly of quartz, which is formed by recrystallization of sandstone or chert by metamorphism;*

*(11) sandstone, which is a sedimentary rock consisting of cemented or otherwise compacted sediment composed predominantly of sand-sized particles generally of quartz;*

Sandstone consists of individual grains of sand cemented together by calcium (lime), iron, silica, or other materials. Sandstones may range in hardness from extremely durable materials approaching the hardness of quartzite, to materials which will appear in drill cuttings as loose sand grains. Sandstone is often tan, white, brown, or yellow, but may be red or green. Sandstones are found predominately in the southeastern and western portions of the state.

*(12) schist, which is a strongly foliated crystalline rock, formed by dynamic metamorphism, that can be readily split into thin flakes or slabs due to the well developed parallelism of more than 50 percent of the minerals;*

*(13) shale, which is a sedimentary rock consisting of compacted or cemented silt and clay;*

Shale is a laminated sediment comprised of fine grained materials. Shales are often gray, green, or black, but may be brown or red. Shale will usually split along bedding planes into flat pieces. Shale may be sticky or slippery when exposed to water. Shales may “ball-up” or swell when drilled, and may be relatively soft. Shale is found predominately in the southeastern and northwestern part of the state.

*(14) slate, which is a fine-grained, hard, dark-colored metamorphic rock derived from shale, which typically is gray and which splits readily into flat pieces; and*



*(15) volcanic (rock), which is a generally finely crystalline or glassy igneous rock resulting from volcanic action at or near the earth's surface.*

Igneous and metamorphic rocks are a large group of generally hard, poor water-producing rocks. This group includes the Sioux quartzite ("red rock") of southwestern Minnesota, the gneiss of southwestern Minnesota (banded rock which looks somewhat like granite), slate (hard shale, sometimes referred to as "ledge"), iron formation, and other rock types. If the specific rock type is known (such as quartzite, granite, or slate), it should be reported, otherwise, the term "igneous or metamorphic" should be reported.

*STAT AUTH: MS s 103I.101; 103I.111; 103I.205; 103I.221; 103I.301; 103I.401; 103I.451; 103I.501; 103I.525; 103I.531; 103I.541; 103I.621; 144.05; 144.12; 144.383; 157.04; 157.08; 157.09; 157.13*

*HIST: 17 SR 2773; 33 SR 211*

#### **4725.1855 CUTTING FORMATION SAMPLES.**

*A licensee or registrant must submit cutting samples as specified in this part when the commissioner determines that samples are needed to provide subsurface geological and hydrological information for the state water information system.*

*A. The commissioner shall notify licensees and registrants of the areas from which cutting samples are required and provide licensees and registrants operating within the areas with maps or lists indicating counties, townships, sections, or other designated areas where cutting samples are required.*

*B. Licensees and registrants so notified and supplied shall collect cutting samples during the course of drilling in the designated areas according to the requirements specified. Licensees or registrants not supplied with sample collecting materials but who drill in an area designated for sampling shall notify the commissioner. Licensees or registrants shall collect the cutting samples in a manner representative of the materials encountered. Samples must be taken at five-foot intervals and at every change in geological material type. The cuttings must be placed in the sample bags provided, which shall have an attached tag on which the unique number, owner's name, location, and sample depth must be written.*

*C. Licensees or registrants shall notify the commissioner within 30 days of completion of work, so that the cutting samples can be collected. Until collected, the licensee or registrant shall store the samples protected from weather and disturbance and segregated by unique number and depth interval.*

Sample taking may be required in areas such as special well and boring construction areas or special mapping areas. The contractor will be notified when submitting the well notification if cutting samples will need to be taken.

When sampling is required, care should be taken to assure that good, clean, accurate samples are taken.

*STAT AUTH: MS s 103I.101; 103I.111; 103I.205; 103I.221; 103I.301; 103I.401; 103I.451; 103I.501; 103I.525; 103I.531; 103I.541; 103I.621; 144.05; 144.12; 144.383; 157.04; 157.08; 157.09; 157.13*

*HIST: 17 SR 2773; 33 SR 211*

***4725.1860 [Repealed, 17 SR 2773]***

***4725.1900 [Repealed, 17 SR 2773]***

***4725.2000 [Repealed, 17 SR 2773]***

**End  
of  
Records, Samples Section**

## **WELL AND BORING GENERAL CONSTRUCTION AND USE REQUIREMENTS**

### **4725.2010 APPLICABILITY.**

*The general construction and use requirements specified in parts 4725.2010 to 4725.3875 apply to all wells and borings except exploratory borings regulated under chapter 4727. The additional requirements or exemptions in parts 4725.4050 to 4725.6050 apply to water-supply wells. The additional requirements or exemptions in part 4725.6150 apply to dewatering wells. The additional requirements or exemptions in parts 4725.6450 to 4725.6850 apply to monitoring wells and cased environmental bore holes. The additional requirements or exemptions in part 4725.7050 apply to vertical heat exchangers. The additional requirements or exemptions in part 4725.7250 apply to elevator borings. The additional requirements or exemptions in part 4725.7450 apply to environmental bore holes.*

This portion of the rules (Minnesota Rules, parts 4725.2010 to 4725.3950) applies to all wells and borings including water-supply wells (including public and private water supplies, sandpoints, dug wells, irrigation wells, remedial wells, and heat pump wells), monitoring wells, dewatering wells, environmental bore holes, elevator borings (excavations for elevator cylinders, “jack holes”), and vertical heat exchangers. Rule parts after Minnesota Rules, part 4725.3875, include additional requirements or exemptions for specific types of wells or borings.

The rules in Minnesota Rules, Chapter 4725, apply to new construction, repair, and sealing of existing wells and borings.

Minnesota Rules, Chapter 4727 contains the rules pertaining to exploratory borings (metallic minerals, petroleum, kaolin apatite, diamonds, graphite, and gemstone exploration drilling). Copies of Minnesota Rules, Chapter 4727 may be found online at [www.revisor.mn.gov/rules](http://www.revisor.mn.gov/rules) or obtained from the MDH Well Management Section.

*STAT AUTH: MS s 103I.101; 103I.111; 103I.205; 103I.221; 103I.301; 103I.401; 103I.451; 103I.501; 103I.525; 103I.531; 103I.541; 103I.621; 144.05; 144.12; 12.122; 144.383; 157.04; 157.08; 157.09; 157.13*  
*HIST: 17 SR 2773; 18 SR 1222; 33 SR 211*

### **4725.2020 INTERCONNECTION OF AQUIFERS PROHIBITED.**

*Subpart 1. Aquifer interconnections. A well or boring must not be constructed to interconnect aquifers separated by a confining layer or interconnect an unconsolidated aquifer and a bedrock aquifer.*

***Subpart 1a. Open bore hole, gravel pack, or screen in a confining layer. A well or boring must not have open bore hole, gravel pack, or screen extending through more than:***

***A. ten feet of a confining layer, except for the Decorah or Glenwood formations;***

***B. two feet of the Decorah or Glenwood formations; and***

***C. 50 percent of the confining layer.***

***The commissioner may establish less stringent standards than identified in this subpart where protective conditions exist or unique characteristics of the confining layer exist, including low permeability overlying materials, favorable groundwater gradients, the presence of fractures or permeable horizons in the confining layer, or reduced contaminant loading in recharge areas. The areas subject to less stringent standards under this provision will be designated on a map published by the commissioner, along with the standards that do apply to those areas.***

***Subp. 2. [Repealed, 33 SR 211]***

***Subp. 3. [Repealed, 33 SR 211]***

A “confining layer” means a stratum of a geologic material that restricts vertical water movement. A confining layer includes: (A) a stratum at least 10 feet in vertical thickness of unconsolidated materials or bedrock that has a vertical hydraulic conductivity of  $10^{-6}$  (0.000001) centimeters per second or less; (B) a stratum at least 10 feet in vertical thickness of clay, sandy clay, or silty clay as defined by the United States Department of Agriculture in Handbook 18; or (C) a stratum at least 10 feet in vertical thickness of the St. Lawrence or Eau Claire sedimentary bedrock formation, or a stratum at least 2 feet in vertical thickness of the Decorah or Glenwood sedimentary bedrock formation, as described in “Geology of Minnesota: A Centennial Volume “ by Sims P. K. and Morey, G.B., pages 459-473, “Paleozoic Lithostratigraphy of Southeastern Minnesota” by George Austin, which is incorporated by reference. The publication is available at the Minnesota Geological Survey, MDH, or through the Minitex interlibrary loan program. Water level or piezometric surface differences, water quality differences, and groundwater age dating are other measurements that can be used to identify and define confining layers.

The preferred method of constructing a well or boring through a confining layer is to drive or grout an outer casing into the confining layer, drill open hole through the confining layer, install an inner casing through the confining layer, and fill the annular space with grout. The rules allow a casing to be driven through a confining layer in unconsolidated formations. The rules also allow the drilling of a rotary bore hole through a bedrock or unconsolidated confining layer if casing is placed and grouted through it.

Clay, silty clay, or sandy clay are the most common confining materials in unconsolidated formations (glacial drift). Confining layers in unconsolidated materials must be sealed by driving casing through it, by filling the annular space with bentonite grout, cement-sand grout, or neat-cement grout, or by filling the annular space below a depth of 50 feet with drill cuttings (except for monitoring wells and cased environmental bore holes where grout is required). *The use of cuttings is not recommended due to bridging concerns and concerns about the confidence of their placement at depths greater than 50 feet.* Neat-cement grout, cement-sand grout, or bentonite grout is recommended in unconsolidated formations.

Shale, siltstone, or layers of sandstone and shale or siltstone are the most common confining materials in bedrock formations. Casings that are installed through a bedrock confining layer must be installed in a bore hole 3.0 inches larger than the outer diameter of the casing/coupling (except for casings deeper than 100 feet and larger than 12 inches where a 3.5-inch bigger hole is required) and the annular space must be grouted with neat-cement grout or cement-sand grout.

The basal St. Peter sandstone formation contains sufficient shale to act as a confining layer in parts of southeastern Minnesota; particularly in the seven-county twin cities area. In general, and especially where characteristics of a confining layer occur, the MDH recommends that wells not interconnect the St. Peter and Prairie du Chien formations, and that annular spaces through the basal St. Peter be filled with neat-cement grout.

Dakota County Environmental Services delegated well program has studied the characteristics of the Prairie du Chien (Shakopee and Oneota formations) and the Jordan formation. They have observed enough differences of water quality, water level, and water transmission to consider the Shakopee formation to be hydraulically separated from the Jordan formation by the Oneota. The Dakota County well program does not allow interconnection of the Shakopee and Jordan. For more information contact the Dakota County Environmental Services Department.

This rule allows an open hole or screen to penetrate no more than 50 percent of a confining layer, not to exceed 10 feet. In the Decorah and Glenwood formations, the open hole or screen may penetrate no more than 50 percent of the confining layer, not to exceed 2 feet. This is largely designed to accommodate monitoring and other investigative purposes. The intent should not be to design water-supply wells to pump water from confining layers.

Wells and borings may only be open to **one** aquifer. Open bore holes, well screens, nonwatertight casing, or gravel packs may not be placed across a confining layer. Well screens may not be placed in two different aquifers separated by a confining layer. Confining layers may be saturated and may produce limited quantities of water but still function as confining layers.

Interconnection of two or more wells or borings completed in different aquifers through piping manifolds or other means is prohibited and is discussed in Minnesota Rules, part 4725.3350

The provisions of this part do not apply if the commissioner of health has published a map detailing different construction standards from those contained in this rule part.

In the mid-1990s, in response to issues raised by drilling contractors about identifying the St. Lawrence formation and its confining properties in southern Minnesota, the MDH and the Minnesota Geological Survey conducted a study to determine where the St. Lawrence formation was present, and where it serves as a confining layer. In 1996, the MDH (i.e., the commissioner) released a well construction map directing well and boring contractors how to construct wells that encountered the St. Lawrence formation in parts of Scott, Le Sueur, Blue Earth, Nicollet, and Sibley Counties in southern Minnesota. The map is entitled "***MDH, St. Lawrence Project, Well Construction Plate, March 22, 1996.***" The map depicts where the St. Lawrence formation is absent, where it is present as the first bedrock formation encountered while drilling, and where it is present and covered by younger bedrock formations. The map directs well and boring contractors how to construct wells and borings into, or through the St. Lawrence formation. Copies of the map are available from the MDH Well Management Section. A similar study with accompanying maps is being completed in the metropolitan twin cities area.

A geologic column of southeastern Minnesota is included in the appendix.

*STAT AUTH: MS s 103I.101; 103I.111; 103I.205; 103I.221; 103I.301; 103I.401; 103I.451; 103I.501; 103I.525; 103I.531; 103I.541; 103I.621; 144.05; 144.12; 144.122; 144.383; 157.04; 157.08; 157.09; 157.13*  
*HIST: 17 SR 2773; 18 SR 1222; 33 SR 211*

## Proper Construction Into a Confining Layer

## Proper Construction Below a Confining Layer

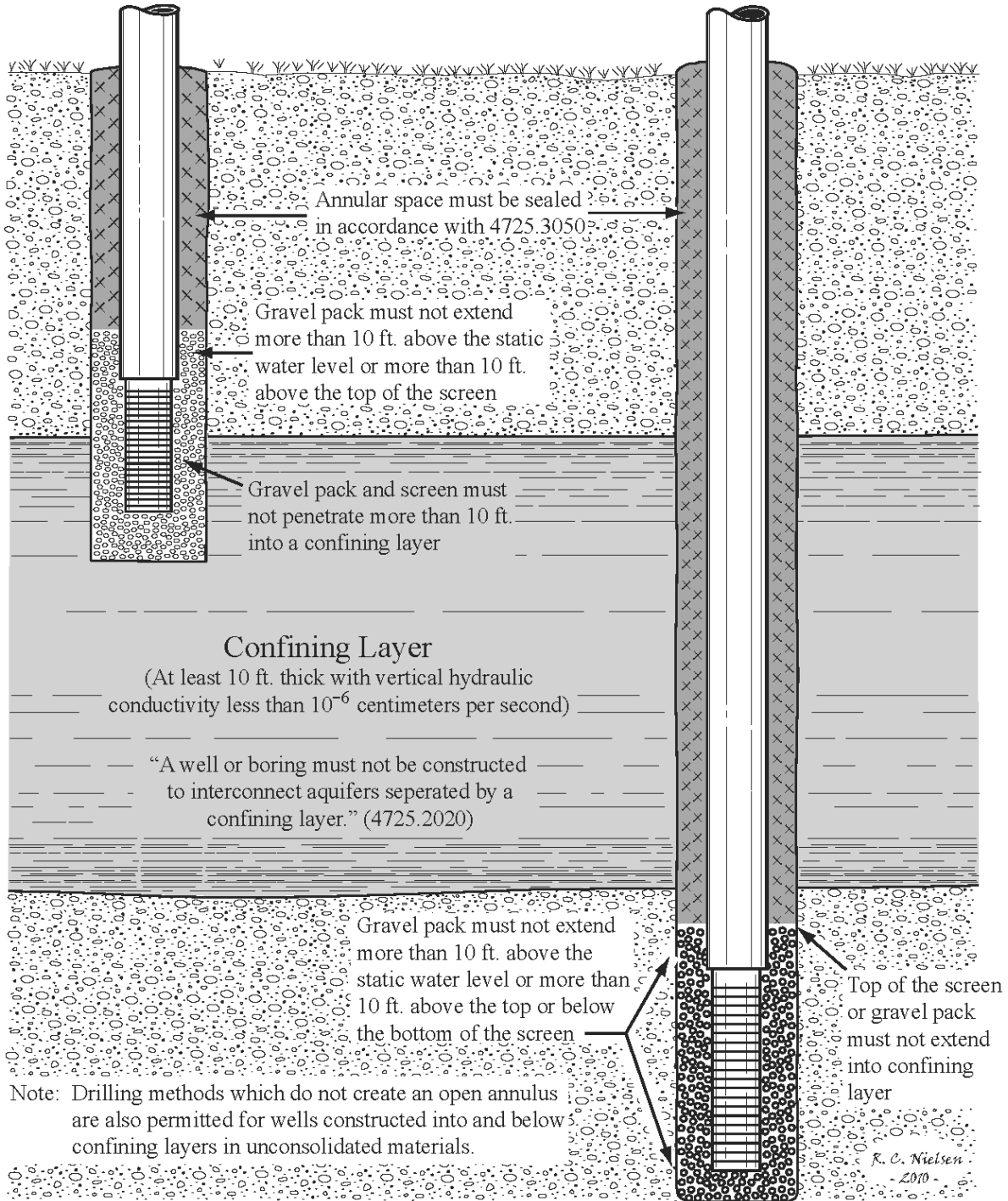

Figure 10. Proper Construction Into and Below Confining Layers in Unconsolidated Materials



Rotary Drilled, Jetted, or Augered - Steel Casing

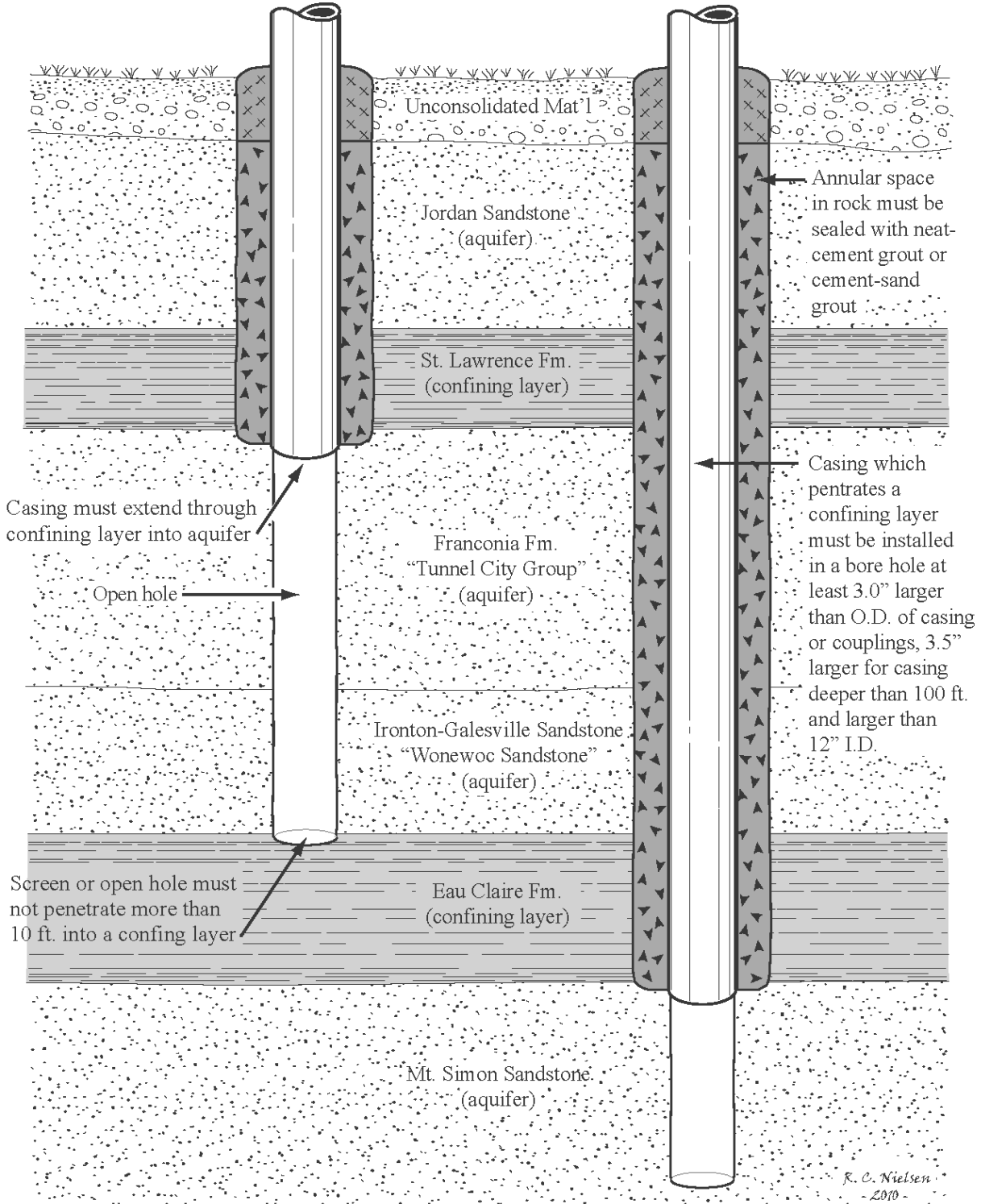

Figure 11. Proper Construction Into and Below Confining Layers in Bedrock

**4725.2050 USE OF WELLS OR BORINGS FOR DISPOSAL OR INJECTION PROHIBITED.**

*A well or boring must not be used for disposal or injection of surface water, groundwater, or any other liquid, gas, or chemical, except for groundwater thermal exchange devices, drilling fluids, vertical turbine prelubrication water, treatment chemicals, priming water, water used for hydrofracturing, and water used for disinfection in accordance with parts 4725.1831, 4725.2950, 4725.3250, 4725.3725, 4725.5050, 4725.5475, and 4725.5550. This does not prohibit the injection of air for drilling, development, or sparging.*

Disposal or injection of wastes is primarily regulated by the MPCA. Rules of the MPCA, Minnesota Rules, part 7060.0600, specifically prohibit the discharge of sewage, industrial wastes, or other wastes into the zone of saturation through wells. Chapter 7060 may be viewed at [www.revisor.mn.gov/rules](http://www.revisor.mn.gov/rules).

The well and boring rules prohibit **injection wells and borings**. A well or boring may not be used to inject surface water, groundwater, water from roof drains or other rainwater collection systems, agricultural drainage, chemicals, or wastes into an aquifer. The injection of **dye-tracing** chemicals, nutrients, organisms, or other materials for groundwater contamination remediation in a well or boring is also prohibited by this rule part; however, a variance may be granted for these purposes in certain circumstances.

This rule does not prohibit a person from introducing water into a well or boring for drilling operations, disinfection, hydrofracturing, development, slug tests, inspections, repair operations, or for permitted groundwater thermal exchange devices. This rule also does not prohibit a person from introducing approved **treatment chemicals** like chlorine or acid into a well or boring for development, repair, or rehabilitation.

*A. Water used to cool parts of engines, air compressors or other equipment, or air conditioning equipment must not be returned to a well or any part of a potable water system except if permitted as a groundwater thermal exchange device under part 4725.1831 and Minnesota Statutes, section 1031.621.*

A groundwater thermal exchange device is an installation that pumps groundwater from a supply well through a heat exchanger and then returns the water to the aquifer via a well, called an injection well. Minnesota Rules, part 4725.1831, details the permit process and the piping requirements. The water must not come in contact with hazardous materials and must be clean when returned to the aquifer.

*B. A well may be used for the injection of water to conduct a slug test if the injected water was originally taken from that well or is potable water.*

A **slug test** measures the response of an aquifer when a volume of water is either added to, or removed from, a well. The information generated is used to determine the hydraulic conductivity of the aquifer.

*STAT AUTH: MS s 103I.101; 103I.111; 103I.205; 103I.221; 103I.301; 103I.401; 103I.451; 103I.501; 103I.525; 103I.531; 103I.541; 103I.621; 144.05; 144.12; 144.122; 144.383; 157.04; 157.08; 157.09; 157.13*

*HIST: 17 SR 2773; 18 SR 1222; 33 SR 211*

**4725.2100** [*Repealed, 17 SR 2773*]

## **4725.2150 REQUIRED DISTANCE FROM GAS PIPES, LIQUID PROPANE TANKS, AND ELECTRIC LINES.**

*Subpart 1. General distances. The minimum isolation distances in item A or B must be maintained during construction, repair, or sealing of a well or boring, and installation of a pipe with flammable or volatile gas, an overhead or underground electric transmission, distribution, service, supply, feeder, branch, or conductor line hereinafter called "electric line" or "line", or a liquid propane tank. The distances are measured horizontally from the closest part of the well or boring to the closest part of the pipe, tank, or line; or closest part of the vertical projection on the earth of an overhead or buried pipe, tank, or line. The minimum isolation distance between a well or boring and a pipe with flammable or volatile gas, an electric line, or a liquid propane tank is:*

*A. ten feet; or*

*B. five feet if:*

*(1) the person constructing the well or boring, or the person installing the pipe, line, or tank, marks the well or boring with a permanent sign warning of the location of the electric line, liquid propane tank, or gas pipe; and;*

*(2) during construction of the well or boring:*

*(a) the electric line has been deenergized and visibly grounded, or insulating barriers not a part of, or an attachment to, the equipment or machinery have been erected to prevent physical contact with the line during well or boring construction; and*

*(b) the propane tank does not contain flammable or volatile gas.*

A pipe with flammable or volatile gas means a product in the gaseous state such as natural gas; it does not refer to (liquid) gasoline. Natural gas is the most common gas in this category, but other flammable gasses such as oxygen are also included.

The separation distance is required from aboveground and buried electric lines, gas pipes, and liquid propane (LP) tanks.

The separation distance applies to all types of new wells or borings installed near an existing utility, or a utility installed near an existing well or boring.

The distance is measured horizontally from the **vertical projection** of an overhead or underground utility onto the ground.

Deenergization does not apply when collecting a water sample; however, appropriate safety precautions should be followed.

The earth is not an insulating barrier.

An electric transmission line includes private electric service line(s) to or between a house or other building(s), but does not include electric wiring within a building.

Between July 15, 1974, and August 4, 2008, the rules required a 25-foot separation to an electric line over 50 kilovolts. This requirement was removed in August 2008. Even though it is no longer a requirement, maintaining distances greater than 10 feet may be a good idea where high voltages exist, or where other conditions such as line sag increase the potential for contact with the conductor, or where future utility or construction work is planned. As indicated later in this rule part, this rule does not exempt persons from requirements of the Occupational Safety and Health Administration (OSHA). OSHA requires a 10-foot (radial) separation between an electric line less than 50kV and the closest part of a mast. For lines over 50kV, the distance is increased 0.4 inch for each one kV over 50kV. Current OSHA standards should be consulted.

A well or boring may be drilled between 5 and 10 feet from an electric line, a gas pipe, or an LP tank if the well or boring is placarded and the safety precautions are followed. The person constructing a well or boring between 5 and 10 feet from the utility, or the person installing the utility between 5 and 10 feet from a well or boring is responsible for installing the sign. The **permanent** sign warning of the location of an electric transmission line and/or gas pipe must be constructed of a weatherproof material (i.e., plastic, steel, brass or aluminum, not paper) that will remain legible for the life of the well or boring. If the permanent sign becomes unreadable or detached from a well or boring, then the well owner must replace this sign.

### **ATTACHMENT OF PERMANENT SIGNS WARNING OF ELECTRIC AND GAS HAZARDS**

**ABOVE-GRADE** – For wells and borings completed above-grade, the permanent sign must be attached in a visible location to the well or boring outer casing, or the protective overshot casing with appropriate adhesive or with a stainless steel or metal clamp, band, or strap. The sign may also be screwed or bolted to a concrete pump pedestal. The sign should not be attached to the cap.

**AT-GRADE** – For wells and borings completed at-grade, the permanent sign must be attached to the casing with a metal strap, attached to the inside of the vault with suitable adhesives or screws, attached to the exterior of the vault with bolts, or cemented or bolted to the concrete pad surrounding the vault. The sign may not be placed into the vault without attachment, nor attached to the vault cover or cap.

*Subp. 2 [Repealed, 33 SR 211]*

*Subp. 3. **Exceptions.** Subpart 1 does not apply to:*

- A. an electrical service line for the well or boring;*
- B. a television, fiber optic, or other low voltage electric line with a voltage less than 50 volts;*
- C. a temporary liquid propane tank used during the construction, repair, or sealing of a well or boring;*
- D. an overhead electric line when the repairing or sealing of a well or boring does not involve the use of a drilling machine or hoist; or*
- E. a buried electric line or buried gas pipe when the repairing or sealing of a well or boring does not involve excavation.*

*The requirements of this part are minimum standards, and do not exempt persons from more restrictive requirements of the Occupational Health and Safety Administration.*

It is recommended that the appropriate utility company be contacted for any additional safety precautions or requirements prior to any construction, repair, or sealing work.

In summary: for gas pipes, LP tanks, and electric lines

**SEPARATION BETWEEN WELL  
OR BORING AND HAZARD**

**RESTRICTIONS**

> 10 feet	No MDH restrictions (consult OSHA regulations for additional requirements).
5 – 10 feet	Gas pipe – placard. LP tank – placard, remove gas or move tank during well or boring construction. Electric line – placard and either deenergize and ground, or install insulating barriers (consult OSHA regulations for additional requirements).
< 5 feet	Not permitted.

*STAT AUTH: MS s 103I.101; 103I.111; 103I.205; 103I.221; 103I.301; 103I.401; 103I.451; 103I.501; 103I.525; 103I.531; 103I.535; 103I.541; 103I.621; 144.05; 144.12; 144.383; 157.04; 157.08; 157.09; 157.13*

*HIST: 17 SR 2773; 33 SR 211*

**4725.2175 LOCATION OF WELL OR BORING WITHIN BUILDING.**

*Subpart 1. Location in a building. A well or boring must not be located within a building, and a building must not be constructed to enclose a well or boring, unless the building (well house) meets the requirements of this part. Environmental bore holes and monitoring wells are exempt from this subpart if sealed within 72 hours of the time construction begins on the well or boring.*

**A well or boring may not be constructed inside a building. A building, building addition, deck or other structure may not be built over or within 3 feet of an existing well or boring, except for a “well house,”** (see Minnesota Rules, part 4725.2185). If a well or boring is inside a building, and the building above the well or boring is torn down, burns down, or is otherwise removed, a new building may not be built over the well or boring.

The purposes of the rule are to: (1) allow for service, repair, and sealing of the well or boring including access for a drilling machine, if necessary; (2) prevent contamination due to spills and leaks inside the building which would be contained by the walls and footings of the building; (3) reduce the release of toxic (hydrogen sulfide, radon) or flammable (methane) gas into a habited or confined space; and (4) protect worker safety inside a confined area.

The “72-hour rule” applies only to monitoring wells and environmental bore holes. The time starts when drilling begins, and sealing must be completed within 72 hours.

- Subp. 2. Requirements for a building (well house) containing a well or boring.***  
***A building (well house) containing a well or boring must:***
- A. have adequate access for a drilling machine and hoist to construct, maintain, repair, and seal the well or boring;***
  - B. be constructed at or above the established ground surface. If a floor drain is installed, it must discharge to the established ground surface, a gravel pocket, or a sewer constructed to prevent backup of sewage within 50 feet of the well or boring;***
  - C. not be used to store materials or chemicals that may cause contamination of the well, boring, or groundwater, including fertilizers, pesticides, petroleum products, paints, and cleaning solvents;***
  - D. have a concrete floor sloped to divert water away from the casing;***
  - E. have a watertight gasket or caulk between the casing and the floor;***
  - F. have any door hinged to swing outward;***
  - G. be constructed according to this part exclusively to contain and protect the well, boring, pump, and water treatment equipment and water treatment chemicals; no other uses of the building are permitted; and***
  - H. not be contained in, or part of, another building, except that a well house may be constructed with not more than one wall in common with another building. The common wall must not allow access to, or be open to, the well house.***

This subpart details the requirements for buildings containing a well or boring, sometimes referred to as “well houses.”

While simple repairs and pump replacement may often be done by hand or with simple tools, some work, particularly extensive repairs or sealing may require a full-sized drilling machine.

Refer to Minnesota Rules, part 4725.3150 for information regarding connections to a casing.

Caulk may be silicone or other nontoxic materials.

**Well houses** may not be below ground, or built into hillsides (walkouts). The floor of the well house must be at or above the established ground surface. Well houses may be attached to other structures, such as a lean-to built against a home or other building. Well houses may not be a building or room enclosed within another building.

**Floor drains** in well houses are not recommended. A floor drain must be constructed to prevent backup or flooding of the well house. This can be accomplished by use of an air gap as detailed in the Minnesota Plumbing Code, Chapter 4715. A well house must not have toilets, sinks, or other plumbing fixtures.

**Water treatment chemicals** such as chlorine or polyphosphate may be stored in a well house. A well house for a remedial well may enclose the well and remediation equipment, including water treatment equipment, water treatment chemicals, and remediation product tanks, subject to appropriate backflow prevention.

*Subp. 3. Requirements for a well or boring inside a building. A well or boring located in a separate building (well house) must:*

*A. have casing extending at least 12 inches above the established ground surface, and at least 12 inches above the building floor; and*

*B. be located according to part 4725.2185, except that this does not apply to a removable well house.*

The preceding subpart (2) detailed the requirements for the well house, this subpart details requirements for a well or boring within a well house.

Minnesota Rules, part 4725.2185 requires the well or boring to be at least 3 feet from a wall. A well or boring in a well house is not required to be 3 feet from the walls of the well house except for the common wall of a building if the well house is a “lean-to” on the side of a building.

*STAT AUTH: MS s 103I.101; 103I.111; 103I.205; 103I.221; 103I.301; 103I.401; 103I.451; 103I.501; 103I.525; 103I.531; 103I.535; 103I.541; 103I.621; 144.05; 144.12; 144.383; 157.04; 157.08; 157.09; 157.13*

*HIST: 17 SR 2773; 33 SR 211*



### **4725.2185 DISTANCE FROM A BUILDING.**

*A minimum horizontal isolation distance of three feet must be maintained between a well or boring and the farthest exterior projection of a building, including the walls, roofs, decks, overhangs, and other permanent structures unless the well or boring is located in a building constructed according to part 4725.2175. A building, deck, or other permanent structure, except a well house, must not be built to enclose a well or boring. The well or boring must be accessible for repair and sealing. Environmental bore holes and monitoring wells are exempt from this subpart if sealed within 72 hours of the time construction begins on the well or boring.*

A minimum 3-foot horizontal separation distance must be maintained between a well or boring and the furthest projection of any building or structure. Building projections include roof overhangs and gutters and any attachments to a building including, but not limited to, additions, steps, canopies, porches, or decks. The 3-foot distance is measured from the outermost portion of the well or boring, including the vertical projection of the well or boring, to the closest part of the building, building projection, or structure. Buildings, building projections, or other structures may not be built over the top of a well or boring, and may not be built to surround a well or boring.

Clear access must be provided so that a well drilling machine and hoist may back up to the well or boring to perform maintenance, repair, and permanent sealing.

If a well or boring is located inside a building and the building is torn down or otherwise removed, a new building may not be constructed over the well or boring.

*STAT AUTH: MS s 103I.101; 103I.111; 103I.205; 103I.221; 103I.301; 103I.401; 103I.451; 103I.501; 103I.525; 103I.531; 103I.535; 103I.541; 103I.621; 144.05; 144.12; 144.383; 157.04; 157.08; 157.09; 157.13*  
*HIST: 17 SR 2773; 33 SR 211*

**4725.2200 [Repealed, 17 SR 2773]**

## **4725.2250 GENERAL CASING REQUIREMENTS.**

- Subpart 1. Casing types. Permanent casing installed in a well or boring must be:*
- A. steel casing as specified in part 4725.2350;*
  - B. stainless steel casing as specified in part 4725.6650 when used for a monitoring well, environmental bore hole, or remedial well;*
  - C. flush threaded polyvinyl chloride casing as specified in part 4725.6650 when used for a monitoring well or environmental bore hole; or*
  - D. plastic casing as specified in part 4725.2550.*

Only two casing materials are allowed for use in all wells and borings: a minimum Schedule 40 (casings 10-inches and smaller) or standard weight (casings greater than 10 inches) steel pipe; and a minimum SDR 21, 200 psi rated, solvent-welded plastic pipe. Monitoring wells and environmental bore holes may be cased with flush-threaded casing (in addition to the other two types of casing) under certain conditions. Monitoring wells, environmental bore holes, and remedial wells may be cased with stainless steel. Dug water-supply wells must have standard casing; however, variances may be granted for larger diameter casing made of other materials in some circumstances. The specifications and requirements for flush-joint casing and stainless steel casing are located in Minnesota Rules, part 4725.6650. Certain exemptions exist for temporary casing, outer casings, casings for flowing wells, and dewatering wells.

*Subp. 2. Watertight casing required. All casing couplings and casing joints must be watertight throughout their lengths. Casing must not have holes, cracks, or separations.*

Casing which has been slotted or perforated for use as a screen, is no longer considered to be casing, and must meet the requirements and restrictions for screens.

*Subp. 2a. Casing joints. All casing joints must be watertight, with threaded, welded, or solvent welded joints, and comply with the standards in part 4725.2350, 4725.2550, or 4725.6650.*

*A. Threaded joints must have recessed couplings, reamed and drifted couplings, or other couplings that match the design, taper, and thread type of the casing. Thread must not be exposed on the pipe when the casing is joined.*

*B. Welded casing, except where an approved welding coupling is used, must have beveled joints. The weld must extend the full circumference of the casing and must completely fill the bevel.*

*C. Welding couplings must be made of material equivalent to the casing. The upper and lower welds must extend the full circumference of the casing, and completely fill the gap between the coupling and casing. Welding the casing to the inside of the coupling is prohibited.*

The only **acceptable casing joints** are threaded, welded, or solvent welded (“glued”). Other types of joints such as splined, compression, compression gasket (Dresser coupling), slip, or cam-lock are not approved except for some special casing connections as specified in Minnesota Rules, parts 4725.3350

and 4725.4850. Different casing types or materials may not be used in the same casing string unless the connection meets the criteria for both types of casing. As an example, a piece of threaded Schedule 40 steel casing may not be butt-welded to a piece of plain-end casing.

Welding rings or couplings that slip over both ends at a steel casing joint are allowed subject to the conditions in item “C” above.

The use of plastic slip X slip couplings to join plastic casing to steel casing by friction fitting or gluing the steel casing in the plastic fitting is not approved.

**Recessed** couplings have a shoulder or unthreaded lip which covers the pipe threads.

“**Reamed and drifted**” refers to the process of facing the end of the pipe to remove burrs and bevel the end, and pushing a mandrel through the casing to maintain a minimum diameter. The term “reamed and drifted coupling” refers to recessed couplings designed for use with reamed and drifted casing meeting the ASTM A589 standard.

The threaded ends of the casing must be covered by the coupling when the pipe and coupling are made up. “Standard” depth or “**merchant**” couplings are not approved.

*Subp. 3. **New casing required.** Casing used in the permanent construction of a well or boring must be new casing produced to the specifications of this rule part. Casing salvaged from the same type of well or boring within 120 days of installation is acceptable for reuse if it meets the specifications for new casing. A potable water well must be constructed with new casing or casing salvaged from a potable water well.*

The specifications referred to are the requirements of this rule.

“**Casing salvaged**” means that casing has been removed from an unsuccessful or temporary well or boring within 120 days of installation.

“**New casing**” means that the casing has not been used for well pipe, or for any other purpose. If a potable water-supply well is cased with used casing, it must have been salvaged within 120 days of its installation in a potable water well. If casing markings are unreadable on salvaged casing, the contractor may be required to verify that the casing meets the specifications by laboratory testing.

*Subp. 4. **Casing markings required.** Steel and plastic permanent casing except flush-threaded PVC and stainless steel casing must be marked by the manufacturer in accordance with casing specifications in parts 4725.2350 to 4725.2550. Markings must be rolled, stamped, or stenciled by the manufacturer.*

The rules require casing to be **marked by the manufacturer**, that is, the original producing mill. However, if an end finisher has the legal right from a mill to mark casing, the mill documents this in writing, and documents that the casing meets the ASTM or API standard, the pipe may be accepted.

If pipe appears not to meet the standard, the pipe will be rejected unless it is proven to the satisfaction of the MDH or delegated well program that the pipe meets the standard by providing valid mill papers and/or conducting testing by an independent testing lab. The costs of the testing are the responsibility of the person wanting to use the pipe.

The ASTM and API standards require different markings for different types of casing. The marking requirements are explained in the annotation after each material specification (Minnesota Rules, parts 4725.2350 to 4725.2550).

***Subp. 5. Casing testing.*** *Casing rejected by the manufacturer must not be used. The commissioner may require that casing be submitted to an independent testing agency to evaluate if it meets or exceeds specifications when the casing:*

Some casing manufacturers mark white or yellow circumferential bands on casing to indicate reject pipe. However, the presence of painted bands does not always indicate that the pipe is reject.

- A. lacks markings or has illegible or altered markings;*
- B. contains pits, cracks, patches, partial welds, bends, or other manufacturing defects; or*
- C. lacks mill certification papers from the original manufacturer.*

***Subp. 6. Casing rejection.*** *The commissioner shall reject casing for use in a well or boring if:*

- A. the casing is not submitted for evaluation and verification when required by the commissioner;*

This refers to testing by an independent laboratory. The cost of testing the casing is the responsibility of the person who wishes to use the casing.

- B. the casing fails to meet the specifications in part 4725.2350, 4725.2550, or 4725.6650; or*
- C. the lot of casing contains defective lengths, including casing with girth-welded joints, or welded patches, or the lot has more than five percent of the casings with lengths less than five feet.*

***Subp. 7. Temporary casing.*** *Casing installed temporarily during drilling is not required to meet the specifications for casing in parts 4725.2350, 4725.2550, 4725.6650, or this part except subparts 2, 7, and 16, but must be of sufficient strength to withstand the structural load imposed by conditions both inside and outside the well or boring, and free of oil or other contaminants. The casing must be removed on completion of the well or boring.*

Subpart 2 requires watertight casing, and subpart 16 requires a cap or cover.

This does not refer to “**surface casing**” or other pipe which is left in the ground. This only refers to casing which is removed before the well or boring is completed.

Temporary plastic casing may be drilled through, however permanent plastic casing may not (Minnesota Rules, part 4725.2650, subpart 8).

Temporary driven casing is not required to have a drive shoe.

Be aware that casing must not be removed and the hole allowed to collapse. A well or boring must be sealed, or an annular space grouted, by pumping grout through a tremie pipe or the casing from the bottom up. Casing can only be removed prior to grouting in a noncollapsing formation. If the formation will collapse, the grout must be inserted before removing the casing.

If casing is not removed from the hole, it must meet the standards for permanent casing except as detailed in subpart 9 below.

***Subp. 8. Inner and outer casing. The inside diameter of an outer casing must be at least 3.0 inches larger than the outside diameter of the inner casing, couplings, or bell-end, whichever is larger, except that the inside diameter of an outer casing must be at least 3.5 inches larger than the outside diameter of the inner casing, couplings, or bell end, whichever is larger, for inner casings deeper than 100 feet and larger than 12 inches inside diameter. The annular space between an inner casing and an outer casing must be grouted for its entire length by pumping neat-cement grout or cement-sand grout through a tremie pipe or through the casing as specified in part 4725.3050. The inner casing must extend above the established ground surface at least 12 inches.***

This rule is designed to prevent the flow of contaminants or water in the annular space between casings. The minimum annular space requirements are designed to allow sufficient space to grout with a tremie pipe. Even though grouting through the casing is allowed, in certain circumstances it becomes necessary to use a tremie pipe.

This rule formerly only allowed neat-cement grout between casings, now cement-sand grout is also allowed.

The rule applies to all permanent casings including surface casings, “pit pipe” or “starter pipe” which are not removed, liners, and protective casings. It does not apply to a screen leader pipe as defined in Minnesota Rules, part 4725.0100, subpart 41h, or regulated in Minnesota Rules, part 4725.2750.

This rule requires that the **annular space between multiple casings** be entirely grouted with neat-cement or cement-sand grout. Telescoped casing is prohibited. All casings must extend above the surface except when a pitless is used, in which case the outer casing(s) may terminate immediately below the pitless. All inner and outer casing combinations must meet the annular space requirements of this rule part.

For plain-end pipe, the smallest outer casing allowed is calculated by adding 3.0 inches to the outside diameter of the inner casing. This number represents the minimum inside diameter of the outer casing. If the inner casing is centered inside the outer casing, there will be 1.5 inches of grout between the casing. For threaded and coupled, or bell-end casing, the smallest outer casing allowed is calculated by adding

3.0 inches to the outside diameter of the coupling or bell end. If the inner casing is centered inside the outer casing, there will be 1.5 inches of grout between the outer casing ID and the couplings or bell ends. If the inner casing is larger than 12 inches ID and is deeper than 100 feet, 3.5 inches, instead of 3.0 inches, is used. This will result in 1.75 inches of grout between centralized casings.

A table of common inner and outer casing combinations allowed by rule is included in the appendix.

The use of casing **centralizers** is no longer required. However, the use is permitted and generally encouraged to further assure a competent seal and protect the casing from corrosion. Centralizers allow for even placement of grout, but may interfere with insertion and removal of a tremie pipe.

***Subp. 9. Outer casing in unconsolidated materials. A permanent outer steel casing installed in unconsolidated materials is not required to meet the requirements of this part except subparts 2, 9, and 17, or the material specifications for casing in part 4725.2350 if the casing is of sufficient strength to withstand the structural load imposed by conditions both inside and outside the well or boring, the casing is free of oil or other contaminants, an inner casing meeting the requirements of this chapter is installed, and the annular space between the casings is filled with neat-cement grout, or cement-sand grout. The outer casing must be installed in accordance with part 4725.3050 subpart 3 or 5.***

This allows the use of permanent outer steel casing that does not meet the weight, thickness, or material standard requirements of rule. Plastic casing is not allowed since it may not be drilled through (Minnesota Rules, part 4725.2650, subpart 8). It is the contractor's responsibility to grout the space between the outer and inner casing with neat-cement or cement-sand grout. The outside of the outer casing installed in unconsolidated material must also be grouted (at least the top 50 feet, with the lower portion filled with grout or cuttings) if installed by rotary or other methods which creates an annular space. If the lightweight outer casing fails during installation or cannot be grouted, it is the contractor's responsibility to correct the well or boring, including perforation, casing removal, or sealing if necessary.

***Subp. 10. Casing inside diameter. The inside diameter of a permanent casing must not be less than two inches for a well or boring greater than 50 feet in depth.***

The 50-foot depth refers to the total depth of the well or boring, not the depth of the casing.

The rule is intended to allow sufficient space to perform maintenance; remove obstructions, test devices, or pumping equipment prior to sealing; and properly seal the well or boring.

A well or boring less than 50 feet deep has no minimum casing diameter. However, access into the casing for maintenance, repair, or sealing may be difficult. Ultimately the well or boring must be properly sealed, which may require drilling out the casing if a grout pipe cannot be inserted.

***Subp. 11. Casing height. A casing or casing extension must extend vertically at least 12 inches above the established ground surface, the floor of a building (well house) as specified in part 4725.2175, or a concrete slab, except that the casing for a hand pump may terminate a minimum of 6 inches above a concrete slab in accordance with part 4725.3250, item A, if the concrete slab is at least 6 inches***

*above the established ground surface. The established ground surface, slab, or floor immediately adjacent to the casing must be graded to divert water away from the casing. Termination of the top of the casing below the established ground surface, such as in a well pit, is prohibited except that an outer casing may terminate immediately below a pitless adapter installed on an inner casing.*

All casings, except outer casings when a pitless is installed, or approved at-grade wells or borings, must terminate a minimum of 12 inches above the established ground surface. The established ground surface is the elevation of the actual or finished grade, whichever is higher. The ground or slab must be sloped so that rain, surface water, spills, or floods run away from the well. If possible, the ground should slope away from the casing in all directions.

***Subp. 12. Casing offsets. Casing offsets are prohibited.***

A “casing offset” means that a fitting or bend in the casing deviates the casing from being plumb and aligned.

***Subp. 13. Multiple casings. Except for inner and outer casings installed in accordance with subpart 8, multiple casings must not be installed in a single bore hole.***

The rules require a casing to be surrounded with grout, cuttings in unconsolidated formations below 50 feet, or undisturbed formation in the case of driven casings. The practice of installing multiple casings in a single bore hole with gravel pack surrounding screened intervals set at different depths does not meet the standards of the rules. Each casing must be in a separate bore hole.

***Subp. 14. Casing reduction and enlargement. A casing must maintain the same inside diameter throughout the length of the casing, except that a larger diameter pitless unit may be installed.***

A casing must maintain the same inside diameter throughout the length of the well or boring and terminate a minimum of 12 inches above-grade. It is not permissible to reduce or enlarge a casing, such as connecting a 4-inch casing to a 4-1/2-inch casing, or other configuration. The only exceptions are that the upper casing extension from the pitless to the surface may be increased in size. A “buried slab” construction of installing a small diameter upper casing and pitless on a large diameter dug well is not approved.

***Subp. 15. Casing drive shoes. A drive shoe must be installed on driven casing except for a drive point casing, temporary casing, or outer casing that has a neat-cement or cement-sand grouted inner casing. The drive shoe must:***

- A. be made of steel or iron, with a hardened, beveled cutting edge;***
- B. have a wall thickness equal to or larger than the casing thickness, and***
- C. be threaded or welded to the bottom of the casing.***

Use of a quality drive shoe can result in a good seal into rock, and may eliminate sand pumping and crooked or bent casing.

### DRIVE SHOE REQUIREMENTS

- A coupling is not a drive shoe;
- Heat tempering the casing is not a drive shoe;
- A drive shoe must be as hard as the casing;
- A drive shoe may be commercially purchased or shop made; and
- Either a regular cable tool style or rotary style shoe (inner bevel versus outer bevel) is allowed.

### DRIVE SHOE RECOMMENDATIONS

The rule does not have a minimum numerical standard for hardness, tensile strength, yield, bevel, or length. However, it is recommended that a drive shoe have a:

- Rockwell C hardness of 50 or greater;
- Minimum 45,000 psi tensile strength;
- Minimum 25,000 yield strength;
- 30 degree bevel with a 1/16th inch face; and
- Length at least as long as the casing diameter up to 12 inches.

***Subp. 16. Temporary cap or cover required. Until a well or boring is completed and a permanent cap or cover installed, the installer must temporarily cap or cover the bore hole, casing, and annular space of a well or boring when not actively working on the well or boring, in accordance with subpart 17, or install a weatherproof, tamper-proof cover. An overlapping steel plate is permitted. Tape, pails, loose plastic, or similar covers are not permitted.***

**The casing must be temporarily covered during the construction** process at times when actual work on the well or boring is not occurring. The purpose is to prevent accidents such as children or animals from falling in the hole, and to prevent surface contaminants from entering the well. In addition, the cover will help prevent vandalism, and hole collapse should a large rain occur. Plastic pails, boards, or other nonweatherproof covers are not allowed. In addition to the permanent caps and covers listed in rule subpart 17, an overlapping metal plate may be placed over the casing, with the drill rods or drill string used to hold the plate down.

An **uncased hole** must be covered during the construction process at times when actual work on the well or boring is not occurring. A pit pipe covered with a cap or well seal may be used. The mud box may be placed over the bore hole. An overlapping, competent metal plate or wood cover may be placed over the uncased bore hole held down with the drill rods, or other heavy weight.

***Subp. 17. Permanent cap or cover required. A permanent watertight and vermin-proof cap or cover must be installed on the inner casing of a well or boring. The cap or cover must be constructed of metal or plastic materials having a thickness comparable to the casing requirements specified in subpart 1. The cap or cover must consist of:***

- A. an overlapping cover or cap;***
- B. a threaded plug, cover, or plate;***
- C. a welded or solvent welded overlapping plate or cover;***
- D. an extension of the casing at least 1 inch into the base of a power pump; or***



*E. a sanitary seal or plug with a one-piece top plate, compression gasket, and noncorrodible draw bolt(s). If the well or boring is in a building that meets the requirements in part 4725.2175, a two-piece top plate, compression gasket, and noncorrodible draw bolts may be used.*

Caps must be constructed of materials comparable to the casing material standards.

See the comments after Minnesota Rules, part 4725.3150 for the details of pumps mounted on top of a casing. The casing must extend at least 1 inch into the base of the pump. The casing must terminate at least 12 inches above-grade or above a well-house floor.

The weatherproof and insect proof requirement applies to any connection through the cap or sanitary seal including discharge connections, air lines, or electrical connections. Special emphasis should be placed on electrical wires, see Minnesota Rules, part 4725.3150, subpart 3. Electrical wires must be sealed with a compression gasket or other seal.

*STAT AUTH: MS s 103I.101; 103I.111; 103I.205; 103I.221; 103I.301; 103I.401; 103I.451; 103I.501; 103I.525; 103I.531; 103I.535; 103I.541; 103I.621; 144.05; 144.12; 144.383; 157.04; 157.08; 157.09; 157.13*  
*HIST: 17 SR 2773; 33 SR 211*

*4725.2300 [Repealed 17 SR 2773]*

### **4725.2350 STEEL CASING REQUIREMENTS.**

*Subpart 1. General. Steel casing used in the permanent construction of a well or boring must be new casing produced to:*

- A. ASTM Standard A53/A53M-04a;*
- B. ASTM Standard A589-96 (2001), Types I, II, and III; or*
- C. API Standard 5L-04.*

*Steel casing must have the minimum weights and thicknesses specified in the table in subpart 2 subject to the tolerances in the specifications in this subpart.*

The ASTM and API standards in subpart 1 contain criteria for such things as tensile strength, chemical composition, and other characteristics of the pipe. Within the standards are numerous grades and weights of pipe. Steel casing must meet the requirements of subpart 2 (Schedule 40 for casing 10 inches and smaller, standard weight for casing larger than 10 inches) and one of the ASTM or API standards (ASTM A53, ASTM A589, or API 5L). Subpart 2 details minimum wall thicknesses and standards for threads and couplings.

Subpart 2 establishes nominal casing weight per foot and wall thickness for Schedule 40 and standard weight steel pipe. Schedule 80 or heavier pipe is also acceptable. The ASTM and API standards allow wall tolerance to vary from the nominal value in both the positive (thicker wall) and negative (thinner wall). The minimum wall is - 12.5 percent under the nominal wall except for API pipe larger than 20 inch (which is -10 percent).

The appendix contains an American National Standards Institute (ANSI) pipe schedule table.

Casing must be marked by the mill (or an approved process or end finisher, see below) in accordance with the A53, A589, or 5L marking requirements.

**REQUIRED MARKINGS ON STEEL CASING ACCORDING TO AMERICAN SOCIETY FOR TESTING AND MATERIALS (ASTM) AND AMERICAN PETROLEUM INSTITUTE (API) STANDARDS:**

**American Society for Testing and Materials (ASTM) STANDARD  
A53M-04**

Each length of pipe shall be legibly marked by rolling, stamping, or stenciling with the following information:

1. The name or brand of the manufacturer;
2. The kind of pipe, continuous welded, electric-resistance welded A, electric-resistance-welded B, seamless A; or seamless B; XS for extra strong, XXS for double extra strong;
3. The specification number;
4. The length in feet and tenths of a foot or meters to two decimal places;
5. When requested by the purchaser, Type S (seamless) and Type E (electric resistance welded) pipe shall also be marked with the heat number; and
6. Seamless pipe shall be marked with Test Pressure, NDE (nondestructive electric test), or Test Pressure/NDE.

For pipe with National Pipe Size (NPS) 1.5 (inches) and smaller, which is bundled, the above information may be marked on a tag securely attached to each bundle.

**NOTE: The ASTM standard allows a processor to transfer markings on pipe which has been cut into shorter lengths if all the information is transferred and if the name of the processor is added. Minnesota rules, however, require that the marking be done by the manufacturer. The MDH will allow a processor or end finisher to remark casing only if the manufacturer (original producing mill) documents in writing that the casing meets the specification, and that the processor has the right to mark the casing.**

**American Society for Testing and Materials (ASTM)  
Standard A589-96 (2001), Types I, II, and III**

Each length of pipe shall be legibly marked by rolling, stamping, or stenciling with the following information:

1. The name or brand of the manufacturer;
2. Type number;
3. The kind of pipe (butt-welded, electric-resistance-welded, or seamless);
4. Grade;
5. Nominal or outside diameter size;
6. Wall thickness; and
7. The specification number and length (length shall be marked in feet and tenths of a foot or meters to two decimal places).

Markings shall begin approximately 12 inches from the coupling of each length. Type II pipe NPS 1.5 and under and for all sizes of Type III pipe, the required markings as specified above may be applied to a tag securely attached to the bundle or bale prepared for shipping.

**NOTE:** The ASTM standard allows a processor to transfer markings on pipe which has been cut into shorter lengths if all the information is transferred and if the name of the processor is added. Minnesota Rules, however, require that the marking be done by the manufacturer. The MDH will allow a processor or end finisher to remark casing only if the manufacturer (original producing mill) documents in writing that the casing meets the specification, and that the processor has the right to mark the casing.

### **American Petroleum Institute (API) Standard 5L-04**

Pipe manufactured in conformance with this specification, shall be marked by the manufacturer with the following information:

1. Manufacturer's name or mark;
2. Spec 5L;
3. Size in inches;
4. Weight per foot;
5. Grade (The grade specification is the actual marking for that grade, i.e. Grade A25 has the marking A25. The grades are as follows: A25, A, B, X42, X46, X52, X56, X60, X65, X70, and X80. For grades intermediate to X42 and X56, the symbol shall be X followed by the first two digits of the specified minimum yield strength. For all grades X42 and higher containing columbium, vanadium, and/or titanium, the grade symbol shall be followed by the letter(s) C, V, T or combination thereof.);
6. Process of manufacture (Symbols used are: seamless pipe (S), welded pipe which excludes butt-welded pipe (E), butt-welded pipe (F) and spiral weld pipe (SW).);
7. Type of steel (Symbols used are: electric-furnace steel (E) and rephosphorized steel class II (R). No type marking is required for open-hearth or basic-oxygen steel.);
8. Heat treatment (Symbols used are: normalized or normalized and tempered (HN), subcritical stress relieved (HS), subcritical age hardened (HA) and quench and tempered (HQ));
9. Test pressure; and
10. Length in inches and tenths of a foot.

Couplings shall be die stamped or paint stenciled and pipe shall be paint stenciled with the above-mentioned required information.

For pipe 1.900 inch O.D. and smaller, the above markings shall be die stamped on a metal tag fixed to the bundle, or may be printed on the straps or banding clips used to tie the bundle.

Seamless pipe greater than 1.900 inch O.D. and welded up to 16 inch O.D. shall be paint stenciled on the outside surface of the pipe starting at a point between 18 and 30 inches from the end of the pipe, and in the sequence as stated above, except when agreed between the purchaser and manufacturer some or all of the markings may be placed on the inside surface in a sequence convenient to the manufacturer.

Welded pipe 16-inch O.D. and larger shall be paint stenciled on the inside surface of the pipe starting at a point no less than 6 inches from the end of the pipe in a sequence convenient to the manufacturer, unless otherwise specified by the purchaser.

Subp. 2. Steel casing pipe weight and dimensions.

	Size In Inches	Plain End	Wgt. Lbs. Per Ft		Thickness In Inches	Diameter-Inches		Thrds per Inch	Couplings	
			Thrds & Cplgs.*	Thrds. R&D Cplgs.		External	Internal		Minimum External Diameter Inches	Minimum Length
S	1	1.68	1.68	1.70	.133	1.315	1.049	11-1/2	1.576	2-5/8
c	1-1/4	2.27	2.28	2.30	.140	1.660	1.380	11-1/2	1.900	2-3/4
h	1-1/2	2.72	2.73	2.75	.145	1.900	1.610	11-1/2	2.200	2-3/4
e	2	3.65	3.68	3.75	.154	2.375	2.067	11-1/2	2.750	2-7/8
d	2-1/2	5.79	5.82	5.90	.203	2.875	2.469	8	3.250	3-15/16
u	3	7.58	7.62	7.70	.216	3.500	3.068	8	4.000	4-1/16
l	3-1/2	9.11	9.20	9.25	.226	4.000	3.548	8	4.625	4-3/16
e	4	10.79	10.89	11.00	.237	4.500	4.026	8	5.200	4-5/16
	5	14.62	14.81	15.00	.258	5.563	5.047	8	6.296	4-1/2
4	6	18.97	19.18	19.45	.280	6.625	6.065	8	7.390	4-11/16
0	8	28.55	29.35		.322	8.625	7.981	8	9.625	5-1/16
	10	40.48	41.85		.365	10.750	10.020	8	11.750	5-9/16
S	12	49.56	51.15		.375	12.750	12.000	8	14.000	5-15/16
t	14	54.57	57.00		.375	14.000	13.250	8	15.000	6-3/8
a	16	62.58	65.30		.375	16.000	15.250	8	17.000	6-3/4
n	18	70.59	73.00		.375	18.000	17.250	8	19.000	7-1/8
d	20	78.60	81.00		.375	20.000	19.250	8	21.000	7-5/8
a	22	86.61			.375	22.000	21.250			
r	24	94.62			.375	24.000	23.250			
d	26	102.63			.375	26.000	25.250			
	30	118.65			.375	30.000	29.250			
W	32	126.66			.375	32.000	31.250			
G	34	134.67			.375	34.000	33.250			
T	36	142.68			.375	36.000	35.250			

\* Nominal weight based on length of 20 feet including coupling. Steel casing up to 10 inches in diameter must be Schedule 40. Larger diameter casing must be standard weight.

**Statutory Authority:** MS s 103I.101; 103I.111; 103I.205; 103I.221; 103I.301; 103I.401; 103I.451; 103I.501; 103I.525; 103I.531; 103I.535; 103I.541; 103I.621; 144.05; 144.12; 144.383; 157.04; 157.08; 157.09; 157.13

**History:** 17 SR 2773; 33 SR 211

STAT AUTH: MS s 103I.101; 103I.111; 103I.205; 103I.221; 103I.301; 103I.401; 103I.451; 103I.501; 103I.525; 103I.531; 103I.535; 103I.541; 103I.621; 144.05; 144.12; 144.383; 157.04; 157.08; 157.09; 157.13

HIST: 17 SR 2773; 33 SR 211

**4725.2400** [Repealed, 17 SR 2773]

**4725.2450** [Repealed, 33 SR 211]

The stainless steel standards formerly in this rule part are now in Minnesota Rules, part 4725.6650.

**4725.2500** [Repealed, 17 SR 2773]

**4725.2550 PLASTIC CASING AND COUPLING REQUIREMENTS.**

*Subpart 1. General requirements. Plastic casing and couplings used in the permanent construction of a well or boring must:*

*A. meet ASTM Standard F480-02, except that flush threaded polyvinyl chloride casing must not be used except for a monitoring well or environmental bore hole; and*

*B. withstand internal pressures of 200 pounds per square inch (psi). Standard dimension ratios (SDR) and water pressure ratings (PR) at 23 degrees Celsius (73 degrees Fahrenheit) for nonthreaded polyvinyl chloride (PVC) and acrylonitrile-butadiene-styrene (ABS) plastic casing equal to or greater than 200 psi are as follows:*

*(1) pressure rating of PVC casing materials:*

SDR	PVC 1120	PVC 1220	PVC 2112	PVC 2116	PVC 2120
13.5	315 psi	315 psi	200 psi	250 psi	315 psi
17	250 psi	250 psi	-	200 psi	250 psi
21	200 psi	200 psi	-	-	200 psi

*(2) pressure rating of ABS casing materials:*

SDR	ABS 1316	ABS 2112
13.5	250 psi	200 psi
17	200 psi	-

*The sources of the pressure rating in item B are the American Society for Testing and Materials Standard D2241-04a “Standard Specifications for Poly(Vinyl Chloride) (PVC) Pressure-Rated Pipe (SDR Series)” Table XI.I Standard Thermoplastic Pipe Dimension Ratios (SDR) and Water Pressure Rating (PR) at 73 degrees Fahrenheit (23 degrees Celsius) for Nonthreaded Plastic Pipe; and Standard D2282-99e “Standard Specification for Acrylonitrile-Butadiene-Styrene (ABS) Plastic Pipe (SDR-PR),” Table XI.I Standard Plastic Pipe Dimension Ratios (SDR) and Water Pressure Ratings (PR) at 73 degrees Fahrenheit (23 degrees Celsius) for Nonthreaded ABS Plastic Pipe.*

The commercially available plastic casing which meets both the F480 standard and the 200 psi requirement is SDR 21 PVC in cell class 1120/1220, with solvent-welded bell and spigot joints.

“SDR” is the ratio of the pipe diameter to the pipe wall thickness. A smaller SDR is a thicker pipe. For pipe of different sizes but the same SDR, the ratio of wall thickness to diameter remains constant. Pipes of the same SDR and same material, but different diameters, have the same pressure rating.

ABS-well casing is covered by the standard but is generally not available.

Other casing joining methods such as flush-threaded, threaded and coupled, splined, and cam-loc, are not known to be made which meet the standards, except that flush-threaded pipe is allowed for monitoring wells and environmental bore holes under limited conditions, see part 4725.6650.

## **REQUIRED MARKINGS ON PLASTIC WELL CASING**

### **American Society for Testing and Materials (ASTM) F480**

Plastic well casing pipe shall be marked at least every 1.5 m (5 feet), in letters not less than 5 mm (3/16 inch) high in a contrasting color with the following information:

1. Nominal well casing pipe size (for example, 5 inches);
2. Well casing pipe standard dimension ratio (for example, Standard Dimension Ratio 17);
3. Type of plastic casing pipe material (for example, ABS or PVC);
4. The wording “well casing” followed by the impact classification (for example, IC-3);
5. Designation “ASTM F480” including the year of issue of the standard with which the well casing pipe complies;
6. Manufacturer's name or trademark;
7. Manufacturer's code for resin manufacture, lot number, and date of manufacture;
8. The seal or mark of the laboratory making the evaluation of the plastic for potable water use spaced at intervals specified by the laboratory; and
9. Pressure rating (must be 200 psi or more).

**Subp. 2. Additional approved fittings and couplings.** In addition to the plastic couplings approved under subpart 1, the following fittings and couplings may be used to connect a steel pitless unit or screen to plastic casing:

A. fittings or couplings with socket dimensions meeting the requirements of ASTM Standard F480-02, Table 3 and having a water pressure rating of at least 200 psi;

B. Schedule 40, slip x internal thread fittings, four-inch and smaller meeting the requirements of ASTM D2466-02; or

C. Schedule 40, slip x internal thread fittings and slip x external thread fittings, five-inch diameter meeting the requirements of ASTM D2466-02.

Except for couplings to join plain-end pipe together by solvent welding, PVC manufacturers are not currently making fittings meeting the F480 standard because of the relatively small well market. Since some necessary fittings are not made, the rule has been amended to allow some equivalent fittings manufactured for potable water piping (plumbing).

In addition to **couplings** which meet all the requirements of ASTM F480, the rules allow couplings that are manufactured to meet the dimensions of ASTM F480 and have a 200 psi rating. In addition, a 4-inch, Schedule 40, PVC, “transition” fitting from solvent welded to internal threads is approved; and a 5-inch, Schedule 40, PVC transition fitting from solvent welded to either internal or external threads is approved.

“Deep socket” Schedule 40 (PVC1120, PVC1220, or PVC2120), NSF potable-water approved, 4-inch, and smaller slip X slip couplings are approved for solvent welding two pieces of plain end plastic casing together. The practice of using this coupling to connect steel casing to plastic casing is not approved. Standard “shallow” slip X slip couplings are not approved.

Nonthreaded PVC couplings greater than 4 inches in diameter must meet all of the ASTM F480 standards or the standards of ASTM F480 Table 3 and be:

- Schedule 80 up to 12 inches in diameter if made of PVC1120, PVC1220, or PVC2120;
- Schedule 80 up to 8 inches in diameter if made of PVC2116; or
- SDR 21 if made of PVC1120, PVC1220, or PVC2120.

**Subp. 3. Compliance with ANSI/NSF standard required.** All plastic casings, couplings, components, and related joining materials including solvents, cements, or primers used in the construction of a well or boring must conform with the requirements of ANSI/NSF Standard 61-2003e or the health effects portion of ANSI/NSF Standard 14-2003 and be tested as conforming by an agency certified by the ANSI. Conformance to the ANSI/NSF standard must be coded, stamped, or marked on the casings, couplings, components, and related joining materials including solvents, cements, or primers.

Products certified to conform to **ANSI/NSF** standards must bear the mark of the testing agency certified by the ANSI. Standards 61 and 14 were developed by NSF International (formerly the National Sanitation Foundation), and approved by ANSI/NSF International. NSF both develops standards and tests materials to determine if they meet the standard. While NSF International is currently the largest organization testing products for compliance with Standards 61 and 14, other organizations can be, and are, accredited to test products.

At the present time, NSF International, Underwriters Laboratory (UL), the Water Quality Association (WQA), the International Association of Plumbing Mechanical Officials (IAPMO), and CSA International also tests products for compliance. Materials that meet the ANSI/NSF standard must be marked with the insignia of the certified testing organization. For example, the NSF mark is a rectangular label or plate with “NSF” in a circle and the product trade designation number. For products where the label is not feasible or practicable, a block with the letters “ANSI/NSF” followed by the standard number is used. Materials meeting ANSI/NSF Standard 61 would be marked “ANSI/NSF-61.” Plastic piping components certified under Standard 14 are marked “pw” for potable water, or “wc” for well casing.

*STAT AUTH: MS s 103I.101; 103I.111; 103I.205; 103I.221; 103I.301; 103I.401; 103I.451; 103I.501; 103I.525; 103I.531; 103I.535; 103I.541; 103I.621; 144.05; 144.12; 144.383; 157.04; 157.08; 157.09; 157.13*

*HIST: 17 SR 2773; 33 SR 211*

**4725.2600** [Repealed, 17 SR 2773]

### **4725.2650 PLASTIC CASING INSTALLATION.**

- Subpart 1. General. When preparing to install plastic casing, a person must:*
- A. inspect casing and couplings carefully for cuts, gouges, deep scratches, damaged ends, and other major imperfections, and not use any plastic casing or coupling having such defects or imperfections;*
  - B. use solvent cement meeting the requirements of the specifications for the plastic that will be used;*

Solvent cement manufactured for use with ABS pipe must not be used for PVC pipe.

- C. use only casing and coupling combinations that give interference fits;*

“**Interference fit**” means that the pipe socket (bell end) is tapered. The pipe outside diameter is equal to the socket inside diameter at a point approximately one-third from the socket bottom. This results in a tight fit of pipe to socket.

- D use plastic couplings with molded or formed threads and thread lubricants suitable for the plastic material that will be used; and*

Threads must be molded or formed in the manufacturing process, cut threads are not approved. Threaded and coupled well casing meeting the ASTM F480 Standard is generally not manufactured.



*E. use a coupling appropriate for the specific transition intended when a nonplastic screen is attached to a plastic casing.*

Screens may be threaded or solvent welded to the casing or may be telescoped into the casing with a nontoxic packer.

*Subp. 2. **Cutting.** When cutting plastic casing, casing ends must be cut square using fine-tooth blades with little or no set or a plastic pipe cutter equipped with extra wide rollers and thin cutting wheels. Standard steel pipe or tubing cutters must not be used for cutting plastic casing.*

Plastic casing is extremely brittle when cold. Cutting plastic casing in winter must be done with caution.

*Subp. 3. **Cleaning.** All dirt, dust, moisture, and burrs must be cleaned from casing ends and couplings using chemical or mechanical cleaners suitable for the particular plastic material. All burrs must be removed.*

*Subp. 4. **Primer.** A primer must be used when the type of solvent cement used requires one.*

*Subp. 5. **Cementing.** An even coat of cement must be applied to the inside of the couplings to cover the distance of the joining surface only. An even coat of solvent cement must then be applied to the outside of the casing being joined to a distance equal to the depth of the casing coupling socket.*

Solvent cements contain Volatile Organic Chemicals (VOCs) such as acetone, tetrahydrofuran, methyl ethyl ketone, and others. Application of excessive cement does not improve joint strength and may lead to VOC contamination of the water. Over application may also create a ridge that will interfere with installation of a pump.

*Subp. 6. **Assembling.** When assembling plastic casing, a person must:*

- A. make the joint with solvent cement before the solvent cement dries;*
- B. reapply cement before assembling if the solvent cement dries partially;*
- C. turn the casing to evenly distribute the solvent cement while inserting the coupling into the coupling socket;*
- D. insert the casing to the full depth of the coupling socket and assemble casing;*
- E. remove excess solvent cement from the exterior of the joint with a clean, dry cloth;*
- F. tighten a threaded joint by no more than one full turn using a strap wrench;*

This means that after the joint is hand tight, a strap wrench (not a pipe wrench) is used to tighten the joint no more than one turn. Over tightening may crack the joint.

*G. not disturb the coupling joint until after the solvent cement has set; and  
H. allow sufficient time for the solvent cemented joint to set.*

The amount of time necessary for adequate joint set is dependent on pipe diameter, solvent type, temperature, and humidity. Large diameter pipe, low temperature, and high humidity slow set times. Recommended set times are found in the appendix of earlier versions of the ASTM F480 standard, and can be many hours.

*Subp. 7. Screws. Screws must not be used to join plastic casing.*

**Solvent welded bell and spigot, or threaded joints** are the only connections allowed between plastic casings. Rivets, bolts, screws or any other type of fasteners are not allowed for connecting plastic casing. These devices actually weaken the joint, and may allow leakage of contaminants into the well or boring.

**Screws** may not be used to join plastic casing, regardless of the type or length of the screws, or the depth of the hole drilled into the bell end.

*Subp. 8. Drilling inside permanent plastic casing prohibited. A person must not drill inside permanent plastic casing. Drilling tools such as drill bits must not be inserted in plastic casing. This prohibition does not include the installation or repair of screens or development of the well or boring.*

The reason for this requirement is to prevent damage to the plastic casing from drilling tools. All types of drilling tools are prohibited from insertion or use inside a permanent plastic casing. Permanent plastic casing may not be drilled through. Plastic casing may not be installed over drilling tools already in the hole. This does not prohibit the insertion of bailers, jetting tools, pumps, or other equipment to develop a well, nor does it prohibit the insertion of a tool such as a taper tap to remove a screen. This also does not prohibit drilling through a temporary plastic pit pipe or surface casing if the casing is removed. Tools used for development, screen placement, screen retrieval, or setting a pump may be inserted in plastic casing. Development of a well or boring with air through drill rods is allowed as long as a drill bit is not connected to the drill rod. These activities are permitted since there are no reasonable alternatives; however, they can damage the casing if not carefully done.

*Subp. 9. Limestone, dolomite restriction. Plastic casing must not be used as an outside casing in wells and borings cased more than five feet into limestone or dolomite bedrock. In limestone and dolomite bedrock, plastic casing may be used as an inner casing if surrounded for the entire length, by an outer steel casing.*

Limestone and dolomite are rocks comprised of calcium and magnesium carbonate. Further explanation is found in Minnesota Rules, part 4725.1851.

This rule was established to prevent casing deformation due to the heat of hydration from cement grout. Neat-cement or cement-sand grout is required in bedrock. Limestone or dolomite may have large fractures, solution cavities, and even caves. Cement grout in a large cavity may generate sufficient heat to deform or melt plastic casing. Bentonite grout is not an acceptable alternative since it will not support the casing and may wash away in karsted formations.

Diagrams of plastic casing construction are included in the grouting section, Minnesota Rules, part 4725.3050.

***Subp. 9a. Plastic cased wells or borings completed in bedrock. A plastic cased well or boring completed in bedrock, whether screened or open hole, must be cased into the bedrock a minimum of five feet and the annular space surrounding the casing in bedrock must be filled with neat-cement grout or cement-sand grout according to part 4725.3050, subpart 7.***

The rules do not allow the interconnection of an aquifer in unconsolidated sediments with an aquifer in bedrock. When a well or boring is completed in bedrock below unconsolidated sediments it is necessary to cement the annular space since the plastic cannot be driven, and a hole larger than the casing must be drilled in order to install the casing. Bedrock must be grouted with neat-cement or cement-sand grout.

***Subp. 10. Driving prohibition. Plastic casing must not be driven. Use of a drive shoe with plastic casing is prohibited.***

Forcing plastic casing in the ground may deform the casing.

***Subp. 11. Sealing, removal, or replacement. A person installing plastic casing must either seal a well or boring or remove and replace all casing when:***

- A. the plastic casing cannot be installed without driving the casing;***
- B. a screen or pump cannot be installed without force; or***
- C. the casing fails during construction or pumping of the well or boring.***

Plastic casing does not have the strength or collapse resistance of steel casing. Boulders, improper grouting, crooked holes, or excessive depth and low water levels may cause damage to the casing. This rule subpart establishes that the contractor is responsible for damage or errors of installation.

***STAT AUTH: MS s 103I.101; 103I.111; 103I.205; 103I.221; 103I.301; 103I.401; 103I.451; 103I.501; 103I.525; 103I.531; 103I.535; 103I.541; 103I.621; 144.05; 144.12; 144.383; 157.04; 157.08; 157.09; 157.13***

***HIST: 17 SR 2773; 33 SR 211***

***4725.2700 [Repealed, 17 SR 2773]***

## **4725.2750 SCREENS; SCREEN LEADERS, RISERS, AND SUMPS.**

*If a screen is attached or connected to the casing, the connection must be made by a threaded, solvent-welded, or welded joint, or by a nontoxic packer. Lead packers must not be used. A screen riser or leader must not extend more than 21 feet above the screen. A screen sump must not extend more than ten feet below the screen. The total combined-length of screen riser or leader, and screen sump must not exceed 21 feet. A screen riser or leader, or screen sump must comply with the confining layer requirements of part 4725.2020, subpart 1a. Multiple screens separated by a screen riser, leader, or sump are not permitted.*

“Screen” means a sieve or strainer-like device that serves as the intake portion of the well or boring.

“Screen risers/leaders or blank screens and screen sump” may also be referred to as blanks, risers, zero-slot screens, screen extensions, or leader pipes, and are pieces of pipe attached to the top or bottom of a screen.

A screen is not required by rule. A well or boring may have an open hole or an “open bottom” in an unconsolidated formation. However, not installing a screen in an unconsolidated formation may lead to the well producing excessive amounts of sand, or sand heaving into the casing.

The rules do not contain standards for screen, screen riser/leader, or sump material, slot size, or screen design. However, Minnesota Rules, part 4725.4650 requires a potable water-supply well to provide water with less than 5 milligrams per liter (mg/L) sand and no more than 200 mg/L of silt and clay.

The installation of a screen and/or screen leader/riser inside an existing screen, screen leader/riser or open bore hole (sometimes referred to as a channel pack screen) is not prohibited by rule. If alterations are made to a well or boring that do not require a permit or notification, the contractor is urged to send in an amended record; however it is not required.

The rules contain requirements for screen location.

Minnesota Rules, part 4725.2020, requires that a well or boring must not have open bore hole, gravel pack, or screen extending through more than:

- A. 10 feet of a confining layer, except for the Decorah or Glenwood formations;
- B. 2 feet of the Decorah or Glenwood formations; and
- C. 50 percent of the confining layer.

Minnesota Rules, part 4725.2850 prohibits gravel pack from extending: more than 10 feet above or below a screen when a screen riser/leader or sump is not used; above the top of a screen riser or leader or below the screen sump; or through more than 10 feet of an open hole.

Minnesota Rules, part 4725.3050 requires that if a bore hole extends more than 10 feet below the bottom of a screen, the bore hole must be filled with grout from the bottom of the bore hole to within 10 feet or less of the screen.

One purpose of this rule is to prevent permeable materials (sand, gravel pack) from filling a bore hole below the bottom of the screen. If a hole is drilled deeper than the interval in which the screen will be set, the bore hole below the screen must be grouted. It is not permissible to allow the hole to collapse or fill the hole with gravel pack.

“Filling” of the bore hole must be done in accordance with Minnesota Rules, part 4725.3850 which requires grout to be pumped through a tremie pipe from the bottom of the hole upward.

Minnesota Rules, part 4725.3750 requires a property owner to have a defective part of a well or boring repaired, including a screen.

A permit or notification is not required for installation or repair of a screen, or screen riser/leader and sump in an existing well or boring (Minnesota Rules, part 4725.1837).

Lead packers or other lead components such as lead wool must **not** be used.

It is no longer required to attach a screen to a casing. If a connection is made, it must be with a threaded, welded, or solvent-welded connection or a nontoxic packer. Rivets, screws, pins, splines, or other mechanical fastening devices may not be used.

In some contamination cases, it may be necessary to monitor or remediate across the contact between an unconsolidated formation and rock. This typically involves gasoline or other hydrocarbons floating on the water surface which is near the drift/rock contact. Rules have been developed to allow a screen or open hole in a monitoring well, remedial well or environmental bore hole to breach the contact in some cases. For further information see Minnesota Rules, parts 4725.6050, 4725.6650, and 4725.7450.

*STAT AUTH: MS s 103I.101; 103I.111; 103I.205; 103I.221; 103I.301; 103I.401; 103I.451; 103I.501; 103I.525; 103I.531; 103I.535; 103I.541; 103I.621; 144.05; 144.12; 144.383; 157.04; 157.08; 157.09; 157.13  
HIST: 17 SR 2773; 33 SR 211*

**4725.2800** [Repealed, 17 SR 2773]

**4725.2850 GRAVEL PACKS.**

*Gravel packs, filter sand, or stabilizer materials must be comprised of mineral material or inert, non-toxic artificial materials, contain less than five percent calcareous material, and must be graded, cleaned, and washed.*

*Gravel packs, filter sand, or stabilizer materials must not extend:*

- A. more than ten feet above the static water level;*
- B. more than ten feet above the top or below the bottom of the screen when a screen riser or leader, or screen sump is not installed;*

- C. above a screen riser or leader, or below a screen sump;*
- D. through a confining layer in violation of part 4725.2020, subpart 1a; or*
- E. through more than ten feet of open hole.*

“Calcareous material” means soil or rock that contains lime, such as crushed limestone.

Gravel packs must be placed by methods that prevent bridging of the material, and allow verification of placement.

Installation of temporary gravel packs must meet rule.

Minnesota Rules, part 4725.2020, requires that a well or boring must not have open bore hole, gravel pack, or screen extending through more than:

- A. 10 feet of a confining layer, except for the Decorah or Glenwood formations;
- B. 2 feet of the Decorah or Glenwood formations; and
- C. 50 percent of the confining layer.

Minnesota Rules, part 4725.4550, requires that a potable water-supply well must be cased to a depth of at least 15 feet from the established ground surface. The top of a gravel pack must terminate at least 15 feet below the established ground surface. Exempt are nonpotable water-supply wells, remedial wells, monitoring wells and environmental bore holes.

In the case where no confining layer exists in the area of the sump, screen and riser or leader, and the static water level of the formation being screened is above the top of the riser or leader pipe:

- If no sump is used below the screen, up to 21 feet of riser or leader pipe may be used above the screen, and the screen and the entire length of the riser or leader pipe may be gravel packed.
- If 10 feet of sump is used below the screen, up to 11 feet of riser or leader pipe may be used above the screen, and the screen, sump, and entire length of the riser or leader pipe may be gravel packed.
- If 5 feet of sump is used below the screen, up to 16 feet of riser or leader pipe may be used above the screen, and the sump, screen and entire length of the riser or leader pipe may be gravel packed.

See Minnesota Rules, part 4725.2750 for sump, screen and riser or leader pipe allowable combinations.

A well or boring without a screen (open hole or open bottom), may only have gravel pack for a maximum of 10 feet.

A gravel pack must not extend more than 10 feet inside a casing.

*STAT AUTH: MS s 103I.101; 103I.111; 103I.205; 103I.221; 103I.301; 103I.401; 103I.451; 103I.501; 103I.525; 103I.531; 103I.535; 103I.541; 103I.621; 144.05; 144.12; 144.383; 157.04; 157.08; 157.09; 157.13*  
*HIST: 17 SR 2773; 33 SR 211*

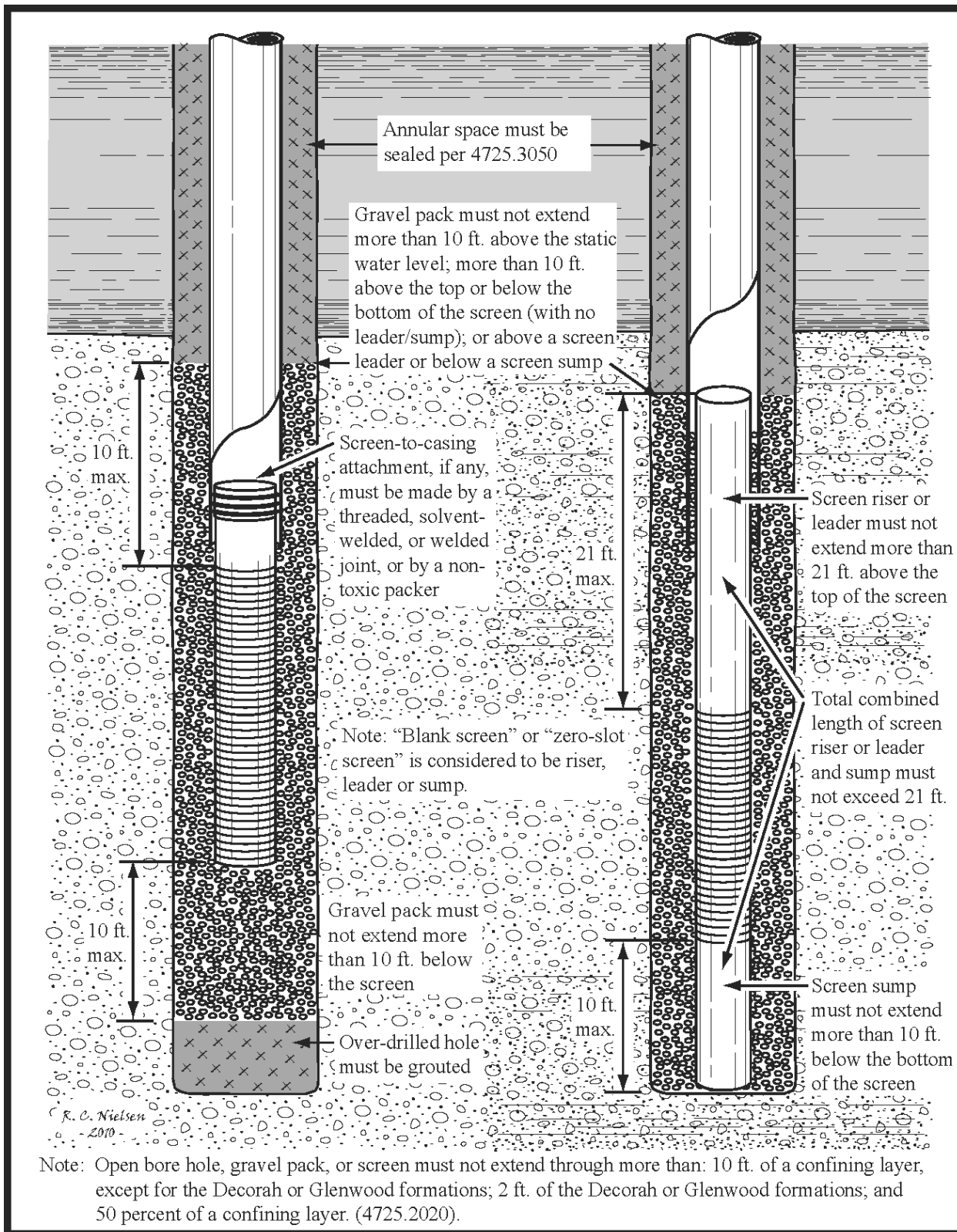

Figure 12. Screen, Leader, Sump and Gravel Pack Installation

**4725.2900 [Repealed, 17 SR 2773]**

**4725.2950 DRILLING FLUIDS.**

*Subpart 1. Water. Water used for drilling, development, hydrofracturing, sealing, repair, or rehabilitation, other than water from the well or boring itself, must:*

*A. come from a potable water system or from a well or boring of similar use and construction;*

“Potable water” means water which is safe for human consumption in that it is free from impurities in amounts sufficient to cause disease or harmful physiological effects.

Water may be taken from a potable water system for use in drilling, development, hydrofracturing, sealing, repair or rehabilitation any type of well or boring. Water may be taken from one type of well or boring to drill another well or boring of the same type. For example, water may be taken from a domestic water-supply well to drill another water-supply well, but water may not be taken from a monitoring well to drill a water-supply well or remedial well.

Water may **not** be taken from a **pond, lake, ditch**, excavation, or other unsafe surface source. Besides containing potentially harmful bacteria or viruses, surface water may contain nuisance organisms such as iron bacteria.

*B. contain a free chlorine residual at all times, except for monitoring wells and remedial wells where chlorine will interfere with water quality analysis or remediation; and*

A **free chlorine residual** means that enough chlorine has been added to leave a measurable quantity of chlorine in the water. Sufficient chlorine must be added to overcome the chlorine demand of the water. Organics, iron, bacteria, scale, or other materials in the water, casing, or water system will “use up” the chlorine (create a chlorine demand). Additional chlorine may be needed during the drilling process to make up for the chlorine demand.

A **monitoring well** is exempt from the chlorine residual requirement by Minnesota Rules, part 4725.6650. However, it is recommended that, where feasible, monitoring wells be disinfected to prevent bacterial contamination, bacterial alteration of water chemistry, and bio-fouling.

**Remedial wells** may be constructed without chlorinated drilling water if the chlorine will interfere with water quality analysis or if addition of the chlorine will adversely react with solvents or other chemicals in the well. However, chlorine is recommended for the reasons noted above.

*C. be conveyed and stored in clean, sanitary tanks and water lines.*

It is required to use chlorinated water for drilling, development, and the other activities identified in subpart 1.

It is not required to add chlorine to a mobile tank prior to transport. The chlorine may be added at the jobsite just prior to use. However, addition of chlorine prior to transport will usually result in thorough mixing and elimination of nuisance bacteria. If a granular chlorine product is placed into a steel tank



without premixing, it may settle and result in corrosion of the tank. It is a good idea to pre-dissolve granular chlorine in a bucket of potable water prior to addition to a steel tank.

***Subp. 2. Drilling additives. Drilling additives, including bentonite, must meet the requirements of ANSI/NSF Standard 60-2003e as determined by a person accredited by the ANSI under ANSI Standard Z34.1-1993. A drilling additive is a substance added to the air or water used in the fluid system of drilling a well or boring.***

Drilling additives include bentonite drilling muds, drilling mud conditioners, water conditioning chemicals for drilling fluids and grouts such as soda ash, air-rotary foams, and lost circulation materials.

Drilling additives must meet the requirements of ANSI/NSF Standard 60. “NSF,” formerly known as the National Sanitation Foundation, is an organization which both establishes standards, and tests and certifies numerous products. “ANSI” refers to the American National Standards Institute. The ANSI standard refers to accreditation of the testing laboratory. Any laboratory which is accredited by ANSI may test products against the standard. At the present time, only NSF is actively testing drilling additives.

Two lists of currently approved drilling additives are included in the appendix. The first is a list of ANSI/NSF Standard 60 certified drilling aids and sealants, and consists primarily of bentonite-based products, but also includes NSF certified organic polymers, foaming agents, and cellulose-based products. The second is a list of other products approved by the MDH for use as foaming agents, weighting materials and lost circulation materials.

***STAT AUTH: MS s 103I.101; 103I.111; 103I.205; 103I.221; 103I.301; 103I.401; 103I.451; 103I.501; 103I.525; 103I.531; 103I.535; 103I.541; 103I.621; 144.05; 144.12; 144.383; 157.04; 157.08; 157.09; 157.13  
HIST: 17 SR 2773; 33 SR 211***

#### ***4725.2975 DISPOSAL OF MATERIALS.***

***The disposal of drilling mud, cuttings, treatment chemicals, and discharged water must be according to applicable state and local regulations. Drilling mud, cuttings, and discharged water must not be disposed in a manner that creates a health hazard. During test pumping, discharged water must be piped to a point of overland drainage.***

Municipalities have expressed concern about disposal of debris, cuttings, and grout in sanitary or storm sewers. They have reported instances of sewer plugging and have indicated that contractors may be fined and charged removal costs.

Drilling mud, cuttings, grouts, treatment chemicals, and discharge water should not be allowed to enter surface water streams, rivers, ponds, lakes, or wetlands. Persons responsible for such discharges may be subject to federal, state (i.e., MPCA, DNR) or local enforcement actions.

Drilling mud, cuttings, treatment chemicals, or discharged water may contain contaminants such as PCBs from older submersible pumps. Information concerning proper disposal of contaminated materials may be obtained from the MPCA, Telephone Number – metro 651-296-6300 and outstate 800-657-3864 or their Web site at [www.pca.state.mn.us](http://www.pca.state.mn.us). Environmental releases must be reported to the Minnesota Duty Officer at 651-649-5451 or 800-422-0798.

*STAT AUTH: MS s 103I.101; 103I.221; 103I.301; 103I.621; 144.05; 144.12; 144.383; 157.04; 157.08; 157.09; 157.13*

*HIST: 17 SR 2773*

**4725.3000** [*Repealed, 8 SR 1625*]

**End  
of  
Screens, Drilling Fluids Section**

## **4725.3050 GROUTING.**

*Subpart 1. Grouting materials. The following grout materials as listed in part 4725.0100 are approved for filling an annular space between unconsolidated material or bedrock and a casing:*

“**Grout**” means a material used to fill the annular space around a casing, or to seal a well or boring. The purposes of grout are to: protect a well, boring, and aquifer from contamination; prevent interaquifer flow; prevent uncontrolled flowing wells or borings; preserve different aquifer chemistries; protect casing from corrosion; and prevent casing failure from deformation.

Approved grouts are neat-cement grout, cement-sand grout, and bentonite grout.

Treatment chemicals used to condition water for mixing grouts must meet the standards for drilling additives, ANSI/NSF Standard 60-2003e.

*A. neat-cement grout, except that rapid setting cement must not be used with plastic casing;*

“**Neat-cement grout**” means a mixture in the proportion of 94 pounds of Portland cement and not more than 6 gallons of water. Bentonite up to 5 percent by weight of cement (4.7 pounds of bentonite per 94 pounds of Portland cement) may be used to reduce shrinkage. Additives to reduce permeability or control setting time must meet ASTM Standard C494/C494M-04. Additional information is found under the definition of “neat cement” in Minnesota Rules, part 4725.0100.

### **NEAT-CEMENT GROUT FORMULA**

- 94 pounds of Portland cement; and
- Not more than 6 gallons of water.
- Up to 5 percent of bentonite (4.7 pounds per 94 pounds of Portland cement) may be added.

Some manufacturers are supplying Portland cement in 42 kilogram (92.6 pound bags). The formula for neat-cement grout remains: not more than 6 gallons of water to 94 pounds of Portland cement. The formula for the 42 kilogram bags is:

- Not more than 5 gallons and 117 fluid ounces of water (11 ounces less than a gallon), and
- 42 kilograms (92.6 pounds) of Portland cement.
- Not more than 5 percent cement bentonite (4.6 pounds) may be added.

Neat-cement grout made with 5.4 gallons of water instead of 6 gallons will result in a grout that has less shrinkage and is less permeable.

“**Rapid setting cement**” means a Type III Portland cement as designated in ASTM Standard C150-04a, or any Portland cement containing an accelerated admixture. “Rapid-setting cement” must be mixed in the proportion of 94 pounds of Portland cement and not more than 6 gallons of water. Additional information is found under the definition of “rapid-setting cement” in Minnesota Rules, part 4725.0100

One cubic yard of neat-cement grout contains 1993 pounds of Portland cement and not more than 127 gallons of water.

The following is a table of cement/water ratios and the resultant minimum density of the mixture when weighed with a mud scale:

If bentonite is added to neat cement, additional water may be added according to the following table:

**NEAT-CEMENT AND BENTONITE GROUT WATER RATIOS AND DENSITIES**

<u>MIXTURE</u>	<u>WATER RATIO (gal./bag of cement)</u>	<u>MINIMUM DENSITY (lbs./gal.)</u>
Neat cement	6.0	15.0
Neat cement & 1% Bentonite	6.0	15.0
Neat cement & 2% Bentonite	6.5	14.7
Neat cement & 3% Bentonite	7.2	14.4
Neat cement & 4% Bentonite	7.8	14.1
Neat cement & 5% Bentonite	8.5	13.8

***B. cement-sand grout; and***

“**Cement-sand grout**” means a mixture of Portland cement, sand, and water in the proportion of 94 pounds of Portland cement, not more than 1.0 cubic foot of dry sand, and not more than 6 gallons of water. Admixtures to reduce permeability or control setting time must meet ASTM Standard C494/494M-04.

**CEMENT-SAND GROUT FORMULA**

- 94 pounds of Portland cement;
- Not more than 6 gallons of water.
- 1.0 cubic feet of sand (approximately 105 pounds)

**ONE CUBIC YARD OF CEMENT-SAND GROUT**

	<u>BY VOLUME</u>	<u>BY WEIGHT (lbs.)</u>
Portland Cement	13.5 (94 lbs.) bags	1269
Washed Sand	13.5 cubic feet	1418
Water	81 gallons	676
Yield	1 cubic yard	3363 lbs.

### *C. bentonite grout when used in unconsolidated materials.*

Bentonite grout may only be used in unconsolidated formations, not in rock. Unconsolidated materials includes glacial drift (glacial till and glacial outwash), clay, silt, sand, gravel, and cobbles. Cretaceous age formations, found mainly in southwestern Minnesota, are also considered as unconsolidated materials for the purposes of these rules.

“**Bentonite grout**” means:

- Water and a minimum of 15 percent by weight of bentonite, with no additives to promote temporary viscosity.
- An additional 15 percent by weight of either washed sand, cuttings taken from the bore hole, or granular bentonite may be added.

Bentonite used for grout must either be natural-mined montmorillonite clay without additives or be a bentonite meeting ANSI/NSF Standard 60. The bentonite must be designed by the manufacturer as a grout and must be mixed to manufacturer’s specifications and the minimum standards of these rules. A grout designed by the manufacturer to be 10 percent bentonite solids may not be used since it does not meet the 15 percent minimum. A 30 percent solids bentonite grout may not be diluted to a 15 percent solids mixture.

### **BENTONITE GROUT FORMULA**

- 50 pounds of bentonite; and
- 34 gallons of water.
- An additional 50 pounds of washed sand, cuttings, or granular bentonite may be added.

Bentonite is commonly sold in 50 pound sacks.

Thirty-four gallons of water weighs approximately 283 pounds.

Fifty pounds of washed sand or cuttings are approximately equal to 1/2 cubic foot, 3.2 gallons, or 2/3 of a 5 gallon pail.

Higher percentages of bentonite may be used and are encouraged.

High-yield drilling fluid bentonites that are not designed by the manufacturer for use as grout are not allowed for use as grout. High yield drilling fluid bentonites, particularly when they are mixed using with a high shear pump or mixing system, may be difficult or impossible to mix to the required bentonite content. Bentonite grouts tend to be either coarser-grind bentonites, lower-yielding bentonites, or bentonites containing additives to slow wetting and expansion.

Contractors have reported success mixing up a slurry of 10 percent bentonite and water, and then paddle mixing in 5 or more percent of granular bentonite to the point that the granular bentonite is dispersed but not completely mixed. This “Ohio” mixture has the consistency of cottage cheese. Since the bentonite has not fully hydrated, working times are typically less than 30 minutes until the mixture becomes too thick to pump.

Contractors have also reported success by adding granular bentonite into the mud box near the mud pump suction intake and drawing into the suction hose a mixture of bentonite grout and granular bentonite. This mixture is then immediately pumped into the well or boring through the drill rods. Tests on the resultant grout have indicated that this practice can result in a legal grout. However, this method has potential problems including plugging of the suction hose, inconsistent mixtures, and dilution. If this method is used, caution must be taken to assure that the resultant grout meets the minimum specification, is verifiable, and is not diluted.

The approximate density (weight) of 15 percent solids bentonite grout without the addition of sand or cuttings is 9.1 lbs./gallon.

Bentonite grout (or other grout) mixtures can be verified to meet the rules by the use of a mud balance. A specified quantity of the grout is weighed, which results in a bulk density. Approximate densities are as follows:

Fluid	Density
Water	- 8.3 lbs./gal.
Drilling mud (6 percent bentonite and water)	- 8.6 lbs./gal.
15 percent bentonite and water	- 9.1 lbs./gal.
30 percent bentonite and water	- 9.9 lbs./gal.

***Subp. 2. Grouting requirements and methods. The following general requirements apply to the grouting of wells and borings.***

***A. Grouting must start immediately on completion of drilling and be completed before placing a well or boring in service.***

If the drilling machine is removed from the well or boring and no more hole will be advanced, drilling is completed and grouting must begin immediately.

***B. The annular space to be grouted must be protected from collapse and the introduction of materials other than grout.***

**Collapse** must be prevented, and also the introduction of materials, including cuttings, into any annular space that is required to be grouted.

***C. A steel plate, or a nontoxic metal, rubber, or plastic grout basket may be attached to the casing within ten feet of the bottom. Wood, burlap, or other organic material must not be used.***

These are sometimes referred to as “formation packers” or “shale traps.”

The grout basket must be within the aquifer and must not be within an overlying aquifer or confining layer. If a well is cased with plastic casing only 5 feet into bedrock, a grout basket may not be used.

*D. Grout must be pumped under pressure into the annular space from the bottom up to the established ground surface or base of the pitless adapter or unit. Grout must be pumped through the casing or through a tremie pipe placed within ten feet of the bottom of the space to be grouted. The tremie pipe may be retracted as grouting proceeds; however, the bottom of the tremie pipe must remain submerged in grout while grouting.*

Pumping of grout in the annular space may be accomplished by using any type of pumping pressure including mechanical, air, or human powered pumps. Typical pumps used include mechanical pumps such as piston pumps, drill rig mud pumps, Moyno-type rotor pumps, air pressure pumps such as a Wilden pump, or various hand pumps.

A tremie pipe, also referred to as a grout pipe, is a small diameter pipe, hose or tube used to convey grout. The pipe is commonly steel or plastic, but may be a flexible hose, and even copper has been used. Flexible pipe, and at times rigid pipe, can be loosely fastened to, or installed with the casing. The tremie pipe is usually installed between the casing and hole, but in some methods it is installed inside the casing, and may be connected to (as a “stinger”) a float or grout shoe attached to the bottom of the casing.

The **tremie pipe must be set to within 10 feet** of the bottom of the annular space to be grouted.

The casing may also be used to install the grout, through use of one or more plugs (Halliburton method), Bradenhead, or casing fitting method.

In addition to grouting through a tremie pipe, grouting may also be completed by use of the displacement method. The displacement method allows placement of grout in the bore hole and then setting the casing with a bottom plug into the grout-filled bore hole.

The appendix contains tables of bore hole and annular volumes.

*E. Grout flowing out of the annular space at the surface must meet the minimum specifications and densities in this chapter before grouting may stop.*

The grout must be pumped until the **entire annular space** to be grouted is filled with grout material meeting the minimum specifications. The first grout which appears at the surface is often thinned by formation water. The density of the grout should be measured before it is pumped and then pumped until the same density appears at the surface.

*F. Dumping of grout is not allowed except when the depth of the space to be grouted is less than ten feet.*



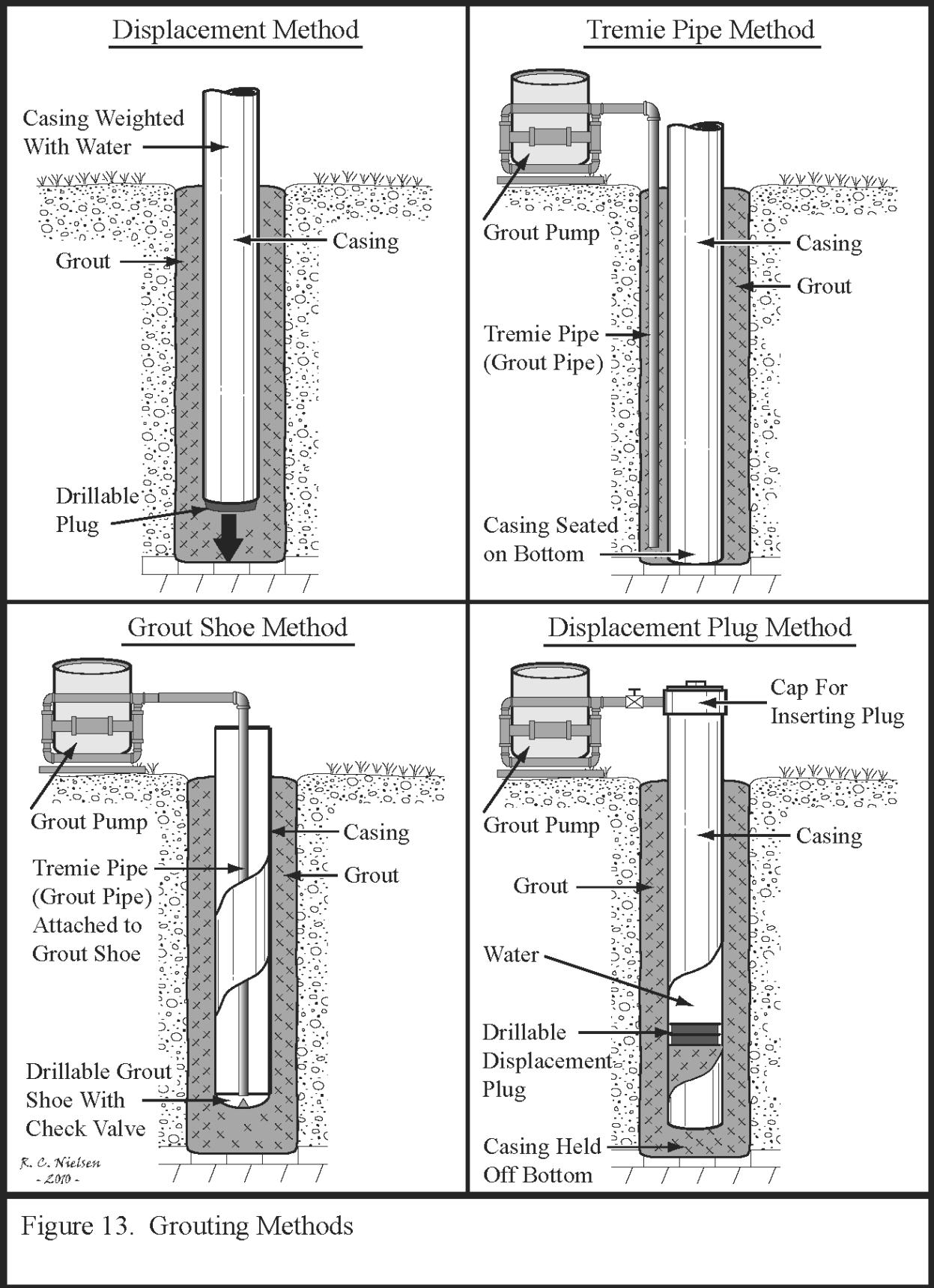

Figure 13. Grouting Methods

**Subp. 2a. Wait on cement.** Neat-cement grout or cement-sand grout must be allowed to set a minimum of 24 hours. Rapid setting cement must be allowed to set a minimum of 12 hours. Drilling, development, or pump operation is prohibited during the time the cement is setting.

The prohibition of pump operation during the time the cement is setting does not prohibit the pumping of a flowing well during the grouting process in order to grout.

**Subp. 3. Grouting depth requirement.** When constructing a well or boring with a method such as mud or air rotary, auger, or jetting that creates an open annular space or drills a bore hole larger than the casing or casing couplings outside diameter, a grouting material specified in subpart 1 and the grouting methods specified in subpart 2 must be used to fill the annular space between the casing and the bore hole.

The rules require the **top 50 feet** to be grouted in a well or boring that is constructed with a method which creates an annular space. An annular space is created when (1) a well or boring is drilled with an auger, bucket auger, rotary, jetting, hollow rod, or similar method and the casing is installed after the hole is drilled; or (2) a method is used that has cuttings return up the annular space between a casing or drill stem and the bore hole; or (3) a temporary outer casing is installed around a permanent inner casing and the other casing is removed. The annular space must be grouted through the casing or a tremie pipe. Bentonite grout may be used in unconsolidated formations. Neat-cement or cement-sand grout may be used in any formation. If the hole collapses, it will be necessary to clean the annulus by driving an outer casing, overdrilling, or removing the casing and enlarging the hole. The practice of jetting in a single tremie pipe and grouting the jetted hole is not allowed.

**A.** If the depth of the casing is 50 feet or less, the grout must extend from the bottom of the casing, top of the bentonite seal as specified in subpart 8, or top of the gravel pack, to the established ground surface, or the base of the pitless adapter or unit.

The 50-foot distance is measured from the land surface.

**B.** If the depth of the casing is more than 50 feet, the annular space below 50 feet must be filled with grout, except that the portion of the well or boring in an unconsolidated formation below 50 feet in depth may be filled with cuttings. The cuttings must be placed without bridging, and must be the unconsolidated materials taken from the bore hole. The annular space above 50 feet must be filled from:

(1) a depth of at least 50 feet to the established ground surface or the base of a pitless adapter or unit; or

(2) the top of the bentonite seal as specified in subpart 8 or the top of the gravel pack to the established ground surface or the base of a pitless adapter or unit.

This allows the use of **cuttings** taken from the bore hole to fill the annular space in unconsolidated materials below 50 feet. This does not allow the use of any other fill material such as sand, bentonite chips, or soil. If cuttings are not used to fill the annular space below 50 feet, or if the cuttings do not entirely fill the annular space from the top of the gravel pack to a depth of 50 feet, the annular space from the top of the gravel pack or above the cuttings must be grouted through a tremie pipe to the established ground surface or the base of a pitless adapter or unit. Cuttings must be emplaced so that bridging and bore hole collapse do not occur.

The MDH recommends that grout be used instead of cuttings. Settling of improperly placed cuttings can cause excessive settling of the grout placed above the cuttings and compromise the seal in the annular space of the well, the water quality in the aquifer, and the quality of a well owner's drinking water.

The **tremie pipe** must be installed to within 10 feet of the top of the cuttings or gravel pack.

This applies to any well or boring where an annular space is created between the casing and bore hole, which includes outer casings (or surface casings) on multiple-cased wells or borings and surface casing in unconsolidated materials if the casing is, intentionally or unintentionally, left in place.

It is recommended that wells or borings in which "**temporary**" **outer casing** is installed in unconsolidated materials be grouted around the outer casing in accordance with subpart 3 of this part with bentonite prior to drilling the bore hole below the surface casing. This will allow the contractor to retrieve the casing and will not result in a violation if the outer casing cannot be removed. If the outer casing is not grouted in place, at a minimum, the contractor should not allow cuttings to wash down the annular space between the outside of the surface casing and bore hole because the cuttings may inhibit the removal of the surface casing.

The rules require a casing to be surrounded with grout, or cuttings in unconsolidated formations below 50 feet, or undisturbed formation in the case of driven casings. The practice of installing **multiple casings in a single bore hole** with gravel pack surrounding screened intervals set at different depths does not meet the standards of the rules. Each casing must be in a separate bore hole.

Additional grouting requirements exist for confining layers, rock, flowing wells or borings, dewatering wells, monitoring wells, vertical heat exchangers, and elevator borings.

Driven  
Steel Casing

Rotary Drilled, Jetted,  
or Augered  
Steel or Plastic Casing

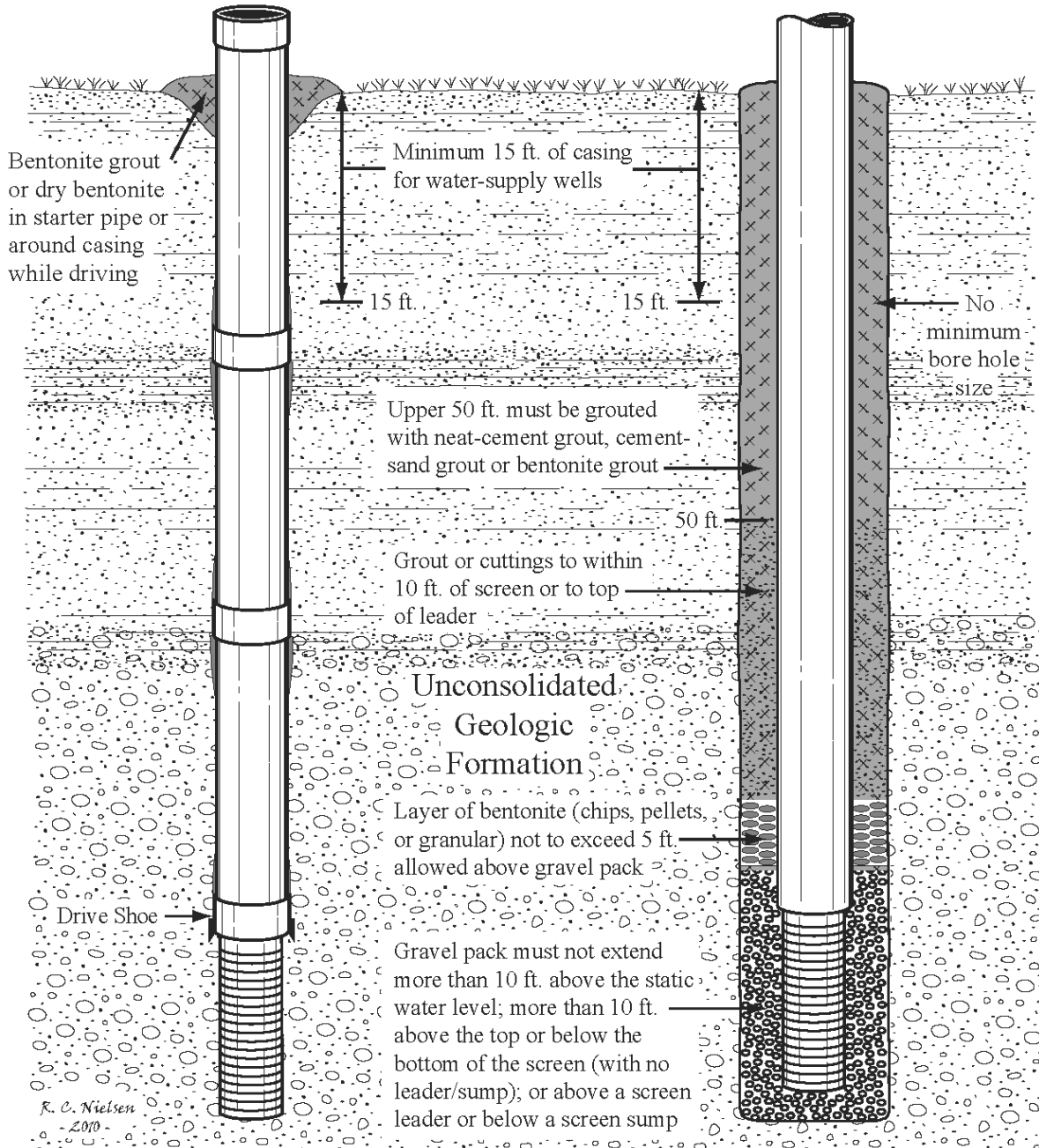

\* Note: See additional requirements or exemptions for confining layers, rock, limestone or dolomite, flowing wells and borings, dewatering wells, monitoring wells, vertical heat exchangers, and elevator borings.

Figure 14. Wells and Borings in Unconsolidated Formations\*

***Subp. 4. Grouting between casings. The annular space between an inner and outer casing, must be filled with neat-cement grout or cement-sand grout according to subpart 2.***

Minnesota Rules, part 4725.2250, subpart 8 requires that the inside diameter of an outer casing must be at least **3.0 inches larger** than the outside diameter of the inner casing, couplings or bell end, whichever is larger, for inner casings with 12 inches inside diameter and smaller. The inside diameter of an outer casing must be at least **3.5 inches larger** than the outside diameter of the inner casing, couplings or bell end, whichever is larger, for inner casings larger than 12 inches inside diameter and greater than 100 feet deep. The annular space between an inner casing and an outer casing must be grouted for its entire length by pumping neat-cement or cement-sand grout through a tremie pipe or through the casing as specified in Minnesota Rules, part 4725.3050. The inner casing must extend above the established ground surface at least 12 inches.

**Neat-cement grout or cement-sand grout** are the only types of grouts allowed between two casings.

A table of annular space volumes is included in the appendix.

***Subp. 5. Driving casing. When driving casing in an unconsolidated formation, a cone-shaped depression or temporary outer casing filled with bentonite grout, bentonite powder, or granular bentonite, must be maintained around the outside of the casing. The bottom of driven casing, except for a drive point, temporary casing, or outer casing that has a neat-cement or cement-sand grouted inner casing must be equipped with a drive shoe in accordance with part 4725.2250, subpart 15. Casing may only be driven through;***

- A. an unconsolidated formation;***
- B. sandstone bedrock including the St. Peter, Jordan, Franconia, Iron-ton-Galesville, Mt. Simon, Hinckley, or Fond du Lac formations;***
- C. ten feet or less of limestone or dolomite bedrock including the Cedar Valley through Galena groups, the Platteville formation, or the Prairie du Chien group;***
- D. ten feet or less of the St. Lawrence or Eau Claire confining layers; and***
- E. two feet or less of the Decorah or Glenwood confining layers.***

The cone-shaped depression or annular space between the temporary outer casing and the casing being driven must be kept filled with bentonite grout, bentonite powder, or granular bentonite, at all times during the advancement of the casing. Typically, 1 pound of dry granular bentonite is needed per foot of casing if driving 2-inch casing, and 2-1/2 pounds of dry granular bentonite is needed per foot of casing if driving 4-inch casing (one sack of bentonite for each 20-foot-casing section).

When using dry powdered or granular bentonite, care must be taken to keep the bentonite dry in order to facilitate the movement of the bentonite down around the casing as the casing is driven. The use of a temporary outer casing appears to be a more effective method than a cone-shaped depression at delivering the bentonite around the driven casing.

A cone-shaped depression or temporary outer casing is not required if the only time the casing is driven is to seat the casing into a rock unit (driven 10 feet or less). For information on driving casing more than 10 feet into a sandstone formation see subpart 7, item B, of this part.

A **drive shoe** is not required on a temporary casing, or on a lighter-weight outer casing in unconsolidated formations which is cement grouted with an inner casing. However, contractors are cautioned that they are responsible for deformation of the casing, failure of the well or boring, or collapse due to light-weight casing or the lack of a drive shoe. A well or boring which is not properly grouted or completed must be corrected or properly sealed by the contractor. Correction may include perforation, removal of casing, or overdrilling.

***Subp. 6. Sealing bore hole below screen. If a bore hole extends more than ten feet below the bottom of a screen, the bore hole must be filled with grout from the bottom of the bore hole to within ten feet or less of the screen.***

The purpose of this rule is to prevent permeable materials (sand, gravel pack) from filling a bore hole below the bottom of the screen. This is of particular importance in situations where collapsing sand, gravel, or gravel pack may penetrate a confining layer. If a hole is drilled deeper than the interval in which the screen will be set, the bore hole below the screen must be grouted. It is not permissible to allow the hole to collapse or fill the hole with gravel pack.

“Filling” (partial sealing) of the bore hole must be done in accordance with Minnesota Rules, part 4725.3850 which requires grout to be pumped through a tremie pipe from the bottom of the hole upward. Neat-cement or cement-sand grout must be used in rock, and neat-cement, cement-sand, or bentonite grout may be used in unconsolidated materials. Sealing the lower portion of a bore hole without sealing the target formation, and doing so with grout that is capable of supporting further well construction (i.e., neat-cement grout or cement-sand grout) presents several potential problems. Considering these problems, it may be advisable to seal the entire bore hole and start a new well or boring.

***Subp. 7. Grouting in bedrock. The additional requirements in items A to C apply to grouting a well or boring in bedrock.***

“**Bedrock**” includes shale, sandstone, limestone, dolomite, granite, basalt, quartzite, taconite, slate and other sedimentary, igneous, and metamorphic rocks. “Bedrock” also includes materials sometimes referred to as “slaterock,” “ledgerock,” or “traprock.”

For the purpose of these rules, “bedrock” does not include sediment of recent or glacial origin, regolith where the original cementaceous material has been weathered to the point that it no longer binds the matrix, or deposits of Cretaceous age.

***A. When bedrock is encountered in the construction of a well or boring, the casing must be equipped with a drive shoe driven firmly into stable bedrock or the casing must be grouted with neat-cement grout, or cement-sand grout from the bottom of the casing to the top of the bedrock.***

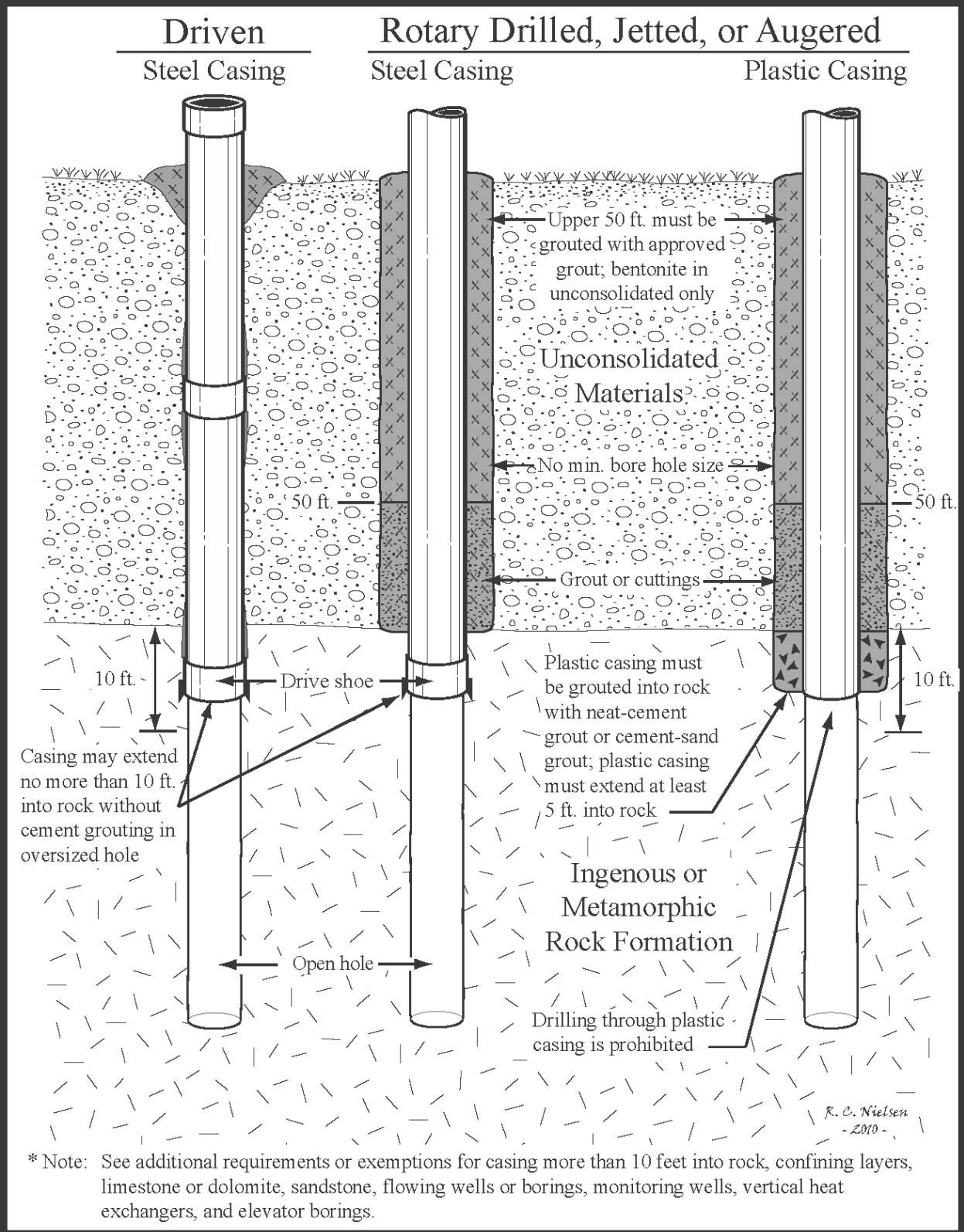

Figure 15. Wells and Borings in Rock With Casing Less Than 10 Feet Into Rock\*

*B. When the casing of a well or boring extends more than ten feet into bedrock, or extends through any portion of a bedrock confining layer, the casing must be installed in a bore hole 3.0 inches larger, or 3.5 inches larger for casings deeper than 100 feet and larger than 12 inches inside diameter, than the outside diameter of the casing or couplings, whichever is larger, and the annular space in bedrock must be grouted with neat-cement grout or cement-sand grout, except that steel casing may be driven more than ten feet in a sandstone formation.*

Steel casing may be driven **within** a sandstone formation to any depth without grouting. Driving casing in a sandstone (if the sandstone is the first rock unit) includes both driving the casing and drilling and driving the casing (drilling out ahead of the casing, by drilling through the casing, then driving the casing). A cone-shaped depression or temporary outer casing filled with bentonite as described in subpart 5 of this part is not required if the bore hole in the unconsolidated formation above the sandstone was drilled to produce an annular space and the annular space is grouted according to subparts 1 to 3 of this part.

A bore hole that is 3 inches (or 3.5 inches for 12-inch and larger casing) larger than the casing or couplings is often referred to as an “oversized” bore hole.



## Rotary Drilled, Jetted, or Augered Steel or Plastic Casing

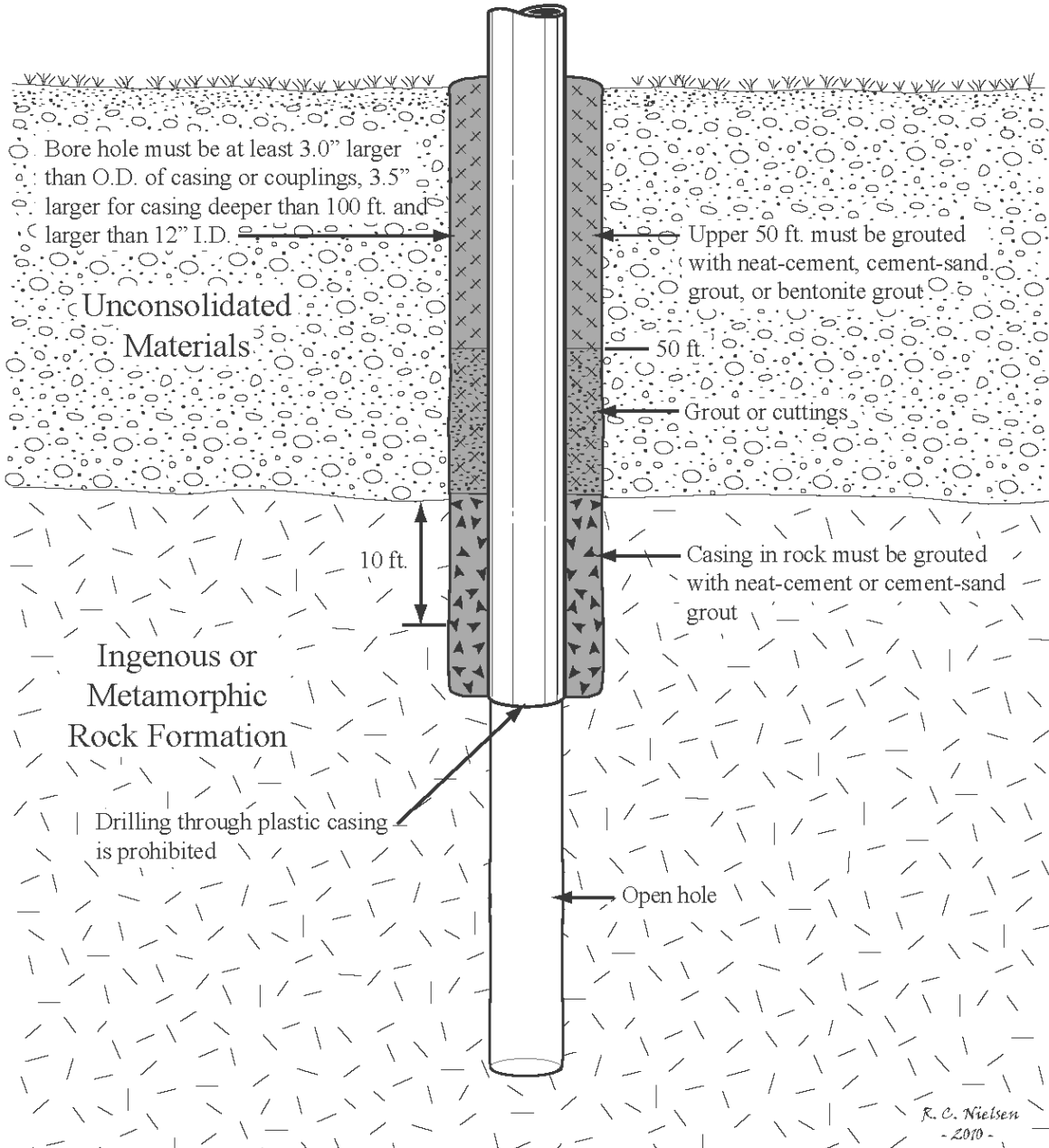

\* Note: See additional requirements or exemptions for confining layers, limestone or dolomite, sandstone, flowing wells and borings, dewatering wells, monitoring wells, vertical heat exchangers, and elevator borings.

Figure 16. Wells and Borings in Rock With Casing More Than 10 Feet Into Rock\*

Driven  
Steel Casing

Rotary Drilled, Jetted,  
or Augered  
Steel or Plastic Casing

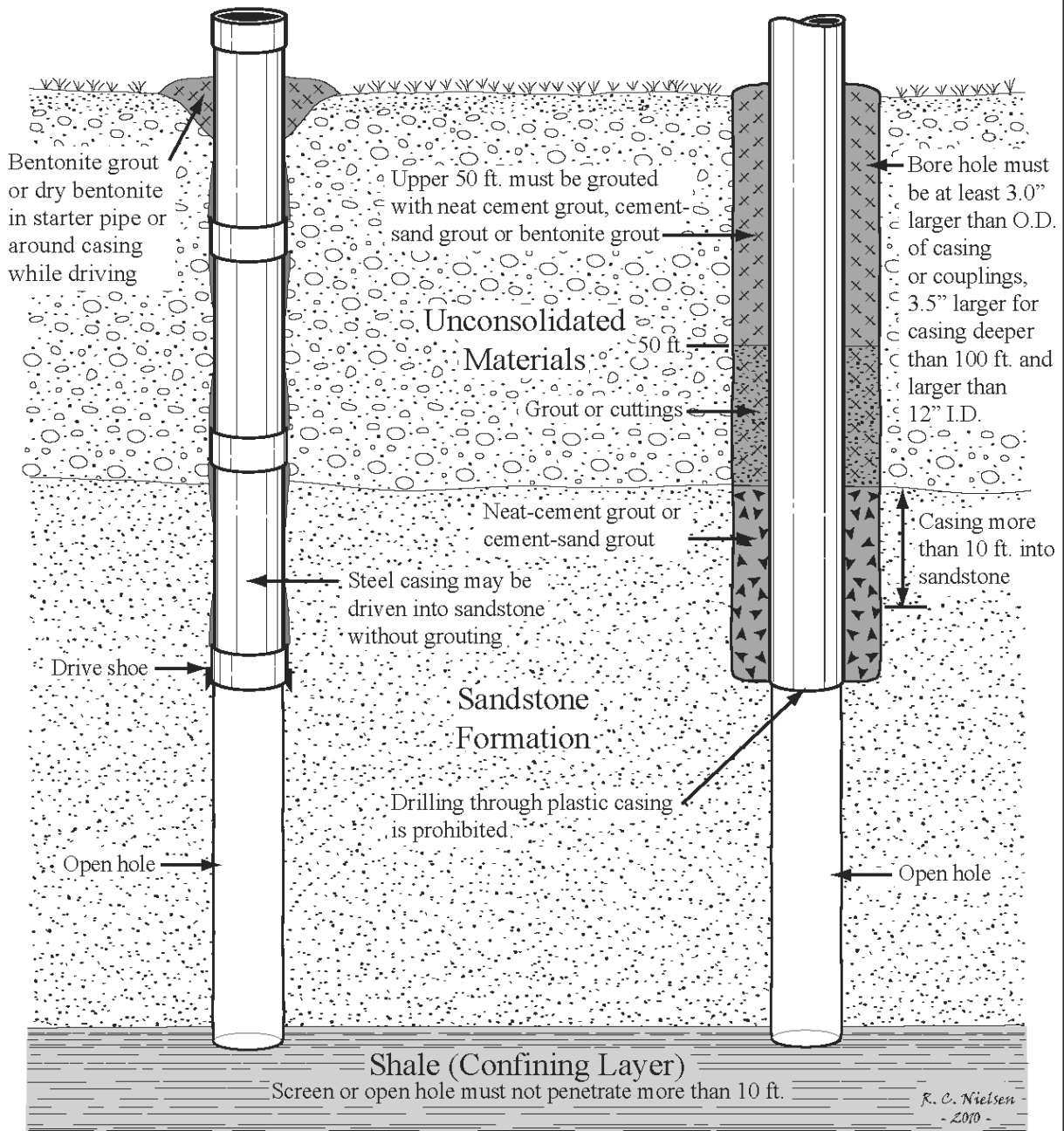

\* Note: See additional requirements or exemptions for confining layers, rock, limestone or dolomite, flowing wells and borings, dewatering wells, monitoring wells, vertical heat exchangers, and elevator borings.

Figure 17. Wells and Borings in Sandstone With Casing More Than 10 Feet Into Sandstone\*

## Rotary Drilled, Jetted, or Augered Steel or Plastic Casing

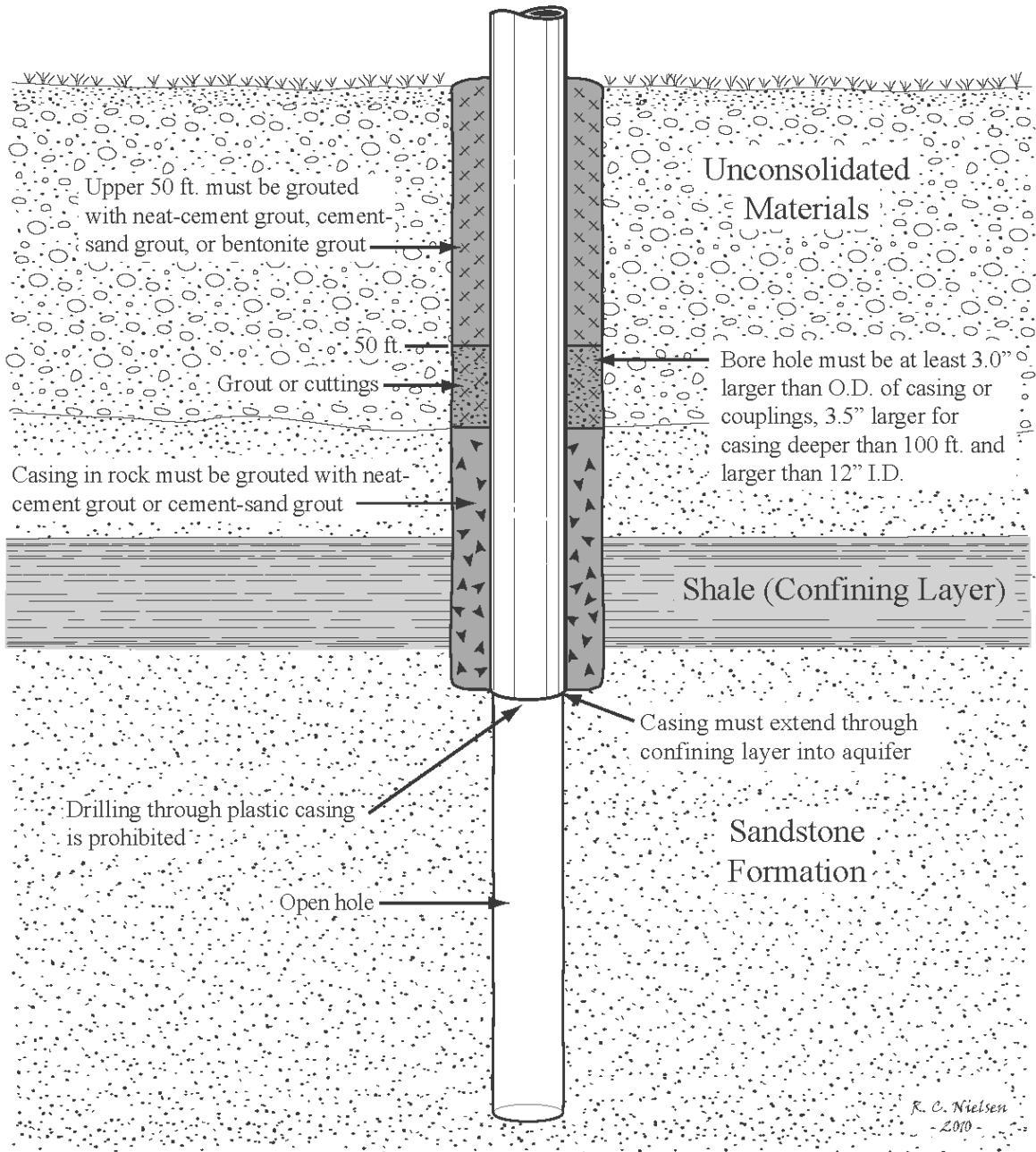

\* Note: See additional requirements or exemptions for confining layers, rock, limestone or dolomite, flowing wells and borings, dewatering wells, monitoring wells, vertical heat exchangers, and elevator borings.

Figure 18. Wells and Borings in Sandstone Below a Confining Layer\*

*C. If a cavern more than twice the diameter of the bore hole exists or the grout level fails to rise after insertion of either more than one cubic yard of grout or the quantity of grout necessary to fill ten vertical feet of hole, then the following grouting materials and methods may also be used in the portions where the conditions exist:*

This subpart concerns all rock wells or borings (not just water-supply wells), and addresses cases of large grout loss due to caverns, large fractures, or blasted and bailed portions.

*(1) pouring of a mixture of gravel or stone aggregate not larger than one-half inch in diameter while simultaneously pumping neat-cement grout or cement-sand grout through a tremie pipe in a ratio not to exceed five parts aggregate to one part grout;*

Aggregate must be poured into the annular space at a rate slow enough to prevent bridging. If bridging occurs, the bridged aggregate must be knocked loose before proceeding with grouting of the annular space.

*(2) pumping a mixture of gravel or stone aggregate not larger than one-half inch in diameter and cement-sand grout or neat-cement grout in a ratio not to exceed five parts gravel or aggregate to one part Portland cement; or*

*(3) pumping of alternate, equal thickness layers of cement-sand grout or neat-cement grout and pouring gravel or stone aggregate not larger than one-half inch in diameter. Individual layers of aggregate must not exceed ten feet in thickness. Aggregate must not be emplaced in a confining layer.*

*Neat-cement grout or cement-sand grout must be pumped through the casing or through a tremie pipe. The aggregate must be poured into the bore hole at a rate that prevents bridging.*

This allows three alternative methods for filling large voids when **one of three** conditions occurs. The three conditions are: (1) if there is a cavern more than twice the diameter of the bore hole, (2) if the grout level fails to rise after insertion of more than one cubic yard of grout, or (3) if the grout level fails to rise after the insertion of the quantity of grout necessary to fill 10-vertical feet of hole. The three alternative methods for filling these large voids include: (1) pouring aggregate (pearock) while pumping cement, (2) mixing aggregate with cement and pumping the mixture, and (3) grouting a 10-foot layer of cement followed by a 10-foot layer of aggregate. The alternate materials may only be used where there is grout loss or large openings as detailed above.

*Subp. 8. Bentonite seal between gravel pack and grout. A layer of bentonite pellets, bentonite chips, or granular bentonite not to exceed five feet in thickness, is allowed between a gravel pack and grout. The bentonite pellets, bentonite chips, or granular bentonite must not extend into a confining layer or extend more than ten feet above the static water level, and must be poured without voids or bridging. A*

*tremie pipe must be inserted to within ten feet of the top of the pellets, chips, or granular bentonite, and the annular space grouted to the established ground surface or base of the pitless unit or adapter.*

This allows a bentonite seal on top of gravel pack for any type of well or boring. Previously, it was allowed only for monitoring wells and environmental bore holes. This is designed to prevent migration of grout into the gravel pack or screen. As an alternative, some contractors use a thin layer of finer gravel pack or sand on top of the gravel pack.

## **GROUT SETTLEMENT**

A small amount of grout settlement is normal; however, MDH staff has documented excessive settlement problems with bentonite grout in annular seals, geothermal loop seals, and well and boring sealing – up to 90 percent settlement. Staff has seen heat loop borings drilled to 225 feet in which grout settled to 195 feet.

Manufacturers have told MDH that one-step, powdered bentonite grouts will settle 5 to 10 percent in an otherwise perfect hole – such as inside a well casing.

Some likely reasons for grout settlement include:

1. Using an inadequate grout product or mixture, must use a product manufactured for use as grout and mix this product in accordance with Minnesota Rules, Chapter 4725 and according to manufacturer specifications;
2. Poor mud wall or “filter cake” during drilling, cuttings and drill fluids trapped in washouts can mix with and dilute the grout;
3. An unstable grout “foundation,” settlement of cuttings or collapse of bridged material;
4. Geologic variability, porous & permeable formations like sand & gravel can absorb the water phase of a grout mixture before the bentonite hydrates . . . and an inadequate mud wall makes it worse; and
5. Channeling of grout, if drilling fluid in the annular space or bore hole weighs more than the grout, the result will be grout channeling – typically up along the tremie line, dilution of grout takes place and loss of water from the drilling fluid remaining in the bore hole, drilling fluid in the annular space or boring must be thinned prior to grouting to prevent channeling.

It appears that in general, the granular bentonite products do a better job than the one-step grout products. These products almost always need to be used with an additive to retard hydration. It’s very important not to over-mix grout. Mix only until the product is suspended, typically 15 to 60 seconds. The product should be lumpy and watery when pumped. Mix only enough to suspend the bentonite, and then pump. Let it hydrate in the hole.

Measure the exact amount of water needed for the product used. Mark this level on the shaft of the mixer, not the tank, which won’t be accurate if the grouter isn’t sitting level.

Water chemistry can have a big effect on grout performance. Soft water makes better grout. The hardness minerals calcium and magnesium retard bentonite hydration. Ideal make-up water should contain less than 100 mg/L calcium, have a pH between 8.5 and 9.5 (soda ash will correct hardness and adjust pH – usually only a few ounces of soda ash is all it takes to adjust the water for a batch of grout), and have less than 100 ppm chlorine. Test strips should be used to monitor the water chemistry.

Most pumps do a fair job pumping bentonite grout. One type of pump that doesn't work well with granular bentonite is the progressive cavity pump. These pumps cause excessive shear which results in almost-immediate hydration and that creates problems for pumping. Positive displacement pumps (piston pump) seem to be the most popular.

Don't thin the grout product to make it easier to pump. Don't add less than the correct amount of bentonite to the correct amount of water.

If you're having trouble pumping grout consider these problem areas:

- Mixing too long, delaying pumping;
- Shearing the product by using the wrong pump;
- Too small diameter of tremie line;
- Too much tremie line on the reel or on the ground;
- Splices, obstructions, or reductions in the pump discharge or tremie line; and
- Failure to run clean water through tremie line just prior to beginning to pump grout.

Successful Grouting tips:

- Drill a stable bore hole and try to avoid washouts.
- Thin down drilling fluid to help reduce channeling.
- Add cuttings slowly to avoid bridging, or consider full-length grouting.
- If using bentonite, use a granular bentonite product mixed to label requirements – at least 15 percent solids.
- Get the tremie all the way to the bottom and keep it submerged while pumping.
- Pump the bentonite grout fast to induce turbulent flow to remove drilling fluids.
- Use the largest tremie line possible.
- Drill a hole big enough to allow a tremie pipe that's big enough.
- Pump water through a tremie pipe prior to grouting. This does several things:
  - It cools the black poly down, which might be important if it's been out in the sun because heat speeds grout hydration;
  - It lubricates the inside of tremie; and
  - It verifies that the tremie isn't plugged.
- Use a rigid tailpipe if a flexible tremie pipe is used with the end cut at angle to help get past couplings or rocks, and drill holes in the side of the tremie near the bottom, just in case the bottom gets plugged.
- Remember: warm water speeds hydration.
- Pump until quality grout returns to surface.
- Save excess grout to top-off tremie displacement or settlement (Minnesota Rules, Chapter 4725 allows grout to be poured 10 feet – so keeping some on hand in a bucket lets you continue to top-off settling grout).
- The weight of the grout column can be very significant, particularly in deep wells or borings or where the static water level is low. Grouting in stages which allows the lifts to set before placing more grout, can sometimes reduce the settlement.
- Pump the grout at rates high enough to cause turbulent flow which removes drilling mud and cuttings left in the hole.

## **CONFINING LAYERS**

In cases where the first bedrock encountered is one of the bedrock-confining layers (the Decorah, Glenwood, St. Lawrence, or Eau Claire confining layers) the well or boring may only be open to the formation for 10 feet (St. Lawrence or Eau Claire) or 2 feet (Decorah or Glenwood), and the well or boring may not be open to the underlying formation. If the well or boring is going to use an underlying formation, a bore hole 3.0 inches (3.5 for 12 inches and larger casings deeper than 100 feet) larger than the casing or coupling outside diameter must be drilled through the bedrock-confining layer and the annular space in the bedrock portion of the well must be grouted with neat-cement grout or cement-sand grout.

## **STEEL CASING**

Steel casing equipped with a drive shoe may be driven into bedrock a maximum of 10 feet without drilling an oversized hole. If sandstone is the first bedrock unit, see subitem B above.

Steel casing without a drive shoe must be grouted with neat-cement or cement-sand grout for the entire length of casing in bedrock. If the casing extends more than 10 feet into rock, an oversized bore hole is required.

## **PLASTIC CASING**

Plastic casing must be cement grouted into bedrock. Plastic casing may not extend more than 5 feet into limestone or dolomite. Plastic casing must not be driven (Minnesota Rules, part 4725.2650). If the casing is installed more than 10 feet into bedrock, an oversized bore hole must be drilled.

## **SCREENING A CONTACT**

In some environmental contamination situations, it may be necessary to monitor or remediate across the contact between an unconsolidated formation and bedrock. This typically involves gasoline or other hydrocarbons floating on the water surface which is near the drift/rock contact. Rules addressing this for remedial wells, monitoring wells, and environmental bore holes are contained in Minnesota Rules, parts 4725.6050, 4725.6650 and 4725.7450 respectively.

## **SUMMARY – GROUTING IS REQUIRED**

### **CONFINING LAYERS.**

- For any well or boring penetrating a bedrock confining layer.

### **MULTIPLE CASINGS.**

- When an inner casing is placed inside an outer casing. The outer casing must be 3.0 (or 3.5 for 12-inch and larger casing) larger than the inner casing. Neat-cement grout or cement-sand grout must be used.

#### UNCONSOLIDATED FORMATIONS.

- For any well or boring drilled with a method which creates an annular space, from a depth of at least 50 feet or from the top of the gravel pack, whichever is less. A minimum bore hole size is not required. Bentonite grout, neat-cement grout, or cement-sand grout may be used in unconsolidated formations.
- When an annular space in unconsolidated formations below 50 feet is not filled with cuttings. A minimum bore hole size is not required. Bentonite grout, neat-cement grout, or cement-sand grout may be used in unconsolidated formations.

#### BEDROCK.

- For any well or boring with a bore hole larger than the casing O.D., and with casing more than 10 feet into bedrock. The top 50 feet must be grouted as explained above. The bedrock portion must be grouted with neat-cement grout or cement-sand grout. The bore hole in bedrock must be oversized.\*
- For any plastic cased well, whether screened or open hole, in bedrock. The casing must extend a minimum of 5 feet into bedrock except that the casing must not extend more than 5 feet into limestone or dolomite. The bedrock portion must be grouted with neat-cement grout or cement-sand grout.
- For any steel cased well or boring finished in bedrock which does not have a drive shoe.

#### FLOWING WELLS AND BORINGS.

- For any well or boring which flows less than 70 g.p.m. or has less than 10 psi which is drilled by rotary, jetting, auger, or similar method. Neat-cement grout or cement-sand grout must be used.
- For any well or boring flowing more than 70 g.p.m. or which has more than 10 psi. Neat-cement grout or cement-sand grout must be used.

#### LIMESTONE OR DOLOMITE.

- For any water-supply well completed below limestone or dolomite that does not have 50 feet of surficial materials. The outer casing must be 3.0 (or 3.5 for 12-inch and larger casing) larger than the inner casing. Neat-cement grout or cement-sand grout must be used.
- For any water-supply well completed in limestone or dolomite if the static water level is less than 10 feet below the top of the limestone. The bore hole must be oversized. Neat-cement grout or cement-sand grout must be used.

#### MONITORING WELLS, ENVIRONMENTAL BORE HOLES, VERTICAL HEAT EXCHANGERS.

- For any monitoring well or cased environmental bore hole from the top of the gravel pack/bentonite seal or bottom of the casing to the surface; and
- For the entire depth of any vertical heat exchanger.

\* An “oversized bore hole” is a drill hole that is 3.0 inches larger than the outside diameter of the casing, coupling, or bell end, whichever is larger; or 3.5 inches larger than the outside diameter of the casing, coupling, or bell end for casings 12 inches and larger and deeper than 100 feet.

*STAT AUTH: MS s 103I.101; 103I.111; 103I.205; 103I.221; 103I.301; 103I.401; 103I.451; 103I.501; 103I.525; 103I.531; 103I.535; 103I.541; 103I.621; 144.05; 144.12; 144.383; 157.04; 157.08; 157.09; 157.13*  
*HIST: 17 SR 2773; 33 SR 211*

*4725.3100 [Repealed, 17 SR 2773]*



**End  
of  
Grouting Section**

### **4725.3150 CASING CONNECTIONS AND CAPS.**

This part applies to all wells and borings. Water-supply wells have more stringent standards for connections to a well casing and are located in Minnesota Rules, parts 4725.4850 and 4725.5450. Minnesota Rules, part 4725.4850 concerns pitless units, pitless adapters, and welded or threaded fittings; and Minnesota Rules, part 4725.5450 requires a screened, down-turned **vent** on water-supply wells. The rules do not require a vent on wells or borings other than water-supply wells, however, vents are recommended on wells with pumps. Vents may be installed on wells or borings, but the vent must comply with the standards of Minnesota Rules, part 4725.5450. The practice of drilling a hole through the casing and protective-outer casing to “vent” a well, such as a monitoring well, is not an approved practice.

Components which replace a portion of the casing above 12 inches such as a “T” or coupling must be materials meeting, or equivalent to, the casing standards.

*Subpart 1. Casing connections and caps 12 inches above ground. A connection or fitting 12 inches or more above the established ground surface into the top or side of a casing must be constructed to be weatherproof and insect proof. The connection, including a cap, cover, electrical connection, water treatment connection, discharge piping, vent, access pipe, or other connection to the casing must consist of:*

- A. a threaded connection;*
- B. a welded or solvent welded connection;*
- C. a rubber expansion sealer;*
- D. a bolted flange with rubber gasket;*
- E. an overlapping cap or cover with compression gasket;*
- F. an extension of the casing at least one inch into the base of a pump; or*
- G. a sanitary well seal with a one-piece top plate, compression gasket, and noncorrodible draw bolts. The cap or seal must be equivalent to the casing in weight and strength. If the well or boring is in a building that meets the requirements in part 4725.2175, a two-piece top plate, compression gasket, and noncorrodible draw bolts may be used.*

Minnesota Rules, part 4725.2175 requires that a well or boring **must not be within a building** unless the building (well house) meets all requirements of Minnesota Rules, part 4724.2175. Subpart G requires a sanitary seal installed outdoors to have a one-piece top plate.

The casing connection requirements of this part apply to the well or boring at completion. Minnesota Rules, part 4725.2250, subpart 16, requires the casing to be **temporarily covered** by one of the methods listed, during the construction process when actual construction is not occurring. The temporary cover must be weatherproof and insect proof. Tape, bags, upside down buckets, rags, plastic sheeting, and boards are unacceptable temporary covers.

Special concern should be taken to ensure that electrical connections are weatherproof and insect proof as described in subpart 3 below.

**Subp. 2. Casing connections less than 12 inches above ground.** A connection to, or a fitting on a casing made less than 12 inches above the established ground surface must be constructed to be watertight, vermin proof, and provide complete clearance within the internal diameter of the casing. The connection must not be submerged in water at the time of installation. The connection must be made at or above the frost line. The connection or fitting must consist of a:

A. threaded connection equivalent to the material and threading standards of ASTM A53/A53M-04a, ASTM A589-96 (2001), API Standard 5L-04, ASTM A312/A312M-04b, or ASTM F480-02;

B. welded connection for steel or stainless steel casing where:

(1) the welded fitting must:

(a) be made of forged or machined metal; a cast-iron fitting is not allowed;

(b) be certified for use with pressure rated vessels or piping;

(c) be marked with the design pressure rating and manufacturer;

(d) be made of metal compatible with the casing material;

(e) have a design pressure rating equal to or greater than the casing;

(f) fully integrate branch reinforcement and maintain full casing strength by providing casing reinforcement, with reinforcement tapering at the sides of the fitting;

(g) have a contour matching the curvature of the casing; and

(h) be self aligning;

(2) the installer of a welded fitting must:

(a) complete the weld free of slag, inclusions, bubbles, voids or other imperfections;

(b) use a guide or template for cutting the hole in the casing, or use a properly sized drilled hole;

(c) install the welded fitting in accordance with the manufacturers recommendations; and

(d) field weld the fitting by holding the welding rod in a vertical or horizontal position, or bench-weld the fitting before field installation, with a welding rod as corrosion-resistant as the casing;

C. solvent welded connection for plastic casing equivalent to the standards of ASTM F-480-02, or part 4725.2550;

D. bolted sleeve-type coupling meeting ANSI/AWWA Standard C219-01 where:

(1) the bolted sleeve-type coupling must:

(a) have a working pressure rating of at least 150 pounds per square inch;

(b) have an interior coating that complies with ANSI/NSF Standard 61-2003e if the coupling has an interior coating in contact with water; and

(c) provide for the casing or pipe to extend at least 2.5 inches into the coupling;

*(2) the installer of a bolted sleeve-type coupling must:*

*(a) install the coupling in accordance with ANSI/AWWA Standard C219-01;*

*and*

*(b) insert the casing or pipe ends at least 2.5 inches into the coupling;*

*E. pitless adapter or pitless unit meeting the requirements of part 4725.4850, subpart 1.*

*A welded, solvent welded, or threaded coupling, adapter, or swaged fitting meeting the material standards of part 4725.2350, 4725.2550, or 4725.6650, may be used to connect a casing to a pitless adapter or unit.*

Item A references the ASTM and API casing standards.

Item B describes manufactured fittings such as a “Weld-O-Let” or “Thread-O-Let” fitting.

Item C references the plastic casing standards of ASTM F480-02, and Minnesota Rules, part 4725.2550 refers to the plastic well casing specifications and requirements in rule.

Item D refers to specifications of “Dresser”-type couplings. NSF Standard 61-2003e refers to standards for drinking water system components.

Item E refers to the pitless adapter and pitless unit specifications. The specifications for pitless adapters and units are located in Minnesota Rules, part 4725.4850. A list of pitless units and adapters that meet the standard is included in the appendix.

Minnesota Rules, part 4725.2350 refers to the steel casing requirements; Minnesota Rules, part 4725.2550 refers to the plastic casing and coupling requirements; and Minnesota Rules, part 4725.6650 refers to the flush threaded PVC and stainless steel monitoring well casing standards.

Connections to environmental bore holes, vent/sparge systems, and multiple-use wells and borings present practical problems because of small-casing diameters and multiple-exit ports. While the rules allow numerous types of underground connections, it is recommended that a pitless adapter or pitless unit(s) be used whenever possible. Multiple pitless adapters can be installed by offsetting the discharges at different heights. **If a pitless is not used, a connection to the casing must be made with a manufactured fitting which meets the requirements listed above.** The practice of torch cutting a hole in the casing, sticking a pipe through the hole, and attempting to weld the connection watertight is not approved.

The rules require that any underground connection made to the casing of a well or boring must be watertight. The connection must consist of a threaded connection, welded connection, solvent-welded, bolted sleeve-type coupling, or pitless adapter or unit. The rule is more restrictive for water-supply wells (including remedial wells); only a pitless adapter or unit is allowed for the water discharge line.

The watertight requirement applies to any connection including discharge connections, vacuum lines, and electrical connections.

*Subp. 3. **Electrical connections.** Electrical wire must enter a casing, cap, cover, or pump base a minimum of 12 inches above the established ground surface except for a well or boring completed at-grade in accordance with part 4725.6850. Electrical wires above the ground surface must be contained within a conduit or the casing. The electrical wire connection through the casing, cap, cover, or pump base must be made watertight and vermin proof with a compression fitting, gasket, or electrical conduit installed in accordance with Minnesota Statutes, section 326.243, or caulk meeting the standards of ANSI/NSF standard 14-2003, or 61-2003e.*

Special emphasis should be placed on electrical wires. Unprotected openings for electrical wires can allow rodents or insects, such as Asian beetles or earwigs, to enter the well or boring.

*STAT AUTH: MS s 103I.101; 103I.111; 103I.205; 103I.221; 103I.301; 103I.401; 103I.451; 103I.501; 103I.525; 103I.531; 103I.535; 103I.541; 103I.621; 144.05; 144.12; 144.383; 157.04; 157.08; 157.09; 157.13*

*HIST: 17 SR 2773; 33 SR 211*

**4725.3200 [Repealed, 17 SR 2773]**

### **4725.3250 PUMPS AND PUMPING EQUIPMENT.**

*A pump or pump base installed on a well must be constructed so no unprotected openings exist into the interior of the pump or well casing.*

*A. A hand pump, hand pump head, stand, or similar device must have a closed and screened spout, directed downward. The pump must have a concrete slab at least four inches thick extending horizontally at least one foot in every direction from the well casing and sloped to divert water away from the casing. A watertight seal must be provided between the casing and the slab.*

The watertight seal may be a gasket or nontoxic caulk such as silicone.

*B. A reciprocating pump rod must operate through a stuffing box, packing gland, or other watertight and vermin proof fitting.*

Typical **pitcher pumps** do not have a stuffing box or packing gland. Pitcher pumps usually do not meet the requirements of this rule. Rotary-type hand pumps must be sealed to prevent rain, animal feces, insects, or other foreign materials from entering the well.

*C. An oil lubricated vertical turbine pump must not be installed in a well.*

An oil-lubricated turbine pump must not be installed in a new well or an existing well.

An oil-lubricated vertical-turbine pump presently in operation in a well is not required to be replaced with a nonoil-lubricated pump if the pump is still in operation; however, replacement is recommended. An oil-lubricated turbine may be removed from an existing well, repaired, and reinstalled in the well as long as the repair involves replacement of less than 50 percent of the pump. Repair includes replacement of pump column, bowls, shaft, or motor, but does not include replacement of the oil tube. If the repair involves more than 50 percent of the pump, the oil-lubricated pump may not be reinstalled.

*D. A water lubricated vertical turbine pump must be lubricated with water from the well or a potable source.*

*STAT AUTH: MS s 103I.101; 103I.111; 103I.205; 103I.221; 103I.301; 103I.401; 103I.451; 103I.501; 103I.525; 103I.531; 103I.535; 103I.541; 103I.621; 144.05; 144.12; 144.383; 157.04; 157.08; 157.09; 157.13*

*HIST: 17 SR 2773; 33 SR 211*

**4725.3300** [Repealed, 17 SR 2773]

#### **4725.3350 INTERCONNECTIONS AND CROSS CONNECTIONS.**

*No connection between a well or boring and another well, boring, water supply system, or contamination source is allowed unless the connection is:*

*A. protected by an air gap as described in part 4715.2010;*

The Minnesota Plumbing Code, part 4715.2010, specifies how the minimum air gap is measured, the minimum air gap distance based on the outlet size, and the effect of obstructions. An air gap is a physical separation of an influent pipe (generally a potable water pipe, faucet, or outlet) and a receiving tank, sewer, or pipe. The minimum air gap or separation is twice the influent pipe diameter. Refer to the appendix for Minnesota Plumbing Code, part 4715.2010.

*B. protected with a backflow prevention device as specified in parts 4715.2020 to 4715.2170;*

A **backflow prevention device** is an assembly of valves, ports, and other flow-regulating devices intended to prevent a contaminant or potential contaminant from flowing into piping where it is not intended.

**Backflow** means the unintended flow of water or other liquids, chemicals, or contaminants into a potable water system, well, or boring. Backpressure and backsiphonage are two types of backflow. Backflow due to backpressure occurs when the contaminant is at a higher pressure than the potable water system. Backflow due to backsiphonage occurs when the potable water line is below atmospheric pressure.

**Cross connections** are any connections between a potable water supply (including a well, boring, or groundwater) and a fixture, tank, receptacle, or other equipment through which contaminants may enter the potable water system. A cross connection may be as simple and obvious as a chemical feed pipe

connected directly to a potable water pipe, or as complicated and difficult to locate as a single improper solenoid valve in a large manufacturing plant. Cross connections occur when systems, devices, or equipment containing potential contaminants are interconnected with an unprotected potable water system.

Numerous cases of cross connections with resultant illness have been reported in the literature. In Minnesota within the last few years; atrazine, sewage, antifreeze, solvents, and even propane have contaminated public water supplies through cross connections.

The **Minnesota Plumbing Code**, parts 4715.2020 to 4715.2170 outline the requirements for the protection of potable water against backflow. Backflow prevention assemblies, devices, and methods include: air gaps, Atmospheric Vacuum Breakers (AVB), Pressure Vacuum Breakers (PVB), hose connection vacuum breakers (Hose VB), double-check valve with intermediate atmospheric vents (DCVIAV), RPZ, and double-check valve assemblies (DCVA). Refer to the appendix for Minnesota Plumbing Code, parts 4715.2020 to 4715.2170.

The backflow prevention assemblies, devices, and methods are listed in the Minnesota Plumbing Code. A brief description follows:

### **BACKFLOW PREVENTION DEVICES**

**AIR GAP.** An air gap is a physical separation between a potable water system and potential contaminants. An example of an air gap is a common sink, where the potable water supply pipe (in this case the faucet) is above the flood rim (over-flow level) of the basin. An air gap must be at least twice as high as the inside diameter of the supply pipe. An air gap is simple, inexpensive, and is acceptable for use with direct or indirect connections and all hazards.

**REDUCED PRESSURE ZONE BACKFLOW PREVENTER (RPZ).** A RPZ is a manufactured assembly consisting of two positive-seating check valves located on either side of a pressure differential relief valve, with shut-off valves on each end. The assembly must have test ports and must be inspected annually and overhauled every five years. Reduced pressure zone backflow preventers may be used where back pressure and continuous line pressure exist and where the potential contaminants are hazardous.

**DOUBLE CHECK VALVE WITH INTERMEDIATE ATMOSPHERIC VENT (DCVIAV).** This device consists of an atmospheric vent located between two independently operating check valves. The device is used for low or moderate hazards with small pipe sizes under back pressure and continuous line pressure. Typical applications are direct connections between a potable water supply and a nontoxic nuisance or aesthetically unpleasant source such as a swimming pool or food or beverage equipment.

**DOUBLE CHECK VALVE ASSEMBLY (DCVA).** This assembly has two independent positive-seating check valves with shut-off valves on each end and four test ports. The assembly is used for low hazard nuisance or aesthetic concerns.

**PRESSURE VACUUM BREAKER (PVB).** This assembly consists of an inlet and outlet shut off, one or more check valves, an air inlet valve, and test ports. It is used where back pressure does not occur but continuous line pressure does occur. The assembly must be installed 12 inches above the spill line or the highest outlet downstream of the assembly. Typical applications include process tanks, laundries, and lab equipment.

**ATMOSPHERIC VACUUM BREAKER (AVB).** This device includes an air-inlet valve open to the atmosphere when the pressure in the line drops to atmospheric. The device is used where no back pressure exists and cannot be used under continuous pressure. The device must be installed on the discharge side of the last control valve and must be a minimum of 6 inches above the spill line or the highest elevation of any line downstream of the device. Applications include lab faucets, cooling towers, and hose bibs.

None of the backflow prevention devices listed above can be buried.

Permissible backflow prevention devices for connection of two wells (except public supply wells), one meeting the rule standards and the other constructed before 1974 and not meeting the standards, or two wells in different aquifers, are a double check valve assembly with intermediate atmospheric vent, reduced pressure zone backflow preventer assembly, or double check valve assembly. It should be noted that if the two wells are manifolded into a common header, a backflow prevention device is required on each well. It should also be noted that a double check valve assembly is not just two separate check valves, it is a manufactured assembly.

The only backflow protection device permitted for interconnection with a public supply is an RPZ, which requires approval of the administrative authority, yearly testing, and rebuilding every five years.

*C. protected with a back flow prevention device as specified in parts 1505.2100 to 1505.2800 if the well is an irrigation well used for chemigation; or*

**Chemigation** is the process of applying agricultural chemicals (fertilizers, pesticides, plant amendments, or soil amendments) through an irrigation system. MDA Rules, parts 1505.2100 to 1505.2800, became effective on January 1, 1994. Rules describing the backflow prevention devices are contained in MDA Rules, part 1505.2300, subpart 3, which is included in the appendix. A summary of the rule follows. The rule should be consulted for details and additional requirements.

### **CHEMIGATION RULES SUMMARY**

- Chemigation systems must have antipollution devices.
- A mainline irrigation system supply must have a reduced pressure zone backflow preventer or two check valves in series for systems directly connected to a water supply, which must be located in the irrigation system supply pipeline between the irrigation system water supply pump or source of irrigation water and the point of injection of the agricultural chemical.
- A single mainline check valve may be used for the application of fertilizer.
- A reduced pressure zone backflow preventer must be used when the source of irrigation water is potable water.
- If a single irrigation system supply check valve or two irrigation system supply check valves in series are used, each check valve must be equipped with an inspection port or a similar device and be immediately preceded in the irrigation system by a vacuum relief valve and automatic low-pressure drain valve.
- An injection line check valve that is resistant to agricultural chemicals must be provided on the agricultural chemical injection line between the point of agricultural chemical injection into the irrigation system and the agricultural chemical injection unit, pump, or solution tank.
- An interlock, such as electrical, pressure, mechanical, or water motor, must be provided between the irrigation system or water pump and the agricultural chemical injection unit.
- A low-pressure shutdown device must be used.



*D. between wells or borings that meet the construction standards of this chapter, are used for the same purpose, and have equivalent water quality.*

The discharge lines from two wells may be manifolded together without backflow protection if both wells meet the standards of the rules, are completed in the same aquifer, and if the water quality in the wells is the same (within normal natural variations). If one or both wells do not meet the construction standards of this chapter, are used for different purposes or have different water quality, the discharge line from both wells must be protected with backflow protection.

*This part does not apply to a water distribution system after the pressure tank; however, this part does not exempt water distribution systems otherwise regulated by chapter 4715.*

The DLI licenses plumbers and administers the Minnesota Plumbing Code, Minnesota Rules, Chapter 4715. The Minnesota Plumbing Code is adopted, amended, and interpreted by the Minnesota Plumbing Board. A plumbing license and plumbing bond are required statewide to contract for plumbing in Minnesota. The Minnesota Plumbing Code historically applied only to public facilities and where it or the Minnesota Building Code was adopted. According to DLI, recent law changes extend the Plumbing Code statewide. The well and boring rules do not exempt anyone from following (more restrictive) standards of the Minnesota Plumbing Code.

#### **BACKFLOW PREVENTION FOR FILLING A POND**

A well used to fill a pond must be protected from backflow. Acceptable methods include an air gap or a RPZ. An air gap provides the simplest, cheapest, and safest protection. Where there is no backpressure (no valves downstream) an AVB may be used as long as it is at least 6 inches above the pond spill line. A PVB may be used if it is at least 12 inches above the spill line. A spill-proof PVB may be used if it is at least 6 inches above the pond spill line. The spill proof types are commonly used inside a building since they don't normally drip water. A backflow device may not be buried or in a pit.

*STAT AUTH: MS s 103I.101; 103I.111; 103I.205; 103I.221; 103I.301; 103I.401; 103I.451; 103I.501; 103I.525; 103I.531; 103I.535; 103I.541; 103I.621; 144.05; 144.12; 144.383; 157.04; 157.08; 157.09; 157.13*

*HIST: 17 SR 2773; 18 SR 1222; 33 SR 211*

***4725.3400 [Repealed, 17 SR 2773]***

## **4725.3450 FLOWING WELL OR BORING.**

Flowing wells and borings are drill holes where the pressure in the aquifer is sufficient to force water above the ground surface, so that water will flow without pumping. Flowing conditions typically occur at lower elevations in groundwater discharge areas near rivers, lakes, or other water bodies. The most common example of a flowing artesian aquifer consists of a low permeability confining layer, such as clay or shale, which overlies the flowing aquifer. However, under some circumstances the presence of faults, fractures, or solution cavities can cause a drill hole to flow. Also, flowing wells or borings can occur without the presence of a distinct confining layer, near discharge areas, usually very near rivers. In these cases, a drill hole can provide a vertical pathway through sediments that normally transmit water better in a horizontal direction than a vertical direction.

*Subpart 1. General construction; flowing well or boring. A well or boring from which groundwater flows above the established ground surface without pumping must be constructed to prevent erosion of the aquifer and the confining layer. Casing must be installed into the flowing aquifer to prevent water flowing up the outside of the casing. The requirements in this part are in addition to other requirements of this chapter.*

The purposes of these requirements are to contain the flowing groundwater within the well or boring casing and to protect and conserve the groundwater resource. Flow outside the casing may result erosion of the confining layer(s), subsidence of overlying formation(s), and eventually uncontrolled flow. Flowing wells and borings have caused drilling machines to tip over, caused significant damage to property and structures, created serious safety threats, and accelerated aquifer dewatering.

Shallow, high flow wells deserve special caution. It is very important not to erode the confining layer. Large diameter grout pipes and high volume grout pumps may be needed. The contractor should be prepared **prior** to starting drilling in an area likely to have flowing conditions. Adequate equipment, casings, grout, and personnel should be available. A well or boring should not be left uncontrolled in the hope that conditions will stabilize later. This rarely happens, and usually creates much greater problems.

These requirements apply when the well or boring will **flow at the land surface**, even if the casing is extended above the artesian head, or a device installed to reduce the flow. Subpart 1a. applies to flows less than 70 gallons per minute or pressures less than 10 pounds per square inch measured at the land surface. Subpart 2 applies to flows greater of 70 gallons per minute or greater, pressures of 10 pounds per square inch or greater, or in flowing well and boring special construction areas. In numerous instances, particularly as flow rates approach 70 gallons per minute or pressures approach 10 pounds per square inch, it is safer to follow the standards of subpart 2 (install an outer casing and cement) even though it is not required.

A cross-sectional geological diagram depicting confining layers and artesian conditions is located after the definition of “confining layer” in Minnesota Rules, part 4725.0100.

*Subp. 1a. Low flow and low pressure. A flowing well or boring that flows 70 gallons per minute or less, and that has an artesian pressure ten pounds per square inch or less, must be constructed by either:*

*A. drilling a bore hole larger than the casing into the flowing aquifer, installing*

*casing into the flowing aquifer, and grouting the annular space surrounding the casing with neat-cement grout or cement-sand grout from the bottom of the casing to the base of the pitless adapter or unit, or to the established ground surface according to part 4725.3050; or*

*B. driving steel casing with welded, or threaded and coupled joints, into the flowing aquifer.*

**Driven steel casing** with welded or threaded and coupled joints is exempt from the cement grout requirement described in subpart 1a, for wells and borings flowing less than 70 gallons per minute, having a head less than 10 pounds per square inch, or not located in a flowing well or boring special construction area.

The low-flow or low-pressure wells or borings do not require a **minimum bore hole size**. However, annular space must be grouted with neat-cement or cement-sand grout from the bottom of the casing. In many cases it may be prudent to drill a hole large enough to install a larger tremie pipe. Problems have been encountered attempting to place cement grout in flowing wells through small-diameter grout pipes with low flow pumps if the grout cannot be emplaced fast enough to overcome the water flow rate out of the hole. Contractors have reported that thicker cement grout (5.2 gallons of water per 94 lb. of Portland cement) or rapid-setting cement (high early) can be beneficial in grouting some flows.

Placing a screen or gravel pack within the confining layer is not allowed.

In some instances of low flow, it may be possible to raise the ground elevation around the casing to prevent flow and make service and installation of the discharge easier.

The flow rate and the pressure are measured at the established ground surface, not at the top of the casing. The flow rate and pressure conditions apply at the time the well or boring is placed in service. Under certain conditions, a well may begin to flow only after drilling fluids are removed and/or well development takes place. Contractors should carefully measure the flow rate and pressure.

***Subp. 2. High flow, high pressure, or special construction area.***

*A. A well or boring must be constructed according to the requirements in this subpart when:*

*(1) the artesian flow rate at the established ground surface is greater than 70 gallons per minute;*

*(2) the artesian pressure at the established ground surface exceeds ten pounds per square inch; or*

*(3) the commissioner designates an area where the use of standard construction techniques have resulted in uncontrolled flows, or where hydrogeologic conditions such as eroded or unstable confining layers require special construction to successfully complete a well or boring and confine the artesian pressure.*

*B. A well or boring meeting the criteria in A must be constructed by:*

*(1) installing an outer steel casing into, but not through the confining layer overlaying the flowing aquifer, except that the outer casing may terminate in*

*competent bedrock above the confining layer. The outer steel casing is not required to meet the material specifications for casing in part 4725.2350 if the casing is of sufficient strength to withstand the structural load imposed by conditions both inside and outside the well or boring. The casing must be installed by drilling a bore hole a minimum of 3.0 inches larger, or 3.5 inches larger for casings deeper than 100 feet and larger than 12 inches inside diameter, than the outside diameter of the casing or couplings, whichever is larger, into the confining layer overlying the flowing aquifer. The bore hole must not penetrate the entire thickness of the confining layer. Steel casing must be installed into the confining layer; and neat-cement grout or cement-sand grout must be pumped into the annular space surrounding the casing from the bottom of the casing to the established ground surface or base of the pitless adapter or unit;*

*(2) drilling a bore hole a minimum of 3.0 inches larger, or 3.5 inches larger for casings deeper than 100 feet and larger than 12 inches inside diameter, than the outside diameter of the inner casing or couplings through the confining layer into the flowing aquifer;*

*(3) installing an inner casing into the flowing aquifer in accordance with part 4725.2250, subpart 8; and*

*(4) grouting the annular space surrounding the inner casing with neat-cement grout or cement-sand grout from the bottom of the casing to the established ground surface or base of the pitless adapter or unit.*

*Grouting must comply with part 4725.3050.*

The designated areas are known as “**Flowing Well or Boring Special Construction Areas**” and will be established by the MDH when necessary. Maps showing flowing well and boring areas will be provided to contractors as they become available. At the present time, only one such area, located near Kabekona and Benedict Lakes in Hubbard County, has been designated.

Wells and borings which exceed the flow rate or pressure, or are in special construction areas must be double cased and double grouted using either neat-cement or cement-sand grout.

It is extremely important that the outer casing be firmly sealed into the **confining layer**. The drill hole must not penetrate all the way through the confining layer. Ideally, the casing should be set approximately one-half way into the confining layer. The outer casing may terminate in a “competent bedrock” above the confining layer – this applies only to formations meeting the definition of “bedrock” found in Minnesota Rules, part 4725.0100, subpart 21b, and does not include alluvium, glacial drift, glacial outwash, glacial till, saprolite, or soil.

The outer casing must be steel, but does not need to meet the casing standards; it may be used, nonprime, or “light-weight” pipe. It may not be plastic. The inner casing may be steel, plastic, or stainless steel meeting the specifications of the rules (Minnesota Rules, part 4725.2250).

The neat-cement or sand-cement grout must be pumped through the casing or a tremie pipe.

After grouting the outer casing, drilling may not be done for 24 hours (12 hours if rapid-setting cement is used) to allow time for the cement to set. Refer to Minnesota Rules, part 4725.3050, for more information on grouting.

The inner casing must be cement grouted from the bottom of the casing (which is installed into the flowing aquifer) to the ground surface or base of the pitless unit or pitless adapter.

These requirements are designed to prevent uncontrolled flows which can erode an uncased bore hole, making it difficult and expensive to control.

These standards apply to wells and borings within a flowing well or boring special construction area, and also to any well or boring, regardless of location, which when completed, will have an artesian flow rate of 70 gallons per minute or greater, or artesian pressure of 10 pounds per square inch (psi) or greater at the land surface. Contractors should anticipate flowing conditions, and design, bid, and construct the well or boring accordingly.

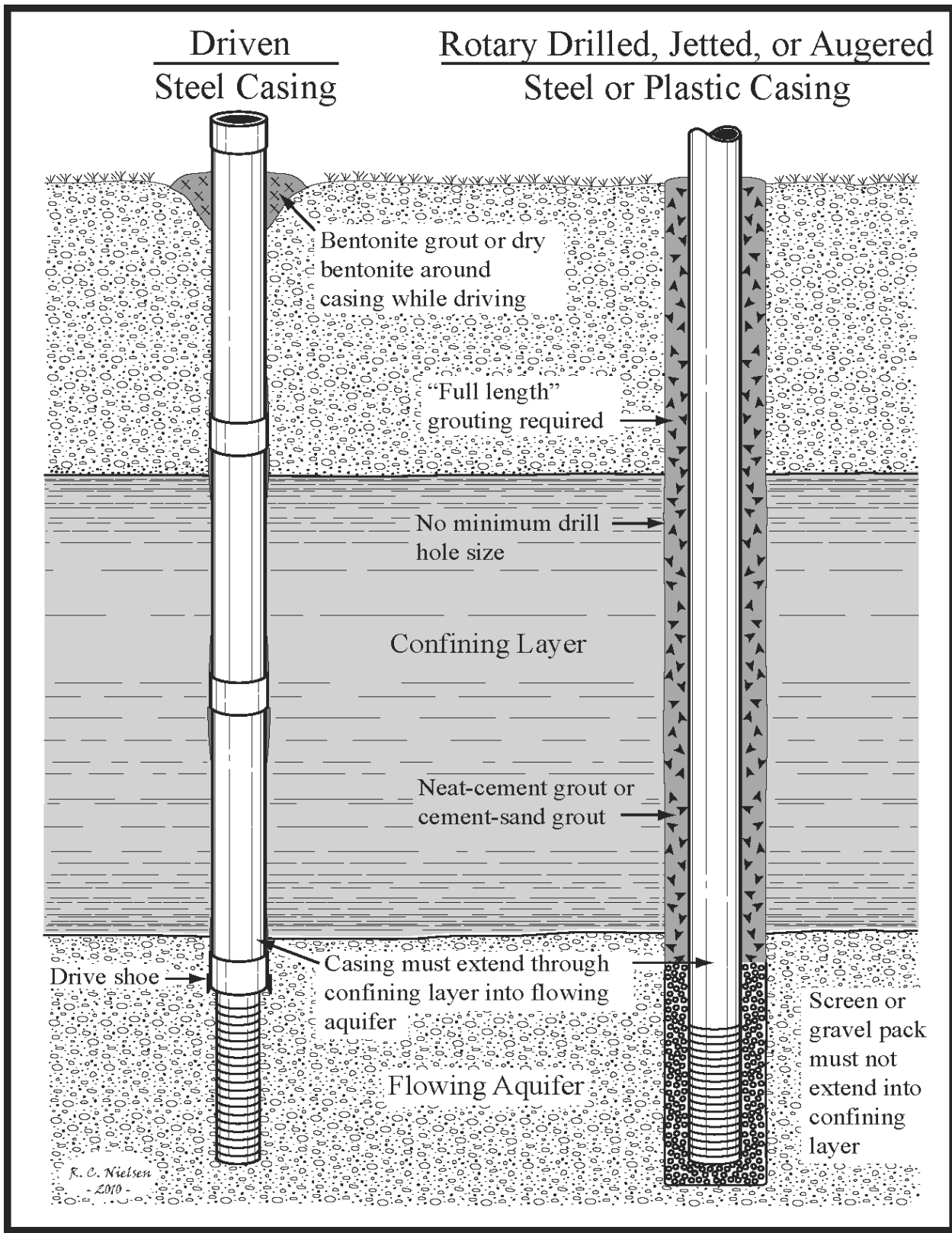

Figure 19. Flowing Wells and Borings; Less Than 70 g.p.m. and Less Than 10 p.s.i.

## Rotary Drilled, Jetted, or Augered Steel Outer Casing with Plastic or Steel Inner Casing

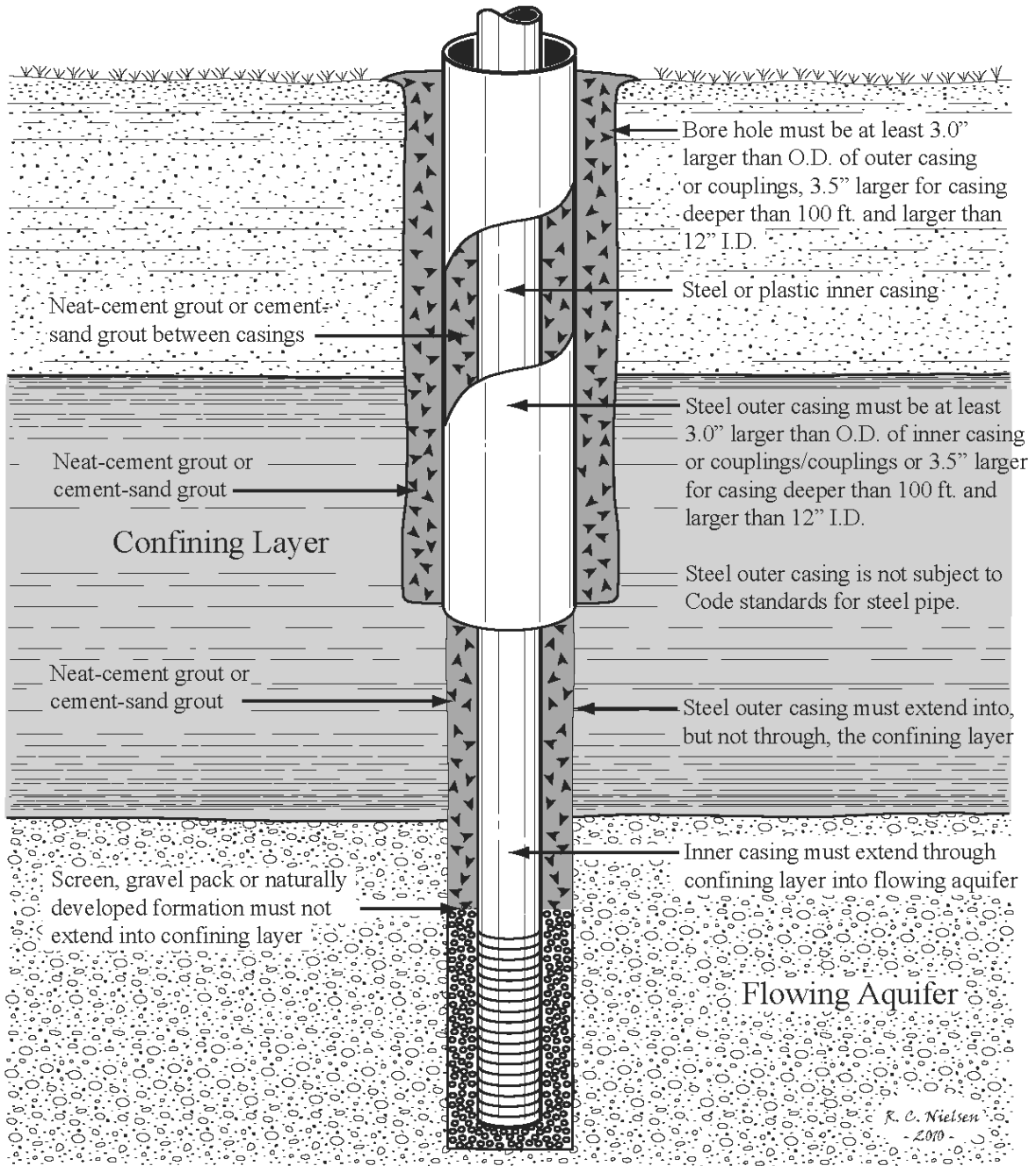

Figure 20. Flowing Wells and Borings; More Than 70 g.p.m. or More Than 10 p.s.i.

*Subp. 3. [Repealed, 33 SR 211]*

*Subp. 4. **Flow control.** A flowing well or boring must be provided with flow control capable of stopping all flow, consisting of a valved pipe connection, watertight pump connection, specially designed pitless unit, or a receiving tank set at an altitude corresponding to that of the artesian head.*

This rule does not require flow from a well or boring to be permanently stopped; only that the well is constructed so flow **can** be completely stopped. The MDH recommends using an approved flowing well pitless unit where possible, which stops the flow, because it provides the best protection from freezing and conserves groundwater. Contractors are cautioned that flowing wells may exert considerable pressure. Removal of the spiders or fittings from a flowing well pitless spool may cause the spool to rapidly eject from the casing and potentially cause injury.

Allowing a well to flow wastes groundwater resources, reduces artesian pressures, may accelerate casing corrosion and/or mineral encrustation, may lead to land subsidence or erosion problems, and may adversely affect nearby wells. Minnesota Statutes, section 103I.103 allows the DNR to order a person to prevent the waste of groundwater. The DNR has authority in matters relating to groundwater use and may require an appropriation permit.

The use of **mineral oil, antifreeze, or other chemicals** in a well or boring to control flow and prevent freezing is **not allowed**. Contractors have reported success in some situations by pressurizing the casing with air to depress the water level and prevent flow. However, this practice is not recommended since it is difficult to maintain the air pressure long term, and the casing seal, cover or cap may be forcefully detached from the casing causing damage or injury.

Special flowing spool pitless units will often provide the best solution to both controlling flows and providing freeze protection. Some manufacturers report that units are capable of withstanding pressures up to 50 psi. To prevent injury or damage, it is advisable to label or otherwise place a warning identification on a casing under pressure. Drawdown seals are not recommended for heads over 5 psi or 11.5 feet of water (for each 1 psi, water will rise approximately 2.3 feet). Clamp-on pitless adapters, used for buried discharge lines, are generally not recommended, since the gaskets will not always remain under positive pressure. "Snifter" valves are prone to failure due to iron or calcium deposits. "Overflow" lines are not recommended. If an overflow must be installed, it is recommended that the flow be reduced as much as possible. Reports indicate that as little as 1 g.p.m will prevent freezing.

*Subp. 5. **Overflow discharge.** A water discharge from a flowing well or boring that disposes of water to the surface, a surface water body, sewer, or subsurface must:*

- A. be protected with an air gap according to part 4715.2010;*
- B. have a valve or other mechanism as required in subpart 4 capable of stopping all flow; and*



*C. have the outlet screened with a noncorrosive mesh screen having openings of 1/16 inch or less.*

The purpose of the air gap is to prevent back-siphoning of surface water into the well which may occur if the discharge pipe is submerged and the water level drops in the well, as is likely with low volume flows when the pump turns on. Minnesota Rules, Chapter 4715 (Minnesota Plumbing Code) requires an air gap based on the diameter of the discharge pipe. The air gap calculations described in Minnesota Rules, part 4715.2010 are intended for indoor plumbing applications and may not provide adequate protection for discharge to an open body of water. The MDH recommends that a discharge pipe be elevated 1 foot above the regional flood level.

If the discharge pipe is fitted with a valve for stopping the flow, the valve must remain accessible. It may not be buried unless it can be operated from the surface. If the discharge pipe is fitted with a valve, it is recommended that the well or boring be designed so that if the valve is closed, water will not freeze inside the casing, or flow out of the cap, vent, electrical conduit or another opening. This will typically require the use of a sanitary seal without a casing vent.

*Subp. 6. Temporary wells and borings. Temporary wells and borings that flow, and are sealed within 30 days of the time construction begins, are not required to be constructed in accordance with this part, but must be constructed to prevent erosion of the aquifer, drill hole, or surrounding property, and must be sealed to stop all flow with neat-cement grout or cement-sand grout according to part 4725.3850.*

The MDH advises contractors that a “temporary” flowing well or boring may quickly become difficult and expensive to seal, or may cause erosion or subsidence problems, if precautions such as installation of an outer casing and/or cement grout are not taken at the time of construction

For information about sealing flowing wells and borings, including the requirement to use neat-cement grout or cement-sand grout see Minnesota Rules, part 4725.3850, subpart 7.

*STAT AUTH: MS s 103I.101; 103I.111; 103I.205; 103I.221; 103I.301; 103I.401; 103I.451; 103I.501; 103I.525; 103I.531; 103I.535; 103I.541; 103I.621; 144.05; 144.12; 144.383; 157.04; 157.08; 157.09; 157.13*

*HIST: 17 SR 2773; 33 SR 211*

**4725.3500 [Repealed, 17 SR 2773]**

**FLOWING WELL AND BORING SPECIAL CONSTRUCTION AREA**  
**KABEKONA AND BENEDICT LAKES**  
**HUBBARD COUNTY**

**NOTIFICATION OF SPECIAL FLOWING WELL AND BORING  
CONSTRUCTION REQUIREMENTS**

The MDH is issuing a FLOWING WELL AND BORING SPECIAL CONSTRUCTION AREA for portions of Lakeport and Steamboat River Townships. The area is located in east-central Hubbard County, Minnesota.

The MDH has initiated special construction restrictions due to considerable flowing well problems which have been encountered in this area. High capacity flowing wells are common. Contractors have experienced problems with uncontrolled flows which have resulted in erosion of land, and damage to buildings and property.

**Wells constructed within the boundaries of this area must follow the special construction requirements.**

**BOUNDARIES OF THE SPECIAL CONSTRUCTION AREA**

The special construction area includes properties on the southeast shore of Kabekona Lake and on the southwest shore of Benedict Lake which are within 25 feet of lake level, or generally below an elevation of 1320 feet as indicated on the accompanying map. The standard lake levels recognized by the U.S. Corps of Engineers are 1296 above sea level for Kabekona Lake and 1295 feet for Benedict Lake. The map indicates the general area affected. A more detailed map is available from the Bemidji office of the MDH.

**REQUIREMENTS FOR WELL AND BORING CONSTRUCTION WITHIN THE FLOWING WELL AND BORING AREA**

Within the area, a well or boring must be constructed by:

- A. Drilling a bore hole a minimum of 3.0 inches larger than the outside diameter of the casing or couplings, whichever is larger, into the confining layer overlying the flowing aquifer. Casings larger than 12 inches and deeper than 100 feet must be installed in a 3.5 inch larger bore hole. The confining layer in these areas generally extends from the surface to a depth of approximately 45 feet. Occasional sand formations up to several feet thick with possible low flows may be encountered in the upper 20 feet of the confining layer. The bore hole must not penetrate the entire thickness of the confining layer;
- B. Installing steel casing into the confining layer;
- C. Pumping neat-cement grout or cement-sand grout into the annular space surrounding the casing from the bottom of the casing to the established ground surface;
- D. Drilling through the confining layer into the aquifer;
- E. Installing an inner casing into the aquifer in accordance with Minnesota Rules, part 4725.2250, subpart 8; and
- F. Grouting the annular space surrounding the inner casing with neat-cement grout or cement-sand grout. Grouting must be in accordance with Minnesota Rules, part 4725. 3050.

As a caution, be aware that flowing conditions may be encountered outside the designated area. If flow rates outside the area exceed 70 g.p.m or have pressures exceeding 10 psi at the land surface, well and boring construction must be in accordance with the requirements listed for the Kabekona/Benedict special construction area. If flows encountered outside the special construction area are less than 70 g.p.m or 10 psi, the well or boring must be grouted with neat-cement grout or cement-sand grout if rotary drilled, or constructed with driven plain-end or threaded and coupled steel casing.

If you have any questions regarding this special flowing well and boring construction area, contact Kelly Jorgensen at 218-308-2112, or Mark Malmanger at 218-308-2118.

Special Well and Boring Construction Area  
(SWBCA) for Flowing Wells and Borings  
Kabekona Lake and Benedict Lake

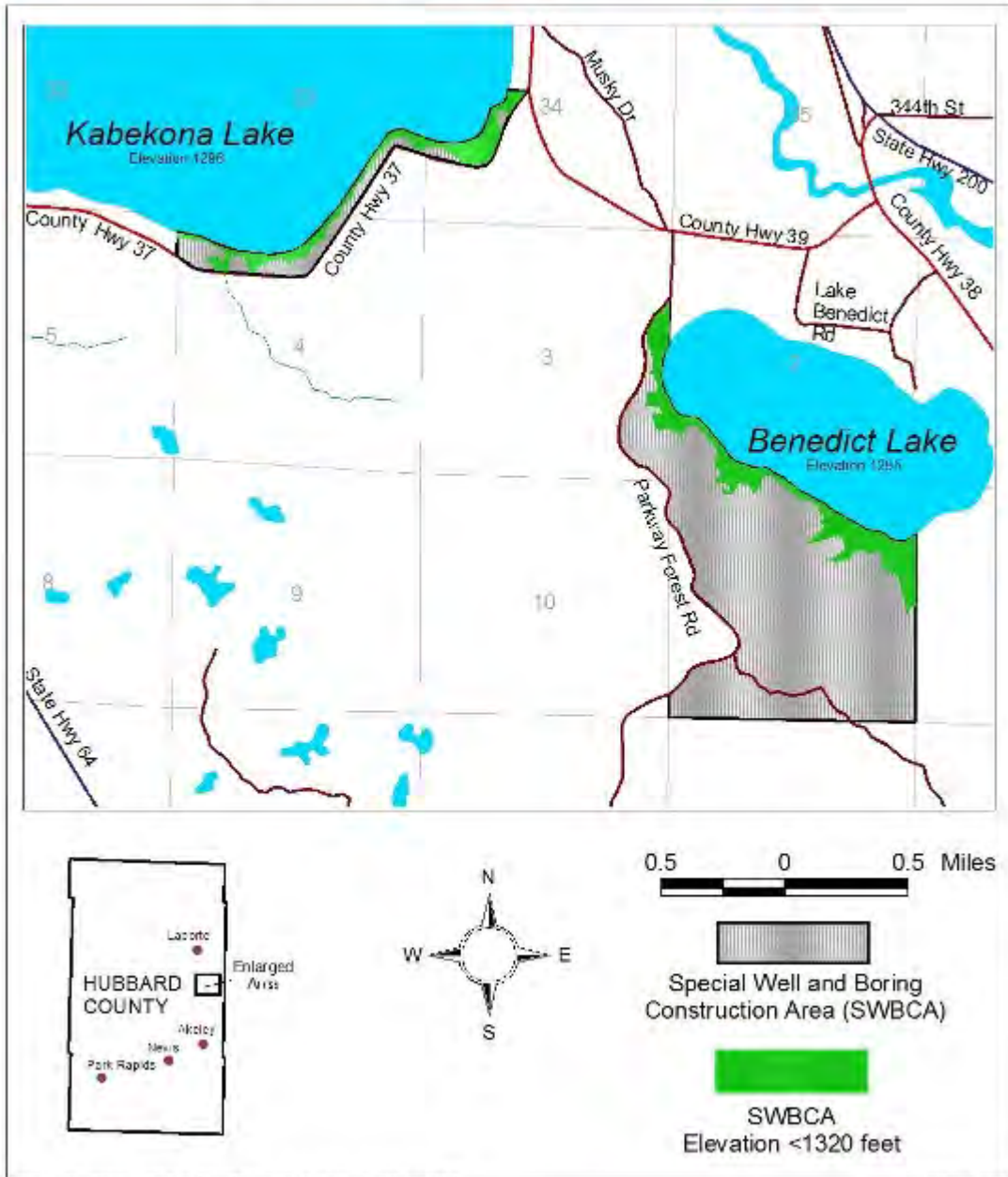

Minnesota Department of Health - Well Management Section

March 2009

\\WELL\AD\VI\kabekona-benedict\kabekona-benedict-map.jpg

## **4725.3550 WELL LABEL.**

***Subpart 1. Label required.*** A person who has constructed a well must attach a well identification label provided by the commissioner to the well before placing the well into service unless the well is sealed within 90 days of construction.

All wells, including potable water-supply, nonpotable water-supply, monitoring, and dewatering, which are not sealed within 90 days of construction must be labeled. The label is not required if the well is sealed within 90 days of construction. Borings, including vertical heat exchangers, environmental bore holes, and elevator borings, are not required to be labeled; however, it is recommended that permanent borings, such as piezometers, be marked with the Minnesota unique well number for identification purposes.

The licensed contractor who constructs a well (including water supply, monitoring, and dewatering) must attach a well identification label to it before placing it into service. Well labels are provided by the MDH Well Management Section with the Well and Boring Record form, and consist of a 2-inch by 3-1/2-inch rectangular aluminum tag with the Minnesota unique well number stamped on its face.

***Subp. 2. Attachment.*** The well identification label must be attached to the well casing in a visible location using a stainless steel clamp, band, or strap. Alternatively, the label may be attached to a concrete pump base or pedestal, or at-grade well vault using screws or fasteners.

The well label must be attached to the outside of the well casing in a visible location above the finished grade, with a stainless steel clamp, band, or strap. Wire, twist ties, plastic bands, or plastic fasteners are not acceptable. Stainless-steel "hose clamps" are recommended. The label for at-grade wells completed in a vault must be attached to the well casing with a stainless steel clamp, band, or strap; or to the inner wall of the vault with screws or rivets. The label must not be fastened to the vault cover. For municipal wells, or other wells with a pump sitting on a concrete pump pedestal, the label may be attached to the concrete pump base using screws or fasteners suitable for concrete.

***Subp. 3. Maintenance.*** The property owner must maintain the well identification label in a readable condition.

The property owner (unless a written agreement exists identifying a different well owner) is responsible for replacing lost or damaged well labels. Replacement labels are available from the MDH Well Management Section.

***Subp. 4. Removal; reattachment.*** The well identification label must not be removed except to work on the well. On completing work, the label must be reattached.

STAT AUTH: MS s 103I.101; 103I.111; 103I.205; 103I.221; 103I.301; 103I.401; 103I.451; 103I.501; 103I.525; 103I.531; 103I.535; 103I.541; 103I.621; 144.05; 144.12; 144.383; 157.04; 157.08; 157.09; 157.13

HIST: 17 SR 2773; 33 SR 211

**4725.3600 [Repealed, 17 SR 2773]**

## **4725.3650 REQUIREMENTS FOR DESIGNATED SPECIAL WELL AND BORING CONSTRUCTION AREAS.**

*Subpart 1. **Plan review.** When the commissioner designates an area where contamination is detected as a special well and boring construction area, a well or boring must not be constructed, repaired, or sealed until the commissioner has reviewed and approved a proposed plan submitted by the installer. Sealing, repair, construction, and location must be in accordance with the approved plans. In addition to the information on the permit or notification, the plan must include the:*

- A. depth;*
- B. location;*
- C. casing type, diameter, and depth;*
- D. method of construction, including grout materials and grout method;*
- E. pumping rate; and*
- F. use.*

*Subp. 2. **Water quality monitoring.** The commissioner may require water quality monitoring by the property owner, well or boring owner, or other person in a designated special construction area if the commissioner finds monitoring is needed to determine the degree of contamination.*

*Subp. 3. **Additional requirements.** The commissioner may specify well and boring location and construction requirements more stringent than those specified in this chapter if the commissioner determines, based on an assessment of hydrogeologic conditions and contaminant characteristics, that additional requirements are needed to protect the public health or prevent degradation of the groundwater.*

*Subp. 4. **Water treatment.** The commissioner shall require the owner of a newly constructed contaminated well in a special well and boring construction area to install, use, and monitor an effective water treatment device if the commissioner determines that such a device is reasonably necessary to assure a safe drinking water supply or monitor the degree of contamination.*

Special Well and Boring Construction Areas (SWBCA) were originally referred to as “Well Advisory Areas.” The name changed to “Special Well Construction Areas” (SWCA) when Minnesota Rules, Chapter 4725 was revised in 1993, and to “Special Well and Boring Construction Areas” (SWBCA) when Minnesota Rules, Chapter 4725 was revised in 2008.

A SWBCA is a defined area in Minnesota where significant groundwater contamination is present in one or more aquifers and has, or may, pose risks to public health and/or the environment. The purpose of designating a SWBCA are to ensure that new potable water-supply wells provide a safe source of supply, that unused wells and borings are properly sealed, and that construction and repair do not spread the contamination or interfere with remedial measures.

SWBCAs are established by the MDH Well Management Section. The MDH publishes and issues a notice for each SWBCA. The notice includes a description of the SWBCA boundaries; a map depicting the boundaries; information about the contaminant(s); its source; aquifers affected; site investigation and remediation; site hydrogeology; public health risks; and special construction, repair, sealing, monitoring, and treatment requirements for wells and borings within the boundaries. The requirements within a SWBCA supersede requirements or exemptions in the rules. The requirements are dependant on the geology, contamination type and extent, and remediation at each site. Therefore, the requirements for one SWBCA may be different from other SWBCAs. The requirements within a SWBCA may vary within the SWBCA, and requirements may change through time as the contamination and site conditions change.

A SWBCA notice alerts the public, including property owners, contractors, and local officials to the presence of groundwater contamination in a particular area and the need to place special requirements on well and boring construction, repair and sealing activities within the area. Contractors, government officials, and the public are notified of the implementation of a new SWBCA by a press release, public meeting, direct mailing, notice in the Minnesota Well Management News newsletter, direct mailings and by a notice on the MDH Web site at: [www.health.state.mn.us/divs/eh/wells](http://www.health.state.mn.us/divs/eh/wells).

When contractors are hired to construct, repair, or seal wells or borings in a designated special well and boring construction area, the contractor and the owner must submit a proposed written plan to the MDH district hydrologist or well inspector, or the delegated authority; and the plan must be approved in writing before any work may begin. In cases of new water-supply well construction where water samples are required to be collected and tested, analytical results must be sent to the MDH or the delegated authority and be reviewed before a water-supply well may be placed into service.

## **SPECIAL WELL AND BORING CONSTRUCTION AREAS** **September, 2010**

- **Baytown Township/West Lakeland Township/Bayport/Lake Elmo** – Washington County.
- **CMC Heartland Lite Yard Site** – Minneapolis, Hennepin County.
- **East Bethel Sanitary Landfill** – East Bethel, Anoka County.
- **Eckles Township** – Beltrami County.
- **Inver Grove Heights (Pine Bend Area)** – Dakota County.
- **Lake Elmo/Oakdale** – Washington County.
- **Lakeland/Lakeland Shores/Afton/West Lakeland Township** – Washington County.
- **Lehillier** – Blue Earth County.
- **Long Prairie** – Todd County.
- **Northern Township (Kummer Landfill)** – Beltrami County.
- **Perham** – Otter Tail County.
- **St. Paul Park & Newport** – Washington County.
- **Spring Grove Township and Spring Grove** – Houston County.
- **Twin Cities Army Ammunition Plant (TCAAP)** – Ramsey, Hennepin, and Anoka Counties.

Additional details and maps of each SWBCA are included in the appendix.

*STAT AUTH: MS s 103I.101; 103I.111; 103I.205; 103I.221; 103I.301; 103I.401; 103I.451; 103I.501; 103I.525; 103I.531; 103I.535; 103I.541; 103I.621; 144.05; 144.12; 144.383; 157.04; 157.08; 157.09; 157.13*

*HIST: 17 SR 2773; 33 SR 211*

**4725.3700** *[Repealed, 17 SR 2773]*



**End  
of  
Special Construction Areas Section**

## **4725.3725 CHEMICAL TREATMENT AND REHABILITATION.**

***Subp. 1. Treatment chemicals.*** Chemicals placed in a well or boring to increase the yield, remove or treat contaminants or objectionable tastes or odors, or rehabilitate the well or boring must meet the requirements of ANSI/NSF standard 60-2003e as determined by a person accredited by the ANSI under ANSI Standard Z34.1-1993. Sodium or calcium hypochlorite may be used if registered by the United States Environmental Protection Agency according to the Federal Insecticide, Fungicide, and Rodenticide Act (FIFRA) section 3(c)(7)(A), as an antimicrobial pesticide for use in potable water. Treatment chemicals must be neutralized or removed from the well, boring, and any connected piping systems prior to use of the well or boring. This part does not apply to chlorine or other treatment chemicals added to a water distribution system, or to a drilling additive used according to part 4725.2950.

This rule applies to chemicals introduced into a well or boring for one-time or short-term treatment such as shock disinfection or screen rehabilitation, or for continuous treatment of the well such as in-well chlorinators. Continuous in-well treatment is not allowed on a public well without plan approval. Continuous in-well water treatment is not recommended on private wells. This does not apply to water treatment chemicals added after (downstream) of the well.

Sodium or calcium hypochlorite, often referred to as “chlorine” is the most common well or boring treatment chemical. Calcium hypochlorite is commonly sold in a powder, granular, or pellet form. Sodium hypochlorite is commonly sold as a liquid, either as “bleach,” or as liquid sodium hypochlorite. Chlorine products are primarily used to eliminate organisms such as coliform bacteria, or “mineral” bacteria such as iron or sulfur bacteria. Additional information about chlorine may be found in Minnesota Rules, part 4725.5550.

Other well treatment chemicals such as oxidizers, surfactants, polyphosphates, or acids are sometimes used.

Any treatment chemical introduced into a well or boring, must meet the requirements of ANSI/NSF Standard 60 except that chlorine products may instead be registered as an antimicrobial pesticide by the U.S. EPA under FIFRA. A list of chlorine products registered under FIFRA is included in the appendix.

Persons introducing treatment chemicals into wells or borings must take precautions to minimize effects on other wells nearby.

The licensed or registered contractor is responsible to assure that all treatment chemicals are neutralized or removed from a well before placing it in service. Test meters or test strips can be used to determine the degree of removal or neutralization of treatment chemicals. Some of these chemicals are dangerous to workers and users of the water supply, and may cause damage if used or disposed of improperly.

### ***Subp. 2. Treatment with an acid.***

***A.*** Before treating a well or boring with an acid, all confined spaces enclosing the well or boring must be blown out with fresh air before entry and a supply of fresh air must be provided during occupancy. When there is a question of adequate fresh air supply, a self-contained breathing apparatus must be worn.

*B. The pH (hydrogen ion concentration) of the water must be measured prior to treatment.*

*C. The well or boring must not be placed back into service until the pH is within one pH unit of the pre-treatment value.*

Acid poses safety risks from spills which can cause serious burns to workers and damage to property. Fumes can cause lung damage and may result in low oxygen atmospheres, especially in confined spaces. Never mix acid and chlorine.

pH is a measure of acidity or alkalinity. A pH of 7 is neutral, with lower numbers being acidic, and higher numbers being alkaline. Most Minnesota groundwater is slightly above 7 (alkaline). pH can be measured by relatively inexpensive test strips or portable meters.

*STAT AUTH: MS s 103I.101; 103I.111; 103I.205; 103I.221; 103I.301; 103I.401; 103I.451; 103I.501; 103I.525; 103I.531; 103I.535; 103I.541; 103I.621; HIST: 33 SR 211*

#### **4725.3750 REPAIR, CORRECTION, OR SEALING OF WELLS AND BORINGS.**

*Subpart 1. Repair, correction, or sealing required. The property owner must:*

*A. have a defective part of a well or boring repaired, including a broken, punctured, or otherwise defective or unserviceable casing, screen, fixture, seal, connection, cover or cap;*

*B. eliminate injection or disposal of wastes, surface drainage, or flood water, directly entering a well or boring; and*

*C. disconnect a cross-connection between a well or boring and a public water system unless approved by the public water supplier and protected with an air gap or backflow prevention device in accordance with part 4715.2020 to 4715.2170.*

*A well or boring not repaired or corrected must be permanently sealed.*

The property owner is responsible for maintenance, repair, and sealing of a well or boring, unless the well owner is a different person documented as required in Minnesota Statutes, section 103I.205, subdivision 8; or another person constructed, repaired, sealed, or otherwise made the well or boring in violation of the law or rules.

This rule does not require replacement of a well or boring component on a “precode” well or boring if the component is competent and not broken or defective. However, the MDH recommends that wells and borings be brought up to rule standards when possible. A “**defective part**” means a part of the well or boring that is broken, cracked, corroded, or leaking. Some examples of defective parts include, but are not limited to a broken cap, a missing plug in a sanitary seal, a cracked casing, a hole in the casing, a broken conduit for electrical wire, or a leaking pitless unit.

A licensed or registered contractor and the certified representative are responsible to identify and report defective or broken components to the owner and recommend repair. If the contractor does not make the necessary repairs, the contractor should report the defects to the MDH Well Management Section or local

delegated well program. If the owner fails or refuses to have a defective part repaired, the MDH Well Management Section or delegated well program may order that the correction be made or may require the well or boring to be permanently sealed.

***Subp. 2. Materials. Materials used in maintenance, replacement, or repair must meet the requirements of this chapter for new installation.***

All casing, screens, pitless units and pitless adapters, piping, caps, vents, buried pressure tanks, and other materials that are added to the well or boring must meet the requirements of these rules.

***Subp. 3. Casing removal. When all casing is removed from a well or boring, the installation of new casing or the reinstallation of casing is considered new construction and must meet all the requirements of this chapter for new construction, including termination of the casing at least 12 inches above the established ground surface, and compliance with the applicable isolation distance requirements.***

**When all casing is removed** from a well or boring, and is either replaced with new well casing or the existing well casing is reinstalled, the well or boring is considered to be new and must meet all requirements of current statute and rule (be brought up to current code). This most commonly applies to drive-point wells where the casing is removed in order to replace a well screen.

Example: A person has a well that was constructed prior to July 15, 1974, that is 10 feet from a buried sewer pipe. The well has a 1-1/4-inch diameter casing with a screen that is screwed onto the bottom of the casing. If the screen fails and the well casing must be pulled out to replace the screen, then the casing may not be reinstalled in the same location since it would be too close to a buried sewer pipe. To gain compliance with the rules, the original well must be permanently sealed and a new well constructed with new casing and the appropriate separation distance from the sewer, or the sewer pipe must be moved to meet the required setback distance from the well.

A notification or permit is required when casing is added or removed below the frost line. A notification or permit is not required to replace a cap, pump, drop pipe, telescoped screen, buried pressure tank, or pitless unit or adapter.

Casing that has been in the ground for more than 120 days or that does not meet the requirements of new casing must not be reused as well or boring casing (Minnesota Rules, part 4725.2250, subpart 3).

***Subp. 4. [Repealed, 33 SR 211]***

***Subp. 5. Repair of noncomplying well or boring. A noncomplying well or boring constructed prior to July 15, 1974 may be repaired as long as the repair meets the requirements of these rules.***

## **REPAIR OF PRECODE (1974) WELLS OR BORINGS**

A commonly asked question is, “**Does a precode (pre-July 15, 1974) well or boring have to be brought up to code when repaired?**” In general, the rules do not require a precode well or boring to be upgraded to meet the requirements of the existing code; however, it is recommended. The following general scenarios may result in the MDH requiring that a well or boring be repaired or modified to meet existing requirements or be permanently sealed:

- Under the authority of Minnesota Statutes, section 103I.231, the commissioner of health can **order repair or permanent sealing of** a well or boring if the well or boring is contaminated, if the well or boring may contribute to the spread of contamination, or if the well or boring is a threat to groundwater or public health or safety.
- Any **repair** of a precode well or boring must, in and of itself, **meet the requirements of current statute and rule**. In other words, if a “precode” well has a leaking unprotected, buried suction pipe, the suction pipe may not be replaced with another unprotected, buried suction pipe. It must be replaced with concentric piping, a suction pipe fully exposed above the established ground surface, or the pump may be replaced with a positive pressure pump like a submersible pump. Repairs including installation of a new well screen, submersible pump, or (legal) pitless unit or adapter may be performed on an old, noncomplying well. However, if the well is contaminated, or may spread contamination due to holes in the casing or an ungrouted casing or annular space, the MDH may order that the defect be repaired or that the well or boring be permanently sealed. Work cannot be done which violates the rules, such as reburying a well or boring. Removal and reinstallation of casing or installation of liner casing in a water-supply well that does not meet setback distances to contamination sources is prohibited.
- **Local governments** may require that on-site septic systems meet the local or state septic code at the time of property transfer. Local governments cannot legally require a well to be brought up to code unless the commissioner of health has delegated the well program to the local government (*See appendix for a list of local governments with delegated well programs.*). Local governments can require adherence to the septic code or zoning laws that include isolation distance requirements. Minnesota Statutes, Chapter 103I also prohibits placement of a contamination source closer to an existing well than the isolation distances in the rules. In some cases it may be necessary to drill a new well (often to replace an old nonconforming drive-point well) in order to replace a failing septic system and meet well and septic isolation distances.
- **Lending institutions** may require a well to meet minimum standards, such as Federal Housing Authority (FHA), Housing and Urban Development (HUD), or state codes before a mortgage will be given.

## **REPAIR OF OTHER NONCOMPLYING WELLS OR BORINGS**

Another commonly asked question is, “Can I work on a well or boring which does not meet the standards of the rules?”

- If a well or boring was constructed at a time when the rules were in effect, and the construction did not meet the standards in effect at the time, the well or boring is out of compliance. The noncompliance should be reported to the MDH Well Management Section. The MDH may pursue legal remedies to have the noncompliance corrected. If repairs are made, they may create new violations, complicate the remedies, and may involve the contractor in monetary disputes with the owner and enforcement actions by the MDH. For instance, if a water-supply well was constructed after July 15, 1974, too close to a septic tank, and a licensed well contracting firm repairs the well by installing a liner casing, the contractor could be cited for well construction too close to a septic tank.

- It is permissible to clean out or drill an existing well or boring deeper within the same aquifer. A notification or permit is required if well casing is added or removed below the frost line.

If a well or boring has a cap that does not meet today's requirements, the MDH recommends that at the time of repair, the **cap** (even though it may not be broken) be replaced with a new approved cap as specified in Minnesota Rules, part 4725.4950. If the cap is broken or otherwise defective, it must be replaced with a new, watertight vermin-proof, approved cap.

If a liner (inner) casing is added to a well in the flood plain, or a pitless unit is installed on a well in the flood plain, the wellhead must be completed to meet flood protection standards.

***Subp. 6. Casing extension on buried well or boring. A well or environmental bore hole with the upper termination of the casing buried below the established ground surface must have the casing extended 12 inches above the ground surface when the well or boring is uncovered.***

When a well (water supply, monitoring, or dewatering) or environmental bore hole, with a **buried seal** (top of casing covered with dirt) is dug up to be repaired, the casing must be extended at least 12 inches above-grade. If repair is done only to a jet pump in a basement, and the well is not excavated, it is not required to extend the casing, but it is recommended. The materials used in repair must meet the standards of the rules. Defective casing, seals, and fittings must be repaired.

**Casing extension** must be done in accordance with the rules. The casing must meet the standards in these rules for new construction. The connection between the old casing and the new must be threaded, welded, solvent-welded, or in some circumstances a bolted sleeve-type coupling ("Dresser" coupling) meeting ANSI/AWWA Standard C219-01 is allowed.

It is not required to extend the casing of a pre-1974 **well in a pit** above-grade. However, it is strongly recommended. When extended, the walls and floor of the pit should be broken up or removed. The pit must be filled with clean soil.

***STAT AUTH: MS s 103I.101; 103I.111; 103I.205; 103I.221; 103I.301; 103I.401; 103I.451; 103I.501; 103I.525; 103I.531; 103I.535; 103I.541; 103I.621; 144.05; 144.12; 144.383; 157.04; 157.08; 157.09; 157.13***  
***HIST: 17 SR 2773; 33 SR 211***

***4725.3800 [Repealed, 17 SR 2773]***

## **4725.3850 SEALING WELL OR BORING.**

*Subpart 1. Sealing required. A well or boring, including an unsuccessful well or boring, regardless of when constructed, that is not in use, and that has not been issued a maintenance permit, or that is required to be sealed according to Minnesota Statutes, section 103I.301, must be sealed in accordance with this part by a contractor licensed or registered according to this chapter.*

The term “**sealing**” or in the case of wells – “well sealing,” refers to the process of permanently decommissioning and taking a well or boring out of service and filling the well or boring with grout. This involves removing the pump, pumping equipment, and obstructions in the well or boring; cleaning the well or boring out to its original depth; removing, perforating or grouting liner casings when necessary; and filling the well or boring with an approved grout. The term “sealing” replaces the term “abandoned” or “abandoning,” which is no longer used in the rules. In Minnesota, permanent sealing of regulated wells and borings must be done by a licensed or registered well and boring contractor as prescribed by the rules. The sealing rules apply to wells and borings that were once in service and are no longer in use, unsuccessful wells or borings, test holes, and temporary wells and borings which are no longer needed.

At all times, a well or boring must be in one of three conditions: (1) in use, (2) under a maintenance permit, or (3) properly sealed. A boring must either be in use or properly sealed. There are no maintenance permits for borings. Wells or borings that were “improperly” sealed in the past, that is, do not meet the sealing standards in the rules, are not properly sealed.

### **WHO MAY SEAL A WELL OR BORING**

Sealing must be done by a well or boring contractor **licensed or registered** by the MDH. If a contractor is licensed or registered to construct a type of well or boring, the contractor may seal that type of well or boring. A property owner or well owner **may not** seal any type of well or boring, including a drive-point well. Summaries after Minnesota Rules, part 4725.0475 and at the beginning of Minnesota Rules, part 4725.1832 detail who can seal wells and borings.

### **SEALING NOTIFICATIONS, PERMITS, AND FEES**

A well **sealing notification and well sealing fee** must be filed with the St. Paul office of the MDH Well Management Section, during normal business hours, prior to sealing any water-supply well, monitoring well, or dewatering well. This includes drive point wells, irrigation wells, temporary monitoring wells, and temporary dewatering wells. Removal of the well pump, pumping equipment, or liner casings, and perforation of well liner casings or removal of obstructions is considered sealing, and may not be done before a valid well sealing notification and fee are submitted. A notification or fee is not required for sealing a boring. If the well is located in a county or city under the jurisdiction of a delegated well program, contractors must contact the delegated well program for a well sealing permit application and fee information before beginning any sealing work. A sealing report must be filed after sealing any well **or** boring. The report must be sent to the MDH Well Management Section within 30 days of sealing, except when the well is in a delegated jurisdiction in which case the sealing report is sent to the delegated well program.

## **WHO REGULATES SEALING**

The authority to regulate the construction, repair, and sealing of wells and borings is with the **MDH**. The MDH has **delegated** portions of its authority to some local Community Health Service agencies (CHS), also known as local boards of health. The appendix contains a list of local governments with delegated well programs and the portions of the program delegated. The MDH has the authority to delegate some, or all of the following portions of the program:

- Construction, repair, and sealing of water wells;
- Construction, repair, and sealing of monitoring wells;
- Construction, repair, and sealing of dewatering wells; and
- Sealing of water wells.

All (current as of 2009) delegated well programs have received the authority for construction, repair, and sealing of water wells. The construction, repair, and sealing of monitoring and dewatering wells has only been delegated to a few delegated well programs. No delegated well programs have chosen to regulate elevator borings, and other borings may not be delegated. Community well sealing (and construction) are not delegated.

Minnesota Statutes, Chapter 103I, gives authority to local governments, whether delegated or not, to require sealing, in accordance with the rules, of wells that meet the conditions of the law. Minnesota Statutes, Chapter 103I, gives all counties the ability to abate an unsealed well as a public health nuisance, order the owner to have the well sealed, and if the well is not sealed, have the well sealed and assess the costs to the property owner. In addition, the statute allows a county, municipality, city, or town to require covering or other protection of open wells, and allows the local government to establish penalties for violations.

## **WHEN MUST A WELL OR BORING BE SEALED**

An unused well or boring must be sealed or placed into service. As an alternative, a well owner may apply for a “well maintenance permit” which allows the owner to keep an unused well until such time as the permit is cancelled, the well is sealed, or the well is placed into service. There are no maintenance permits for borings. The well owner must apply for the permit, pay the annual fee, and comply with the conditions of the permit. The MDH Well Management Section has established criteria for permit approval.

Minnesota Statutes, Chapter 103I requires a well or boring to be sealed if:

- The well or boring is contaminated or may contribute to the spread of contamination;
- The well or boring was attempted to be sealed but was not sealed according to the provisions of the law; or
- The well or boring is located, constructed, or maintained in a manner that its continued use or existence endangers groundwater quality or is a safety or health hazard.

Unsuccessful attempts at wells or borings, dry holes drilled to search for water and all other excavations that meet the statutory definition of “well” or “boring” must be sealed.



*Subp. 2. Removal of obstruction; debris. Materials, debris, and obstructions that may interfere with sealing must be removed from the well or boring. Sand, aggregate, or fill materials must be removed when sealing a well or boring except that:*

*A. sand from a blasted and bailed sandstone formation may remain in a blasted and bailed sandstone formation; and*

*B. sediment may remain in a well or boring if:*

*(1) the sediment is from the well or boring itself;*

*(2) the sediment is ten feet or less in thickness and is within ten feet of the original bottom of the well or boring;*

*(3) the sediment does not contain hazardous materials or pollutants; and*

*(4) the sediment is not within a confining layer.*

### **OBSTRUCTIONS**

All debris and obstructions that interfere with sealing must be removed from the well or boring. This includes materials and equipment related to the well or boring such as pumps, wires, drop pipes, air lines, check valves, foot valves, jet assemblies, tail pipes, pump rods, pump cylinders, leader pipes, drawdown seals, or caved formation materials; and materials dumped or disposed of in the well or boring including fill, construction debris, and other materials foreign to the well or boring. Sediment, sand, or loose rock must be removed to the original total depth of the well or boring. The objective is to remove all materials which will result in a contaminant left in the bore hole (such as a pump with a PCB capacitor), a void, incomplete sealing, or permeability's higher than the surrounding geological materials. If debris or an obstruction cannot be removed, the contractor should consult with the MDH or the delegated well program on how to proceed.

The spool or drop pipe actuator (inside the casing) of a pitless adapter or unit must be removed. The outer pitless casting or discharge body (outside the casing) is not required to be removed.

Casing that is driven or grouted in place does not have to be removed. If casing is to be removed from a collapsing formation, it must be filled with grout before removal.

### **REMOVAL OF TUBULAR CHECK VALVES AND PACKER JETS**

Tubular check valves were commonly installed in 2-inch and 3-inch diameter wells to either serve as a packer on top of a telescoping well screen, or they were set at the bottom of the casing in bedrock wells for test pumping purposes. In either case, the check valves, when left in place, prevent access to the bottom of the well for permanent sealing. Tubular check valves must be removed in order to properly seal wells. The only exception, where removal of the tubular check valve is not required, is for wells with a well construction record that indicates that the well is screened in glacial deposits with a screen less than 10 feet long and the check is on top of the screen. If a well has a tubular check valve in it, and a well record does not exist for the well, the check valve must be removed before the well is sealed.

Packer jets are fittings that are used with the operation of jet pumps in wells. The packer jet or "ejector" has leather or rubber seals that pack it off tightly to the inside surface of the well casing below the water level in the well. Packer jet ejector assemblies must always be removed from wells.

## TIPS FOR REMOVING TUBULAR CHECK VALVES AND PACKER JETS

Over time, tubular check valves and packer jets can become stuck in wells due to corrosion and encrustation. Well contractors have developed many techniques that are helpful in removing stuck check valves and packer jets. The most successful techniques include flushing the well with clean water to remove any sand, rust, or scale on top of the jet assembly or check valve; screwing into the jet or check valve with a threaded taper tap or an overshot tap, and then gently tapping the stuck jet or check valve up and down with a drive block assembly operated with a cat-head. A straight pull with a hoist or jack is generally not recommended for stuck jets or check valves because this method often results in breaking the jet assembly or check valve. Acid or other chemical treatment can be employed to assist in removing stuck jets and check valves. Drilling out broken jet assemblies or check valves should be a last resort measure.

In situations where a check valve or packer jet cannot be removed from a well, the contractor should contact the MDH Well Management Section or delegated authority for further instructions before proceeding.

## DUG WELLS FILLED WITH FIELD ROCK

Dug wells are required to be sealed in accordance with Minnesota Rules, part 4725.3850, subpart 4, item A.

If a dug well has been **filled by a person other than a licensed contractor**, a licensed well contractor or well sealing contractor must investigate the materials in the well. This may require excavation by backhoe or drilling into the filled well and determining if the well contains proper materials. In some instances, dug wells have been filled with field stones making it difficult or impossible to verify. If reliable well depth information is available or investigation indicates the probable well depth is 30 feet or less the following may be done:

- Excavate by backhoe or otherwise to a minimum depth of 15 feet. If the well contains geologic materials with permeability's equivalent to the surrounding geology, and does not contain hazardous material (garbage, oil, cans, pesticide containers, etc.), the hole may be refilled with the native materials.
- If it is determined that the dug well is deeper than 30 feet, and it is not possible to remove the debris, a variance will be considered. The MDH will review the depth, construction, geology, and the fill materials. If the MDH determines that risk to the groundwater is low, a variance will be granted to allow sealing by clearing the well or excavating to a minimum depth of 15 feet and sealing the top 15 feet with impermeable material.
- If the well contains hazardous materials, the well must be cleaned out to its original depth and properly sealed.

*Subp. 3. Casing grouting, removal, and perforation. The open annular space surrounding a casing must be grouted by:*

*A. filling the annular space with grout according to this part;*

*B. removing the casing and filling the well or boring with grout. If casing is to be removed from a collapsing formation, grout must be inserted so that the bottom of the casing remains submerged in grout; or*

*C. perforating or ripping the casing and forcing grout through the perforations. Grouting must start within 24 hours of perforating. Perforations or rips must penetrate the full thickness of the casings to be perforated or ripped. Casing to be perforated or ripped must:*

*(1) be perforated with a minimum of one-half square inch of open area in each foot of casing for casings 16 inches in diameter and smaller, and one square inch of open area in each foot of casing for casings larger than 16 inches in diameter. No perforation shall have an open area of less than one-eighth square inch;*

A round hole with 1/2 square inch of open area is equivalent to a hole slightly larger than 3/4 inches in diameter.

A round hole with 1 square inch open area is equivalent to a hole slightly larger than 1-1/8 inches in diameter.

*(2) be perforated with a single hole at least two square inches in open area in each five feet of casing; or*

A round hole with 2 square inches of open area is equivalent to a hole slightly larger than 1-5/8 inches in diameter.

*(3) be ripped a minimum of five feet for every 20 feet of casing.*

This means that a 5-foot section of casing is ripped and then the next 15 feet are not ripped. Ripping across a coupling, through a casing formation, or ripping Schedule 80 or heavier casing may be difficult.

This **does not apply in confining layers**. The entire cased interval which has an ungrouted annular space through a confining layer must be ripped (or perforated).

*Casing must be perforated or ripped through the entire length of a confining layer.*

*Casing is not required to be removed, perforated, or ripped if a single casing extends less than 20 feet into the first bedrock encountered, and the bedrock is sandstone or limestone, or the casing was driven through an unconsolidated formation, sandstone, or shale.*

Casing does not have to be removed from a properly grouted well, or a single cased driven well completed in an unconsolidated formation or sandstone.

The contractor must assess each well or boring to determine the best course of action. In general, the least costly and safest method to grout between casings if there is sufficient space is to grout with a tremie pipe or grout through an inner casing. If the inner casing is accessible, competent, and the formation noncaving, removal is usually the next best option. Perforation may be the best or only solution in some cases, but may be more expensive and risky from a safety and potential well failure standpoint.

The open hole portion of a well or boring in bedrock should generally be grouted prior to perforation. This reduces the risk of collapse. However, the amount of grout must be carefully measured. Once the open hole has been grouted, the casing should be filled with water. If perforation is successful, the water level will usually drop.

Contractors may wish to use well inspection cameras to verify successful perforation.

The casing of a drive-point well may not be “**pulled**” and the soil allowed to collapse.

### **UNCONSOLIDATED FORMATIONS**

A rotary drilled well or boring in unconsolidated materials has an open annular space unless the annulus was grouted with cement or bentonite, or was filled with cuttings. A single driven casing installed by cable tool or a drill-and-drive method in unconsolidated materials is not considered to have an open annular space.

### **BEDROCK**

A casing installed more than 10 feet into bedrock in an oversized bore hole (drilled by rotary or similar method) has an open annular space, unless it can be proven (usually through a well record or other report) that the annular space was grouted with cement. However, casing extending less than 20 feet into sandstone or limestone does not have to be perforated when sealing. A single casing driven through glacial drift into or through a sandstone formation (St. Peter, Jordan, Franconia, or Mt. Simon-Hinckley), or confining layer (Decorah, Glenwood, St. Lawrence, or Eau Claire) is not considered to have an open annular space. Casing extending into bedrock on pre-1974 wells and borings is assumed to be ungrouted unless information exists which indicates that the casing was driven or grouted.

### **MULTIPLE CASINGS, LINERS, AND TELESCOPED CASING**

Wells or borings with multiple casings, casing liners, telescoped casings, or telescoped-leader pipes have an open annular space between the casings, unless records indicate that the space was cement grouted. If the casing overlap is 10 feet or less, the remainder of the casings are grouted or driven, and the overlap is not adjacent to a confining layer, it will not be necessary to perforate or rip the overlap.

UngROUTED liner casings must be removed, grouted in place, or perforated before sealing the well. Open annular space surrounding liner casings may be grouted by pumping cement grout through a grout pipe inserted to the bottom of the annular space, or by pressure grouting through the casing until the annular space is full of grout.

One-half square inch of hole is equivalent to a round hole slightly larger than 3/4-inch in diameter. The total open area of hole(s) in each 1-foot section of casing must total 1/2-square inch. Multiple holes can be made that add up to the total. However, experts in perforation recommend that with standard cement grout, and typical grout pressures, holes should be no smaller than 3/8 inches in diameter.

The rules require that the entire length of ungrouted casing with an open annular space be perforated or ripped. In some instances, such as casing extending through the Prairie du Chien formation, the MDH Well Management Section or delegated well program may allow perforations at selected horizons in lieu of perforating the entire length of casing. Contractors must submit information detailing the casing, grouting, and geology of the well or boring and obtain approval from the MDH or delegated well program prior to using this alternate.

## **GROUTING PERFORATED WELLS OR BORINGS**

The following are comments and recommendations concerning the grouting of wells and borings which require perforation:

- Casing removal or grouting between casings is generally preferable to perforation; however, each case is unique and should be evaluated based on quality of sealing, cost, and risk.
- The open hole portion should be grouted prior to perforation.
- Minimum perforation hole size should be 3/8 inch diameter.
- The casing should be televised or pressurized with water to 20 pounds per square inch higher than the head pressure to verify that the perforations are open.
- Type 1 Portland neat-cement grout with a density of 15 pounds per gallon should be used.
- The grout should be pressurized to 50 pounds per square inch over the head pressure. The head pressure of a fluid column can be calculated by multiplying the weight per gallon of the fluid times 0.052 times the depth of the fluid in feet. This will result in the pressure in pounds per square inch at the base of the column. As an example, if the perforations are at 100 feet and the well has a 50 foot static water level, the aquifer pressure is  $8.33$  (weight of water in pounds per gallon)  $\times$   $0.052$  (pressure created by each pound of fluid in pounds per square inch per foot of depth)  $\times$   $50$  feet (depth of fluid in feet =  $100$  feet -  $50$  feet) =  $21.65$  pounds per square inch. In order to pressurize 50 pounds over the formation,  $71.65$  pounds per square inch are needed. Pressurization can be accomplished with a packer or bradenhead (well seal).
- Explosives must be used with caution, following local, state, and federal permitting, transportation, and use requirements.

## **PLATTEVILLE WELLS REQUIRING PERFORATION OR REMOVAL OF THE CASING**

The MDH Well Management Section in cooperation with the MGS has printed a map of the Twin Cities metropolitan area showing the extent of the Platteville limestone. Old wells and borings cased through the Platteville were rarely grouted and, therefore, require casing removal or perforation. This map is available from the MDH Well Management Section.

Many wells that completely penetrate the Platteville limestone may require the casings to be perforated or removed to properly seal the wells. An outer casing was often installed to the top of the Platteville and an open bore hole advanced through the Glenwood shale and into the soft St. Peter sandstone. Problems with bore hole collapse, sand pumping, corrosive water in the Platteville, or contamination may have resulted in the installation of an inner smaller-diameter casing or a leader pipe for a screen. These materials were almost never grouted into the bore hole. Because the Glenwood is a confining layer that hydrologically separates groundwater in the Platteville from the St. Peter sandstone, the ungrouted annulus allows the down-flow of water from the Platteville to the St. Peter formation. This situation poses a threat for contamination to enter the St. Peter formation. Proper sealing of these types of wells requires that the ungrouted casing(s) or leader pipes be removed or perforated to seal off the Glenwood shale confining layer.

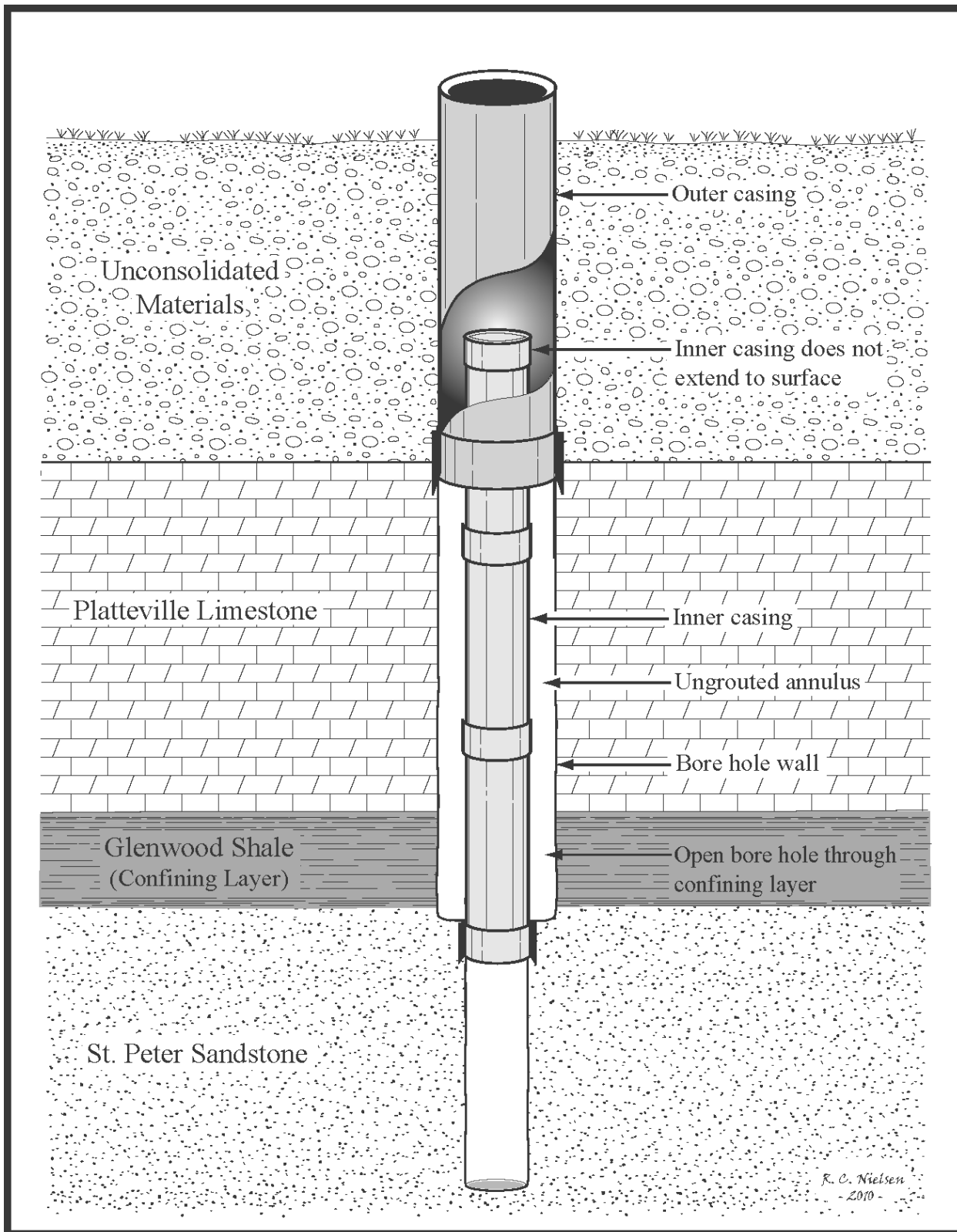

Figure 21. Typical Construction of a Well Requiring Casing Removal or Preforation Prior to Sealing

***Subp. 3a. Sealing with grout, general requirements.*** A well or boring must be sealed by filling the well or boring, including an open annular space, with grout or approved sealing materials to within two feet of the established ground surface or floor. Grout must be pumped through a tremie pipe or the casing from the original bottom of the well or boring upward. The bottom of the tremie pipe must be inserted to within ten feet of the bottom of the well or boring, and remain submerged in grout while grouting.

**Grout** materials are defined in Minnesota Rules, part 4725.0100, Minnesota Rules, part 4725.3050, and this part. Grout materials include neat-cement grout, cement-sand grout, and bentonite grout. Additional materials may be used in cases of substantial grout loss or for sealing large diameter wells and borings as described in this rule part. Generally, neat-cement grout or cement-sand grout may be used in any geological formation. Bentonite grout may be used only in unconsolidated formations.

Caution should be exercised so that grout does not flow out of the casing through the water service pipe into the home or to another inappropriate location.

All portions of the space inside a screen, casing, or open hole, and all ungrouted space between casings or between a casing and a bore hole must be grouted.

If grout settlement occurs after a well or boring has been sealed, the licensed or registered contractor who sealed the well or boring is responsible to return and refill the well or boring with approved grout to within at least 2 feet of the established ground surface or floor.

A drive-point well may not be pulled and allowed to collapse. Contractors must either seal these wells in place, or if pulled, wash a grout pipe to the original depth of the well and pump the bore hole full of approved grout.

The portion of the well or boring between a depth of 2 feet and the ground surface may be finished at the discretion of the contractor and owner. The casing may be filled with grout to the land surface or above the land surface, or the casing may be cut off 2 feet below ground and the top 2 feet filled with soil.

***Subp. 4. Approved grout for sealing well or boring in unconsolidated materials.*** The portion of a well or boring in unconsolidated material must be filled with bentonite grout, neat-cement grout, or cement-sand grout. The grout must be pumped through a tremie pipe or the casing from the bottom of the well or boring upward to within two feet of the established ground surface. Clean sand or cuttings equal to the volume of bentonite grout may be mixed with the bentonite grout, or poured into the well or boring while bentonite grout is pumped through a tremie pipe. The sand or cuttings must be poured at a rate which prevents bridging.

The **sand or cuttings may only be added to bentonite grout**, not to neat-cement or cement-sand grout. Sand or cuttings, not to exceed 15 percent by weight of bentonite may be mixed with the bentonite and water, or poured into the well or boring while pumping the bentonite and water. The sand or cuttings must be poured at the same time and rate as the bentonite grout is pumped.

**Subp. 4a. Alternative materials for sealing specified large diameter wells in unconsolidated materials.** In addition to the grout materials approved in subpart 4, a well or boring 16 inches or greater in inside diameter, less than 200 feet in depth, completed in unconsolidated materials, and containing less than 20 feet of water may be sealed by pouring at a rate sufficient to completely fill the well or boring without bridging:

A. uniformly mixed dry bentonite powder or granular bentonite and sand in a ratio of one part bentonite by volume to five parts sand;

B. clean unconsolidated materials including clay, sandy clay, and silty clay with a permeability of  $10^{-6}$  centimeters per second or less;

C. concrete; or

D. granular, pelletized, or chipped bentonite not to exceed three-fourths inch in diameter along with sufficient water to hydrate the bentonite.

**Sealing materials must have bearing strength sufficient to prevent subsidence, and support traffic or building loads.**

The 16-inch measurement refers to the inside diameter of the casing, bore hole, curbing, or tile.

The water may be pumped down to the 20-foot level in order to allow pouring the sealing material. Removing as much water as possible will result in less settlement when sealing a large diameter well.

More than any other type of well, dug wells were filled with debris. Debris ranges from soil, to rocks, to construction debris, to garbage and other wastes. Just as with any other well, it is necessary to remove the debris from dug wells. Drilled or driven wells were also sometimes constructed through dug wells. Dug wells should be inspected, and probed or excavated if needed, to determine if another (drilled) well exists inside the dug well.

Due to possible subsidence and settlement, it is recommended that large diameter wells filled with materials other than concrete be protected for some time after filling with a cover, fence, or other barrier to prevent access by animals, children, or other persons. Additional grout or sealing materials will be needed if settlement occurs.

**Subp. 5. Approved grout for sealing well or boring in bedrock.** The portion of a well or boring in bedrock must be sealed with neat-cement grout or cement-sand grout.

**Subp. 5a. Alternatives for grout loss in bedrock.**

A. The materials and methods described in item B are approved for sealing in those uncased bedrock portions of a well or boring where the following conditions exist:

(1) a cavern more than twice the diameter of the bore hole;

(2) sandstone that is blasted and bailed; or



(3) the grout level fails to rise after insertion of more than one cubic yard of grout or the quantity of grout necessary to fill ten vertical feet of hole.

B. The materials and methods in this item are approved in those portions of a well or boring where the conditions in item A exist:

(1) pouring a mixture of gravel or stone aggregate not larger than one-half inch in diameter while simultaneously pumping neat-cement grout or cement-sand grout in a ratio not to exceed five parts aggregate to one part grout;

(2) pumping a mixture of gravel or stone aggregate not larger than one-half inch in diameter and neat-cement grout or cement-sand grout in a ratio not to exceed five parts gravel to one part Portland cement; or

(3) placing alternate, equal thickness layers of cement-sand grout or neat-cement grout and gravel or stone aggregate not larger than one-half inch in diameter. Neat-cement grout or cement-sand grout must be pumped through the casing or a tremie pipe. The aggregate must be poured into the bore hole at a rate that prevents bridging. Individual layers of aggregate must not exceed ten feet in thickness except in blasted and bailed sandstone formations, where sand may be used to fill the entire portion of the blasted and bailed sandstone. Aggregate must not be emplaced in a confining layer, or inside of casing.

The aggregate is commonly referred to as “**pearock**” or “buckshot.” The aggregate must be a mineral material, most commonly washed gravel or crushed limestone. Contractors have reported that angular-crushed limestone is more effective at times for plugging voids. The mineral material may be no larger than 1/2-inch in diameter, but may be smaller if desired. Other organic or inorganic solids may not be used, such as oat or cottonseed hulls, except for natural mica (muscovite, a clay mineral) commonly sold as a lost-circulation material.

Aggregate layers must be no more than 10 feet thick, and must not be placed in a confining layer.

The entire blasted and bailed sections of sandstone formations may be filled with sand if there is a well record documenting that the well was blasted and bailed and what volume of sandstone was removed from the well; or if the well is inspected with a well inspection camera and there is video evidence of blasted and bailed caverns in sandstone formations.

**Subp. 5b. Alternative materials for sealing specified large diameter wells in bedrock.** In addition to the grout materials approved in subpart 5, a well or boring 16 inches or greater in inside diameter, less than 200 feet in depth, completed in bedrock, and containing less than 20 feet of water, may be sealed by pouring concrete at a rate sufficient to completely fill the well or boring without bridging.

This allows large-diameter wells or borings in bedrock to be filled (poured) with concrete, a material less costly than neat cement, or cement-sand grout. Concrete is defined as “a mixture of Portland cement, sand and gravel aggregate, and water in a ratio such that 1-cubic yard of concrete contains a minimum of 470 pounds (five 94 pound bags) of Portland cement, a maximum of 30 gallons of water, and sand and gravel passing a 1-inch sieve. Concrete or Redi-mix companies may refer to this as a “five-bag mix.”

*Subp. 6. [Repealed, 33 SR 211]*

***Subp. 7. Sealing flowing well or boring.*** *The discharge from a flowing well or boring must be stopped and the well or boring sealed according to this part with neat-cement grout or cement-sand grout. It is approved to use rapid setting cement, or to use hematite or barite as a weighting agent in a proportion not to exceed equal parts weighting agent and Portland cement. When a well or boring cannot be sealed as described in this part, the licensee or registrant must notify the commissioner.*

Sealing of flowing wells and borings can be problematic. Considerable expertise, planning, and the proper equipment are needed to control and seal flowing wells and borings. Cases have occurred where sealing the inside of a flowing well or boring with cement grout has stopped water flow coming from inside the well or boring; but, then water began to flow up around the outside of the casing, or at some distance from the well or boring. The contractor must then seal the annular space around the casing to stop all flowing water. In some cases this may require driving a larger diameter casing over the well or boring to contain the eroded annular space surrounding the well or boring, and to contain the water flow within the larger casing. Then grouting may be employed to seal the remainder of the well or boring and stop all flowing water.

In some circumstances it may be necessary to drill relief wells; however, our experience has generally found that they are expensive, and require multiple wells pumping large volumes of water to control the flow. Shutoff “T’s,” with or without a tremie pipe seal, have been successfully used to control discharge water and limit grout washout. Often, large quantities of grout must be quickly placed into the hole. This usually requires the use of large diameter grout pipes and large pumps. While pumps capable of large volumes may be needed, large pressures are rarely needed and may send grout to neighboring wells or “mud jack” soils. Cement additives including accelerators like chloride or gypsum, and weighting agents like barite, sand, or hematite may be useful in some circumstances.

Quick (but not careless) action is generally needed when sealing a newly drilled well or boring, a well or boring that has been damaged, or a well or boring that has corroded or other wise started to flow large volumes. A flow can rapidly get out of control and start to erode the formation, making sealing very difficult.

Problems with sealing flowing wells or borings should be reported to the MDH Well Management Section immediately.

***Subp. 8. Sealing disturbed.*** *The casing and grout seal must not be disturbed after a well or boring is sealed, except that the casing may be cut off at the base of an excavation encountering a sealed well or boring.*

Once a well or boring has been properly sealed by a licensed or registered well contractor, and the Well and Boring Sealing Record has been submitted to the MDH Well Management Section, anyone may cut the well casing off below grade, or at the base of an excavation, as long as they do not disturb the grout sealing material inside the remaining portion of the casing.

## **PREPARATION PRIOR TO SEALING**

In order to properly seal a well or boring, it is necessary to know the construction and repair history of the well or boring, and the current condition. **Prior to sealing** a well or boring, the contractor should obtain a copy of the original construction record. This may be available from the MDH Well Management Section, MGS, local government, property owner, or contractor who drilled the well. If an original record is not available, records of surrounding wells or borings can be of benefit, and should be obtained for reference. Well and Boring Records for most 1975 and later wells, and some earlier wells, are available from the MDH Well Management Section at 651-201-4600; the MGS at 612-627-4780; or from the CWI database available online from the MDH or MGS at [www.health.state.mn.us/divs/eh/cwi](http://www.health.state.mn.us/divs/eh/cwi), or on computer disk from the MGS. Maps, such as the “Platteville Well Sealing Map” and county geologic atlases can assist in determining geology. It is important to determine the **original** depth of the bore hole, the construction method, the diameter and depth of all casings, the geologic log or estimated geologic log, and the grouting materials and methods. The **present** depth, casing size and depth, and existence of obstructions must be known. Contractors are advised to obtain information about unfamiliar wells or borings by the use of appropriate tools including: a depth probe, casing magnet or induction coil, casing “dummy,” or downhole TV camera.

## **EQUIPMENT**

Well or boring sealing will often require more specialized equipment than well construction. Often, tools must be specifically built or modified for each application. Contractors are encouraged to obtain and use appropriate equipment including:

Well Locating – metal detectors, magnetometers, pipe and cable locaters;

Well Investigative Tools – water level indicators, impression blocks, depth probes, casing detectors, “casing dummies,” downhole TV cameras, geophysical equipment;

Fishing Equipment – right and left taper taps in various diameters and tapers, overshots, junk baskets, magnets, grabs, spears, latches, bailers, and drills;

Tools – air compressors, jetting tools, wash pipe, drive blocks, cat head, portable electric or hydraulic hoists, tripod assemblies, lever-action hand hoists (“pump-handle Petes”), milling bits, inside pipe cutters, various perforators, and drilling machines.

## **WATER TESTING**

Neither Minnesota Statutes, Chapter 103I nor Minnesota Rules, Chapter 4725 requires sampling and testing of water prior to sealing.

## **CONTAMINATION**

MPCA rules require reporting of petroleum or hazardous material releases. If evidence of contamination is found in a well prior to sealing, the contractor and owner must report the contamination to the state “duty officer” at 651-649-5451 or 800-422-0798. The MPCA may require testing, and remediation.

Oil from leaking vertical-line-shaft turbine pumps, submersible pumps, or other sources must be removed from the well.

## SUBMERSIBLE PUMP CONTAMINATION

Some two-wire **submersible pumps** manufactured before 1979 had starting capacitors in the motors with a dielectric fluid that contained Polychlorinated Biphenyls (PCBs). Other pumps contained nonfood grade mineral oil used to cool the motor, which contained Polyaromatic Hydrocarbons (**PAHs**). PCBs are classified as probable human carcinogens. The Maximum Contaminant Level (MCL) established by the U.S. EPA for PCBs in drinking water is 0.5 µg/l (micrograms per liter, approximately equal to parts per billion). PAHs or other fuel-like compounds have been found in the nonfood-grade mineral oil used in submersible pump motors. The Recommended Allowable Limit (RAL) for total carcinogenic PAHs is 0.03 µg/l, and total noncarcinogenic PAHs is 0.3 µg/l.

Pumps containing capacitors or nonfood-grade mineral oil should be carefully removed when sealing a well so as not to damage the pump and release the oil. Disposal of the pump should be in accordance with local and MPCA requirements. Generally, a homeowner may dispose of a pump at a county household hazardous waste facility.

The state of Wisconsin has assembled a list of submersible pump motors which may contain nonfood-grade oil and/or capacitors with PCBs. The list is not complete, but provides valuable information. The Wisconsin booklet listing pumps with nonfood-grade oil and capacitors with PCBs can be viewed at: <http://dnr.wi.gov/org/water/dwg/pubs/WaterContSubPumps.pdf>. When removing a two-wire submersible pump manufactured before 1979, it should be assumed that the motor contains nonfood-grade oil or PCBs unless proven otherwise.

Companies whose **pumps may contain nonfood-grade oil** include: Aeromotor (Century motor); Barnes (also known as Peabody Barnes Inc.); Berkley (Century motor); Century; Flint & Walling (Century motor); General Electric, Hoosier (General Electric motor); Johnson Water Systems (manufactured by Barnes); Myers, Pumptron (Century motor); Montgomery Ward (manufactured by Barnes); Rapidayton (Century motor); Reda, Red Jacket (Century motor); Tait (Century motor); Webtrol (Century motor).

Companies whose **pumps may contain a capacitor with PCBs** include: Dempster (Reda and Sta-Rite pumps), Myers (two-wire models manufactured between 1964 and 1976 in 1/3 to 1 horsepower, and some models manufactured before 1979), Fairbanks Morse (two-wire models manufactured between 1964 and 1979), Johnson Water Systems (some Peabody Barnes models), Montgomery Ward (some Peabody Barnes models), Peabody Barnes (two-wire models), Reda (two-wire models manufactured before 1979), Red Jacket (two-wire units 1/3 through 1-1/2 horsepower), Sta-Rite (two-wire models before 1979, and some three-wire motors).

## WELL DISCLOSURE

Minnesota Statutes, Chapter 103I, requires disclosure of all wells, whether in use, not in use, or sealed, on a property when there is a transfer of property ownership. The seller of the property must inform a buyer in writing, before a purchase agreement is signed, of the existence and status of all wells on the property. This “well disclosure statement” is not sent to the MDH Well Management Section, and an official MDH form is not required to be used. At the time the deed is recorded, a “well disclosure certificate” must be given to the county recorder or registrar of titles who sends the certificate to the MDH Well Management Section. This must be on an official MDH form. The well disclosure certificate is reviewed by the MDH Well Management Section for accuracy, and the MDH Well Management Section will contact the buyer, seller, or real estate parties if discrepancies are noted. If an unsealed, not in use well is disclosed, the MDH Well Management Section will contact the owner, who will be responsible to place the well in service, seal the well, or if appropriate, obtain a maintenance permit.

A seller of real property who fails to disclose the existence or status of a well that the seller knows of or has reason to know of is liable to the buyer for sealing costs and reasonable attorney fees for a period of six years after the close of the property sale. This action is the responsibility of the buyer. Some property transfer sales require binding arbitration to be taken in a specified time, typically much less than six years. Disputes that cannot be settled between the parties may proceed to conciliation or small claims court. See Minnesota Statutes, section 103I.235, subdivision 2.

### **WELLS WHICH CANNOT BE LOCATED**

The exact location of some wells is no longer known. This is especially true at abandoned building sites where the buildings have been demolished. If the well was originally buried or was buried during demolition, its location and possibly its existence can soon be forgotten. These wells usually become an issue at the time of property sale when people are trying to determine how to **disclose** the well and how much of an effort must be made to find it.

The first thing to investigate is whether there really is a well on the property. Sometimes people will disclose not in use wells because they assume there must have been a well on the property, or someone tells them that they think there might have been a well. In cases where there is no knowledge of a well, no evidence of there being a well, and information supports that there was no well such as the date of buildings is after the property was served by public water, the disclosure may be filled out with “no known wells.” In cases where the existence of a well is uncertain, but there is a reasonable chance that a well is on the property (i.e., an abandoned farm site), the property owner should conduct an inspection, and if nothing is found have the property inspected by a knowledgeable person such as a licensed or registered contractor or local inspector. A metal detector can often locate a buried well in these situations. If no trace of a well can be found, but the property was not served by public water, had habitable buildings, and is located in an area where wells existed on other properties, then the MDH Well Management Section should be contacted for a final search and determination whether a variance is warranted. In cases where the existence of the well is certain, either through records or recollection, but the exact location is no longer known, the well should be disclosed as “not-in-use.” This will require that either the seller or buyer resolve the situation by finding and sealing the well, or if it cannot be found or sealed, obtaining a variance.

The property owner must locate the well and have it sealed, put it back into use, or get an unlocated well variance. This can be done by either the seller or the buyer of the property. Wells that cannot be located after a competent search has been made will not require a maintenance permit. They will remain on the property deed and in the MDH Well Management Section records as “unsealed” so that if there is a contamination problem in the area, demolition occurs, or other land use changes, steps can be taken to protect the groundwater. The approved variance must be filed with the property deed. The variance does not eliminate the property owner's responsibility to seal the well at such time it is found, or conditions require a more extensive search.

At a minimum, a visual search should be made for the well, or for evidence of a past well such as a water line, disconnected plumbing or electrical, outline of a pressure tank, or other clues. The location of other wells in the area may suggest the likely spot. The location of the pump, water lines, or a depression in the yard may indicate a well. City or county building records may have the well location marked, or a notation about connection to public water. Former owners, relatives, inspectors, neighbors, or other persons may remember the well location. A professional, such as well contractor, can do a visual search, and some can search with a metal detector or magnetic locator. If evidence points to the possible location of the well, excavation may be necessary. The excavation should typically extend below the frost line. It is recommended that the MDH Well Management Section be contacted before excavation is started.

The efforts made to locate a well, including receipts and invoices, should be carefully documented. If the well cannot be located after the conditions outlined by the MDH Well Management Section are met, then an unlocated well variance may be applied for.

### **INACCESSIBLE WELL OR BORING VARIANCE**

In some cases, additions, footings, or other obstructions make access, removal of obstructions, and sealing of wells and borings impossible without demolition of homes, buildings, or other structures. In cases of true inaccessibility, a variance may be granted to postpone well sealing requirements until the well becomes accessible. Variances are granted conditionally on maintenance of the well or boring, protection from contamination sources, placement of construction information on the property deed, and permanent sealing when the well or boring becomes accessible or becomes a threat to health or safety.

### **SEALING LIABILITY**

A well owner is not liable for contamination of groundwater from a well that occurs after the well is properly sealed and if the sealed well has not been disturbed.

A seller of property who fails to disclose the existence or known status of a well at the time of property transfer is liable to the buyer for sealing costs and reasonable attorney fees for a period of six years after the close of the property sale. This action must be brought by the buyer.

### **SEALING OF WELL PITS AND CISTERNS**

**Well pits and cisterns**, as long as the pit or cistern is not, or was not, a dug well, are not regulated by the rule. However, it is strongly recommended that the well pit or cistern be filled. At least one wall should be removed, the floor broken up if it is concrete or similar material, and the pit or cistern filled with native material no less permeable than the surrounding area. The pit or cistern is not required to be filled by a licensed contractor.

Well pits and cisterns pose serious **safety problems**. In 2001, a three-year old child in northwestern Minnesota drowned in an abandoned cistern. Tragedies such as this can be avoided by having well pits and cisterns filled.

### **“SEALED” WELLS OR BORINGS WITHOUT SEALING RECORDS**

The well and boring sealing report, signed by a representative of a licensed or registered contractor is the official record of proper sealing. In very limited cases in the past, **old wells or borings** were properly sealed and a report was not filed. In these instances, the MDH Well Management Section has accepted documentation such as contractor work records showing that the well or boring was properly sealed. However, more often than not, wells are found that appear to be sealed, that is, the casing is cut off at floor level with cement visible in the top of the casing, which are in fact not completely or properly sealed. Often a rag, newspaper, or other obstruction was forced a few inches or feet down the casing and the top capped with cement, leaving the remainder of the casing open. If a well or boring appears to be sealed, but no documentation exists, it is considered not to be properly sealed. In these cases, it is necessary to drill out the cement plug. The MDH Well Management Section should be contacted.

STAT AUTH: MS s 103I.101; 103I.111; 103I.205; 103I.221; 103I.301; 103I.401; 103I.451; 103I.501; 103I.525; 103I.531; 103I.535; 103I.541; 103I.621; 144.05; 144.12; 144.383; 157.04; 157.08; 157.09; 157.13

HIST: 17 SR 2773; 33 SR 211

## **4725.3875 RESPONSIBILITY FOR SEALING.**

*Subpart 1. Responsibility for sealing, general. A property owner is responsible for having a contractor licensed or registered in accordance with part 4725.0475 seal an unused well or boring except in accordance with subparts 2 and 5.*

A property owner or well owner may **not** personally seal a well or boring, including drive-points.

### **WHO MAY SEAL WELLS**

- A well contractor may seal any well.
- A well sealing contractor may seal any well.
- A monitoring well contractor may seal a monitoring well.
- A dewatering well contractor may seal a dewatering well.
- A limited drive-point and dug well contractor may seal a drive-point or dug well.

### **WHO MAY SEAL BORINGS**

- A well contractor may seal any boring.
- A well sealing contractor may seal any boring.
- A monitoring well contractor may seal an environmental bore hole.
- An elevator contractor may seal an elevator boring.

*Subp. 2. Corrective work. When a person, including a licensee or registrant seals a well or boring in violation of these rules, the person is responsible for sealing the well or boring in accordance with this chapter.*

*Subp. 3. Report of well or boring not in use. A licensee or registrant must report to the commissioner a well or boring that the licensee or registrant knows is not in use and is not sealed.*

*Subp. 4. Unsuccessful or “test” well or boring. An unsuccessful or “test” well or boring must be sealed in accordance with part 4725.3850 by the licensee or registrant who constructed the well or boring, unless the property owner has the well or boring sealed by another licensed or registered contractor, or completes the well or boring and places it in use.*

Unsuccessful or “test” wells or borings must be sealed as soon as drilling and testing is completed, and before the drilling machine leaves the property, unless the well and boring owner has contracted with another contractor to seal the well or boring.

*Subp. 5. Burial or building over an unsealed well or boring. A person who buries, or constructs a building over, an unsealed, unused well or boring is responsible for having the well or boring sealed by a licensed or registered contractor.*

*STAT AUTH: MS s 103I.101; 103I.111; 103I.205; 103I.221; 103I.301; 103I.401; 103I.451; 103I.501; 103I.525; 103I.531; 103I.535; 103I.541; 103I.621; 144.05; 144.12; 144.383; 157.04; 157.08; 157.09; 157.13*

*HIST: 17 SR 2773; 33 SR 211*

**4725.3900** *[Repealed, 17 SR 2773]*

**4725.4000** *[Repealed, 17 SR 2773]*



**End  
of  
Treatment, Repair, Sealing Section**

## **WATER-SUPPLY WELLS**

### **4725.4050 APPLICABILITY.**

*Parts 4725.4050 to 4725.6050 are standards that apply to water-supply wells in addition to the requirements in parts 4725.2010 to 4725.3875.*

This portion of the rules **applies only to water-supply wells**. Construction of water-supply wells must follow both the requirements in this section (Minnesota Rules, parts 4725.4050 through 4725.6050), and the general well and boring rules (Minnesota Rules, parts 4725.2010 through 4725.3875). If a requirement of the water supply rule, Minnesota Rules, parts 4725.4050 through 4725.6050 is more restrictive than a requirement of the general rules regulating all wells and borings (Minnesota Rules, parts 4725.2010 through 4725.3875), the more stringent standard must be followed.

Water-supply wells include all “wells” except monitoring and dewatering wells. Water-supply wells include wells used for private and public drinking water, irrigation, heat pump water supply, industrial or commercial use, air conditioning, and groundwater remediation.

*STAT AUTH: MS s 103I.101; 103I.111; 103I.205; 103I.221; 103I.301; 103I.401; 103I.451; 103I.501; 103I.525; 103I.531; 103I.535; 103I.541; 103I.621; 144.05; 144.12; 144.383; 157.04; 157.08; 157.09; 157.13*

*HIST: 17 SR 2773; 33 SR 211*

### **4725.4100 [Repealed, 17 SR 2773]**

### **4725.4150 BENTONITE DRILLING FLUIDS.**

*Bentonite drilling fluids used to construct or repair a water-supply well must have a measurable chlorine residual at all times during drilling or repair, except for a remedial well where chlorine will interfere with water quality analysis or remediation.*

Bentonite drilling fluids must contain chlorine at all times during drilling. The rules do not require a specific concentration, only that a measurable quantity exists. Chlorine concentrations can be easily measured to 1 part per million (1 ppm) or less with chlorine test strips or with a chlorine test kit. Because chlorine will be used up by organic and other material in the drilling fluid, chlorine will need to be added to the drilling fluid as drilling progresses, possibly as often as each time a drill rod is added to the drill string.

*STAT AUTH: MS s 103I.101; 103I.111; 103I.205; 103I.221; 103I.301; 103I.401; 103I.451; 103I.501; 103I.525; 103I.531; 103I.535; 103I.541; 103I.621;*

*HIST: 33 SR 211*

### **4725.4200 [Repealed, 17 SR 2773]**

## **4725.4250 LIMESTONE OR DOLOMITE WATER-SUPPLY WELLS.**

Limestone or dolomite bedrock in Minnesota consists of deposits of magnesium or calcium carbonate (lime) deposited in shallow seas from chemical precipitation or the remains of shells, and other sea life. Over 400 million years, the formations fractured, eroded, and in some instances developed cavities and caves. Limestone and dolomite can dissolve in weak acids, such as plant acids, creating interconnected drainage systems, and in the extreme, sinkholes, caverns, and the cave systems of southeastern Minnesota.

Water moves through sand or sandstone formations by slow movement through small pore spaces between sand grains. Water moves through limestone or dolomite through fractures, solution cavities, and in some cases, caves. A typical groundwater flow rate in sand is 100 to 200 feet in a year. Water can move 100 to 200 feet per minute through heavily fractured limestone or dolomite. Water movement through limestone and dolomite in southeastern Minnesota has been measured at over 3 miles in a day. This very rapid water flow, without the natural filtration provided by flow through a fine-grained porous media, makes wells completed in a limestone or dolomite highly susceptible to contamination. Since this filtration which removes microorganisms and attenuates chemical contaminants is often minimal in the limestone or dolomite, it must occur in the overlying materials before reaching the limestone or dolomite. Since the limestone or dolomite is susceptible to contamination, the construction of nonpotable water-supply wells is also of concern, so that the construction does not spread contamination.

*Subpart 1. **Applicability.** This part applies to water-supply wells, including private drinking water supply, public drinking water supply, irrigation, commercial, groundwater thermal exchange, and remedial wells completed in or below limestone or dolomite. This part does not apply to borings, monitoring wells, or dewatering wells.*

Limestone or dolomite formations include the Cedar Valley through Galena groups, Platteville formation, and Prairie du Chien group (Shakopee, New Richmond or Root Valley, and Oneota). The New Richmond or Root Valley is a thin sandstone layer within the Prairie du Chien, which occurs in some locations in southern Minnesota. It is considered part of the Prairie du Chien group and subject to the same restrictions as the Prairie du Chien for water-supply well construction.

*Subp. 2. **Plastic casing.** Plastic casing must not be used as an outside casing in a water-supply well cased more than five feet into limestone or dolomite bedrock, except that an inner plastic casing may be installed entirely inside an outer steel casing in accordance with part 4725.2250, subpart 8.*

If plastic casing is used to complete a well in limestone or dolomite bedrock the open hole must be drilled prior to casing installation. As required by Minnesota Rules, part 4725.2650, subpart 9a, the plastic casing must be extended 5 feet into the limestone or dolomite bedrock, and the annular space surrounding the casing in bedrock must be filled with neat-cement or cement sand grout. There is no bore hole size requirement if the limestone or dolomite formation is the uppermost bedrock. The rule is designed to assure a solid seal into the bedrock, but not allow plastic casing to extend so far that the casing may be deformed by excessive heat generated from cement grout in a large cavity.

*Subp. 3. **Bore hole size.** A casing that extends more than ten feet into limestone or dolomite bedrock must be installed in a bore hole a minimum of 3.0 inches larger, or 3.5 inches larger for casings deeper than 100 feet and larger than 12 inches inside diameter, than the outer diameter of the casing or couplings, whichever is larger.*

*Subp. 4. **Use of limestone or dolomite for potable supply.***

*A. A water-supply well used to provide potable water must not be completed in limestone or dolomite bedrock unless the limestone or dolomite bedrock is overlain by at least 50 feet of unconsolidated material, sandstone, or shale that extends in all directions around the well for a minimum one mile radius. Limestone or dolomite bedrock includes the Cedar Valley through Galena groups, Platteville formation, and the Prairie du Chien group.*

Subpart 4, A, concerns **potable water-supply wells** only.

In order to finish a potable water well in a limestone or dolomite formation, the limestone or dolomite formation must have at least 50 feet of unconsolidated materials (glacial drift, alluvium) or noncarbonate rock (sandstone or shale) over the limestone or dolomite formation **at the drill site and everywhere within a 1-mile radius** of the well site.

Many of the MGS's county atlases contain **maps** that illustrate well construction in limestone areas. In addition, the MDH Well Management Section has produced maps available to contractors, which illustrate well construction in some limestone areas not contained in the county atlas series. Geologic atlases and MDH limestone well construction maps will be available for additional counties in the future.

Any well connected to **plumbing fixtures** (toilets, sinks, hose bibs, etc.) in a dwelling, or connected to plumbing fixtures where water is available for human consumption or human contact is considered a potable supply.

*B. The commissioner may establish limestone and dolomite bedrock well construction maps identifying areas of known or suspected contamination, areas with unique hydrologic or geologic conditions, or areas where protective conditions exist, including low permeability overlying materials, favorable groundwater gradients, or reduced contaminant loading in recharge areas. The conditions in item A do not apply in areas designated as approved for drilling on the limestone and dolomite bedrock well construction maps published by the commissioner.*

*Subp. 5. **Water-supply well completed in limestone or dolomite.** Where a potable water-supply well meeting the conditions of subpart 4 or a non-potable water-supply well, is completed in limestone or dolomite bedrock, the following apply.*

*A. If the static water level in the well is more than ten feet above the limestone or dolomite:*

(1) steel casing must be installed into the limestone or dolomite by driving the casing with a drive shoe through unconsolidated materials or sandstone into, but not more than ten feet into, the limestone or dolomite; or

(2) a bore hole must be drilled into the limestone or dolomite and steel casing installed to the bottom of the bore hole. If the bore hole extends more than ten feet into the limestone or dolomite, the bore hole must be a minimum of 3.0 inches larger, or 3.5 inches larger for casings deeper than 100 feet and larger than 12 inches inside diameter, than the outside diameter of the casing or couplings, whichever is larger. The annular space surrounding the casing must be grouted from the bottom of the casing to the top of the bedrock with neat-cement grout or cement-sand grout. The unconsolidated materials portion of the annular space must be grouted according to part 4725.3050, subparts 1 to 3.

B. If the static water level in the well is less than ten feet above the limestone or dolomite, a bore hole must be drilled a minimum of 3.0 inches larger, or 3.5 inches larger for casings deeper than 100 feet and larger than 12 inches inside diameter, than the outside diameter of the casing or couplings, whichever is larger. The bore hole must extend a minimum of 20 feet below the static water level. Steel casing must be installed to the bottom of the bore hole. The annular space from the bottom of the casing to the top of bedrock must be filled with neat-cement grout or cement-sand grout. The unconsolidated materials portion of the annular space must be grouted according to part 4725.3050, subparts 1 to 3.

A **nonpotable** water-supply well, such as an irrigation well, completed in limestone or dolomite does not require 50 feet of unconsolidated material or firm insoluble rock that extends around the well or boring for a 1-mile radius.

**Subp. 6. Water-supply well completed below limestone or dolomite.** A water-supply well completed below limestone or dolomite where the conditions of subpart 4 apply must be constructed by drilling a bore hole a minimum of 3.0 inches larger, or 3.5 inches larger for casings deeper than 100 feet and larger than 12 inches inside diameter, than the outside diameter of the casing or couplings a minimum of ten feet below the limestone or dolomite, and a minimum of ten feet below the static water level. Steel casing must be installed to the bottom of the bore hole, and the annular space from the bottom of the casing to the top of bedrock must be filled with neat-cement grout or cement-sand grout. The unconsolidated materials portion of the annular space must be grouted according to part 4725.3050, subparts 1 to 3.

Subpart 6 concerns **water-supply wells completed below a limestone or dolomite** formation where the limestone or dolomite cannot be used for a potable water supply. This subpart applies to wells completed in the St. Peter sandstone underlying the Platteville limestone, or wells completed in the Jordan sandstone underlying the Prairie du Chien limestone. The casing must extend at least 10 feet into the St. Peter

sandstone or Jordan sandstone and 10 feet below the static water level. Since these wells are completed in a sandstone formation, only 10 feet of sandstone or equivalent is necessary to remove microbiological contaminants that may be in the limestone or dolomite.

Subparts 5 and 6 of this part allow the annular space in unconsolidated materials to be sealed with cuttings taken from the bore hole except for the top 50 feet which must be sealed by pumping neat cement, sand-cement, or bentonite grout into the annular space.

***Subp. 7. Remedial well in limestone or dolomite.*** *A remedial well is exempt from the requirement in subpart 5 to extend the casing 20 feet below the static water level if the well screen or open hole intersects the water table, the casing terminates no more than ten feet above the static water level, and all casing installed in limestone or dolomite is grouted with neat-cement grout or cement-sand grout.*

***STAT AUTH: MS s 103I.101; 103I.111; 103I.205; 103I.221; 103I.301; 103I.401; 103I.451; 103I.501; 103I.525; 103I.531; 103I.535; 103I.541; 103I.621;***  
***HIST: 33 SR 211***

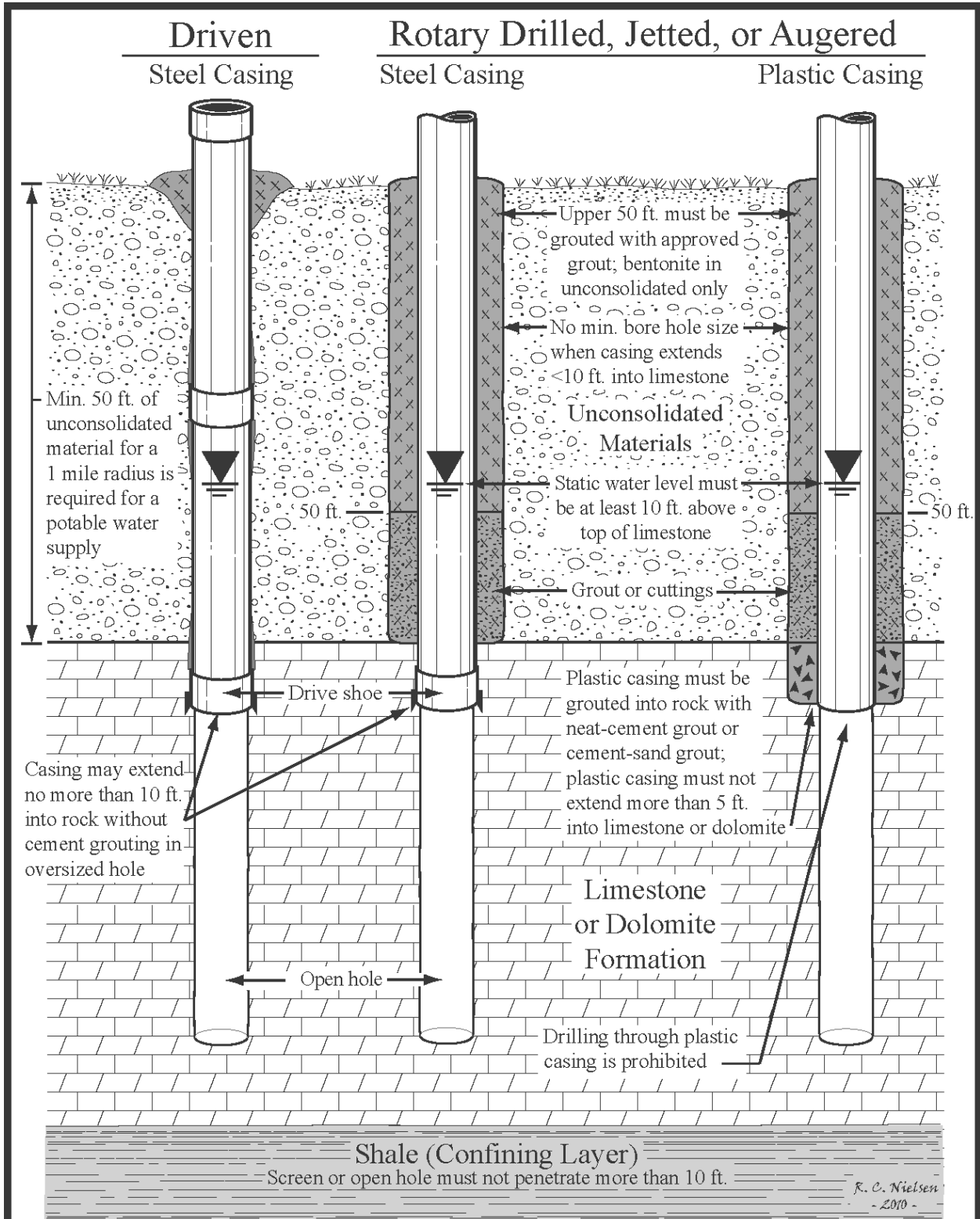

\* Note: See additional requirements for flowing wells.

Figure 22. Water-Supply Wells in Limestone Where Static Water Level is at Least 10 Feet Above Limestone\*

# Rotary Drilled, Jetted, or Augered

## Steel Casing

Plastic casing is not allowed

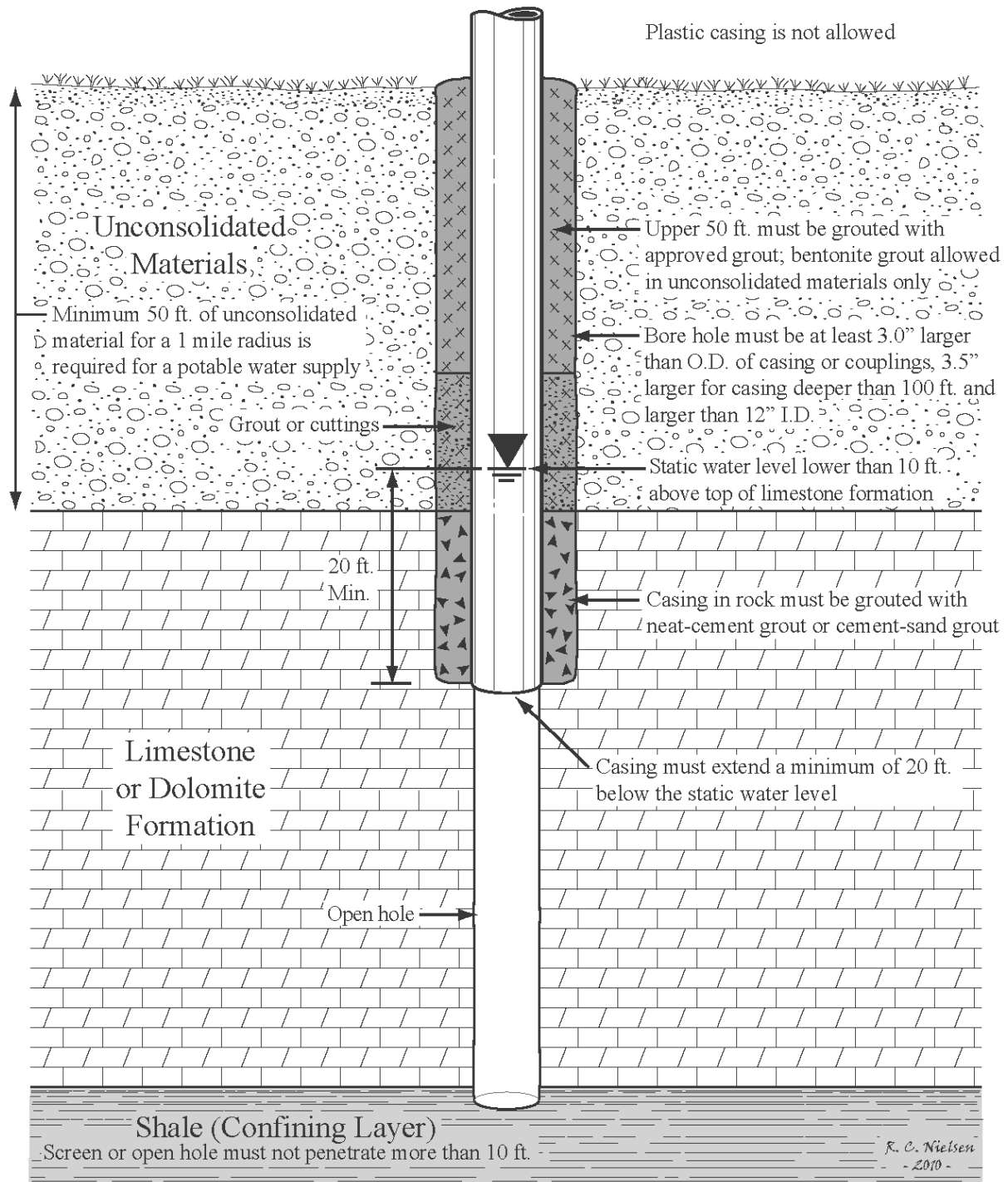
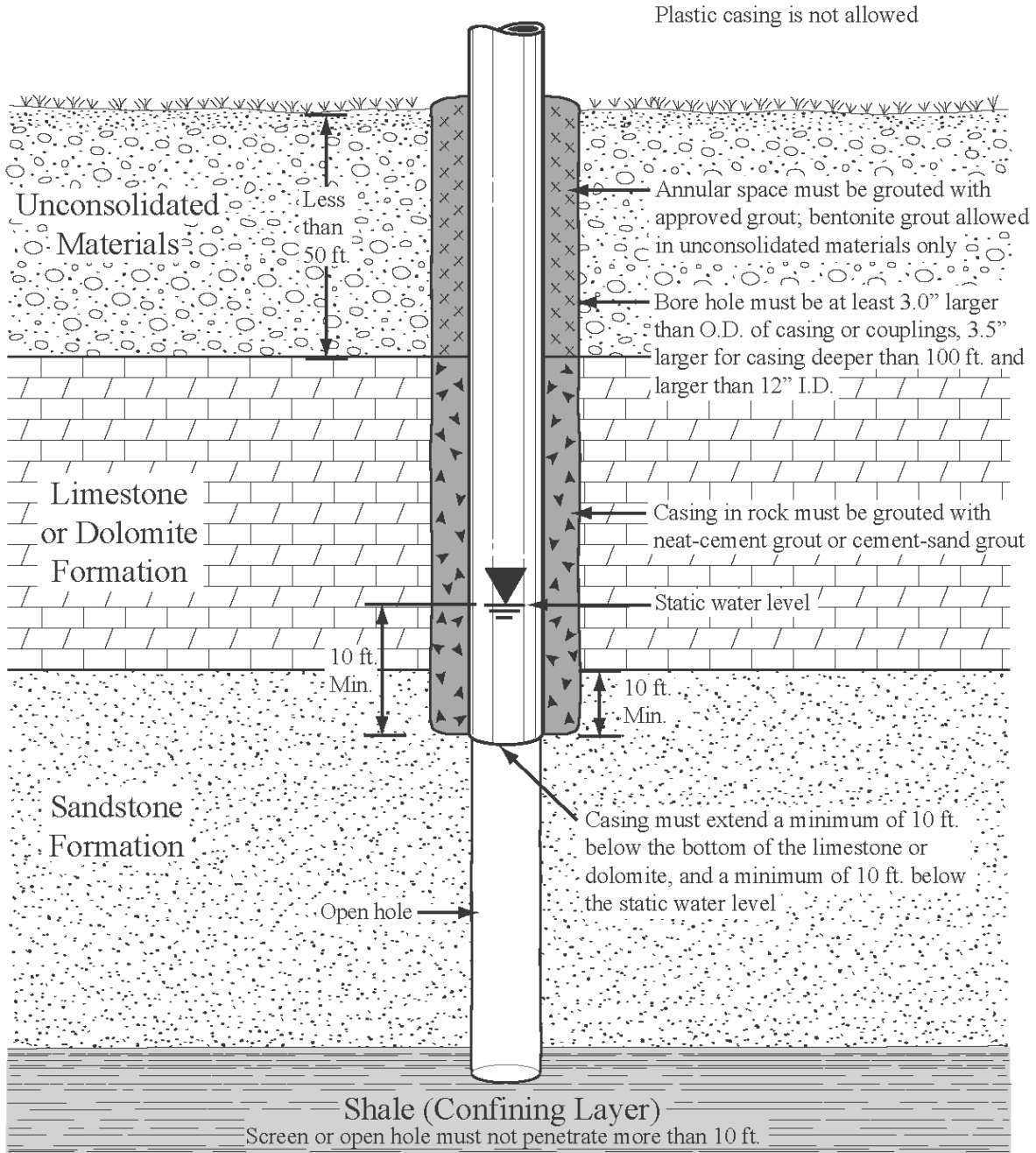

Figure 23. Water-Supply Wells in Limestone Where Static Water Level is Less Than 10 Feet Above Limestone



## Rotary Drilled, Jetted, or Augered Steel Casing



\* Note: See additional requirements for flowing wells.

*R. C. Nielsen*  
- 2010 -

Figure 24. Potable Water-Supply Wells With Less Than 50 Feet to Limestone or Dolomite\*

**4725.4300 [Repealed, 17 SR 2773]**

**4725.4350 WATER-SUPPLY WELL DISTANCE FROM WATER BODIES;  
PROTECTIONS IN FLOOD AREAS.**

*Subpart 1. Distance from water bodies. The minimum horizontal distance between a water-supply well and the ordinary high water level of a stream, river, pond, storm water retention pond, or lake is 35 feet. The isolation distance does not apply to:*

*A. an area protected by a flood control structure accepted by the United States Federal Emergency Management Agency (FEMA), as designated on a FEMA flood map;*

*B. a wetland, grassed waterway, depression, culvert, or ditch holding water less than six months of the year; or*

*C. an artificial pond holding less than 5,000 gallons of water.*

The ordinary high-water level is often the top of a stream or lake bank, denoted by trees such as oaks or maples which will not survive flooding. The existing water level or shoreline is often **not** the ordinary high-water level. The ordinary high-water level of many lakes is available from the DNR or local governments.

It is important to measure the distance horizontally, not along the slope.

**Artificial ornamental ponds** holding less than 5,000 gallons are not included in the 35-foot distance requirement. Ditches, swales, grassed waterways, or culverts are not required to be 35 feet from a well unless the depression contains water more than six months of the year.

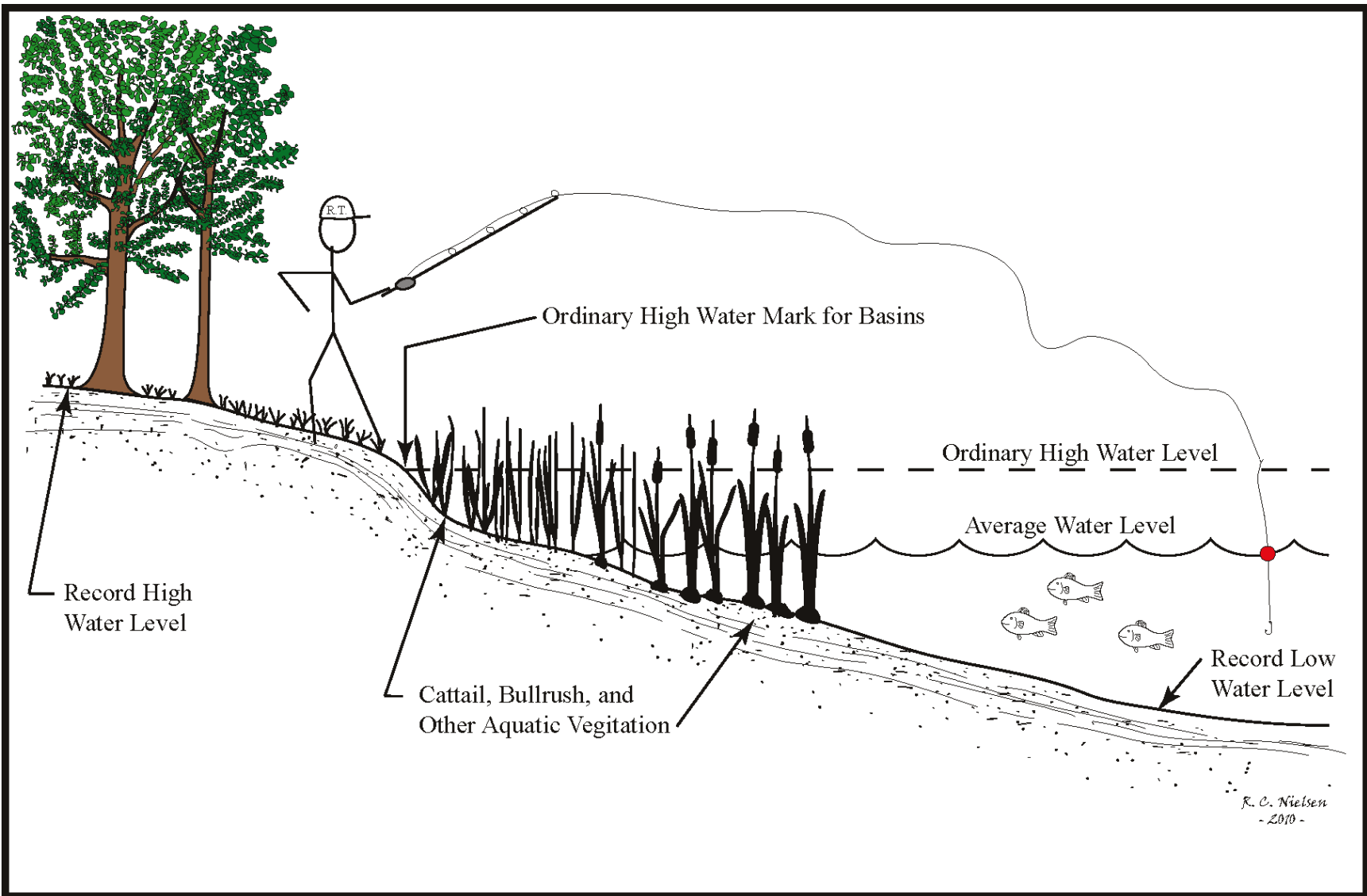

Figure 25. Ordinary High Water Level

*Subp. 2. **Flood protection.** A water-supply well must be constructed to prevent the entry of flood water into the well by:*

- A. extending the casing at least five feet above the regional flood level;*
- B. installing a watertight seal and extending the casing ten feet above the established ground surface, if the regional flood level is more than five feet above the established ground surface;*
- C. installing an outer, neat-cement grouted protective casing in accordance with part 4725.6755 subpart 2, item B, extending the protective casing and well casing a minimum of two feet above the established ground surface, and installing a waterproof threaded cap or a waterproof compression seal with drawbolts and a one-piece top plate on both casings; or*
- D. extending the casing a minimum of two feet above the established ground surface, installing a sealed spool, or flowing well pitless unit, and installing a waterproof, nonvented compression seal.*

*The requirements in this subpart do not apply to a water-supply well located in an area protected by a flood control structure accepted by the United States Federal Emergency Management Agency (FEMA), as designated on a FEMA flood map*

“**Regional flood level**” is defined in Minnesota Statutes, section 103F.111, subdivision 10, to mean a flood that is representative of large floods known to have occurred generally in the state and reasonably characteristic of what can be expected to occur on an average frequency in the magnitude of a 100-year-recurrence interval. The regional flood is often referred to as the “**100-year flood.**” This is the flood used for most building codes and flood insurance determinations.

“Established ground surface” is defined in Minnesota Rules, part 4725.0100, subpart 28, to mean the intended or actual finished grade (elevation) of the surface of the ground at the site of a well or boring.

The requirement to extend the casing 5 feet above the regional flood level applies only to water-supply wells located within the designated 100-year flood plain. This is the area marked on FEMA maps.

Maps designating the areas of regional flood plains and flood level information may be available from county zoning administrators, insurance agents, U.S. Army Corps of Engineers, DNR, MDH, and others.

If a watertight seal is installed in lieu of extending the casing more than 10 feet above the established ground surface, a vent must not be installed.

*STAT AUTH: MS s 103I.101; 103I.111; 103I.205; 103I.221; 103I.301; 103I.401; 103I.451; 103I.501; 103I.525; 103I.531; 103I.535; 103I.541; 103I.621; 144.05; 144.12; 144.383; 157.04; 157.08; 157.09; 157.13*

*HIST: 17 SR 2773; 33 SR 211*

**4725.4400** [Repealed, 17 SR 2773]

**End  
of  
Water-Supply Wells, Limestone, Flooding Section**

## **4725.4450 WATER-SUPPLY WELL DISTANCES FROM CONTAMINATION SOURCE.**

The rules contain minimum “isolation,” or “setback” distances between sources of contamination and a water-supply well. The distances apply to all water-supply wells, including irrigation or other “nonpotable” water-supply wells, industrial supply wells, and sandpoints. The distances are designed to protect the well by providing distance and time for contaminants to attenuate or dilute before reaching the well.

The rules regulate the location of a well near a source of contamination and the placement of a contamination source near a well. This latter requirement is a provision of Minnesota Statutes, section 103I.205, subdivision 6.

The rules require that the isolation distance to a **sensitive well** is doubled where a contaminant is (actively) entering the soil. A “sensitive well” is a well with less than 50 feet of watertight casing which is not cased through 10 feet of confining materials. The distance between a sensitive well and a drainfield is doubled from 50 feet to 100 feet since the partially treated sewage is entering the soil. The distance is not doubled to a septic tank since sewage should not be leaking from the tank under normal operation.

The rules establish the isolation numbers based on the potential threat. Sources that routinely leak, sources with more dangerous chemicals, or sources with larger volumes have greater distances. In some cases, the rules contain a **tiered** system, such as the 300-foot distance to a soil dispersal system (drainfield) receiving more than 10,000 gallons per day of sewage, a 150-foot distance to a system receiving infection or pathological wastes, such as from a hospital, and a 50-foot distance to the remaining small systems.

*Subpart 1. Isolation distances. A water-supply well must be located where there is optimum surface drainage and at the highest practical elevation. Whenever possible, water-supply wells should not be located down slope or down gradient of a contamination source. A water-supply well must be constructed as far as practical from a contamination source, but no less than the distances in this part.*

*The isolation distances in this part are minimum distances measured horizontally from the closest part of the upper termination of the water-supply well casing to the closest part of the contamination source, or the vertical projection of the contamination source on the established ground surface, whichever is closer.*

The isolation distances are minimum standards. Whenever possible, greater distances are recommended.

*Where the rule establishes a minimum regulatory volume of a liquid, the volume of multiple tanks, each below the minimum, are not additive, unless the tanks are interconnected without backflow protection.*

*The minimum isolation distances must be maintained between a new well and a source of contamination no longer in use, unless all contaminants have been removed from the source, and visibly contaminated soils have been removed.*

*A contamination source must not be placed, constructed, or installed any closer to a water-supply well than the distances in this part.*

Ideally, a well should be placed **upgradient** of all nearby contamination sources. Practically, the best location should be chosen to minimize the contamination potential for the well. In most cases on lakeshore lots, groundwater flows toward the lake. The well should be placed on the high side of the property, upslope of the septic system.

This rule requires that drainage be away from the well and that surface water not pond around the well. It also requires the well to be placed on the highest practical elevation on the property while maintaining the required isolation distances. The well must be placed at the highest location on the property that meets all isolation distances, provides for proper drainage, and allows for installation and service of the well.

**Local government** units cannot regulate the construction or location of wells unless the program has been delegated from the MDH. However, they can regulate land use and other activities such as the placement of septic systems. Some local programs require greater separation distances than required in these rules when a contamination source is added near an existing well.

An alphabetical list of the isolation distances is contained at the end of this rule part.

*A water-supply well must be no less than:*

*A. 300 feet from:*

*(1) the absorption area of a soil dispersal system with an average design flow greater than 10,000 gallons per day;*

A soil dispersal system consists of a drainfield, bed, mound, trench, drip or other configuration where sewage effluent is applied to the soil for treatment and disposal. Soil dispersal systems treating less than 10,000 gallons per day are regulated under MPCA Rules, Chapters 7080 – 7083, and local ordinances. Permitting and inspection is done by the local government, not by the MPCA. Soil dispersal systems that treat more than 10,000 gallons per day are not regulated by the local government, but by the MPCA. These systems require a State Disposal System permit.

The rules have three different isolation distances to soil treatment systems: 300 feet to these large systems, 150 feet to systems receiving infectious or pathological wastes, and 50 feet to mid-size and individual systems.

*(2) a landfill or a dump containing mixed municipal solid waste from multiple persons, except for a disposal area of household solid waste from a single residence regulated by item E, subitem (20);*

*(3) a permitted demolition debris landfill, except for a disposal area for construction debris or demolition debris regulated by item E, subitem (19);*

- (4) a municipal or industrial wastewater rapid infiltration basin;*
- (5) a municipal wastewater stabilization pond with 500 or more gallons/acre/day of leakage; and*

A “**stabilization pond**” is a pit, pond, tank, or lagoon into which sewage from a community system is discharged, and in which aerobic treatment occurs.

- (6) a liquid manure storage basin or lagoon that is unpermitted or noncertified according to chapter 7020; except that the minimum distance to a sensitive water-supply well is increased for subitems (1) to (6) to 600 feet as provided in subpart 2;*

The rules have three different isolation distances to manure storage basins or lagoons: 300 feet to these systems that have no liner or protection (MPCA rules require these to be upgraded or eliminated by 2010); 150 feet to basins or lagoons with an approved earthen liner; and 100 feet to basins or lagoons with a concrete or synthetic liner.

Detailed monitoring and hydrologic studies are needed in order to determine the horizontal and vertical extent of a contamination plume, or area of groundwater contamination. The plume from a large landfill or stabilization pond may extend hundreds or even thousands of feet from the waste site, well past the minimum 300-foot setback. Without detailed information, some safety is afforded by placing a well upgradient of the suspected groundwater flow direction and grouting the casing through a confining layer. The MPCA, MDA (agricultural chemical releases), and county solid or hazardous waste officials may have information relating to hydrogeology and contaminant occurrence at a waste site.

**B. 150 feet from:**

- (1) a tank or container holding:
  - (a) 25 gallons or more, or 100 pounds or more dry weight, of an agricultural chemical, or an area used to fill or clean agricultural chemical application equipment with these quantities, not protected with safeguards;**

An “agricultural chemical” is defined in Minnesota Statutes, section 18D.01, subdivision 3, to mean a pesticide as defined under Minnesota Statutes, Chapter 18B or a fertilizer, agricultural liming material, plant amendment, or soil amendment as defined under Minnesota Statutes, Chapter 18C.

The most common agricultural chemicals are fertilizers. The most common pesticides are herbicides.

Please take note that the minimum regulated quantity of agricultural chemicals is 25 gallons, while the minimum regulated quantity of petroleum or hazardous materials is 56 gallons.

“Safeguards” are protective measures designed to prevent the chemical release (leak or spill) and are found in MDA law and rule.

“**Pesticide**” is defined in Minnesota Statutes, section 18B.01, subdivision 18, to mean a substance or mixture of substances intended to prevent, destroy, repel, or mitigate a pest, and a substance or a mixture of substances intended for use as a plant regulator, defoliant, or desiccant.



“**Fertilizer**” is defined in Minnesota Statutes, section 18C.005, subdivision 11, to mean a substance containing one or more recognized plant nutrients that is used for its plant nutrient content and designed for use or claimed to have value promoting plant growth. Fertilizer does not include animal and vegetable manures that are not manipulated, marl, lime, limestone, and other products exempted by rule by the commissioner. Anhydrous ammonia tanks require a 50-foot separation.

“**Agricultural liming material**” is defined in Minnesota Statutes, section 118C.531, subdivision, 2 to mean materials whose calcium or magnesium compounds, or both, account for an ENP of 20 percent or more and includes, but is not limited to, burnt lime, hydrated lime, industrial by-product, limestone, and marl.

“**Plant amendment**” is defined in Minnesota Statutes, section 18C.005, subdivision 25, to mean a substance applied to plants or seeds that is intended to improve germination, growth, yield, product quality, reproduction, flavor, or other desirable characteristics of plants except fertilizers, soil amendments, agricultural liming materials, pesticides, and other materials that are exempted by rule.

“**Soil amendment**” is defined in Minnesota Statutes, section 18C.005, subdivision 33, to mean a substance intended to improve the physical characteristics of the soil, except fertilizers, agricultural liming materials, pesticides, and other materials exempted by the commissioner's rules.

The 150-foot distance can be reduced to 100 feet if safeguarded, and reduced to 50 feet if safeguarded and covered with a roof.

The distance applies to “pure” products and to mixed or diluted products if the chemical concentration in the mixture or dilution exceeds a water quality standard such as a Health Risk Limit (HRL) or MCL.

*(b) 56 gallons or more, or 100 pounds or more dry weight, of a hazardous substance not protected with safeguards; or*

Information about hazardous substances is located after Minnesota Rules, part 4725.0100, subpart 30c.

The 150-foot distance can be reduced to 100 feet if safeguarded.

*(c) 1100 gallons or more of petroleum not protected with safeguards as specified in chapter 7150 or 7151;*

The petroleum setbacks are dependant on the volume and safeguarding. A summary is located after Minnesota Rules, part 4725.4450, subpart 1, item E, subitem (9).

*(2) the absorption area of a soil dispersal system serving a facility such as a hospital, nursing home, mortuary, veterinary clinic, health care clinic or similar facility handling infectious or pathological wastes, except as provided in item A, subitem (1), and except that the minimum distance to a sensitive water-supply well is increased to 300 feet as provided in subpart 2;*

The setback to a soil dispersal system (sewage drainfield or mound) depends on the volume (over 10,000 gallons per day has a 300-foot setback), whether it serves a facility with a high percentage of infectious wastes (which have a 150-foot setback) or is less than 10,000 gallons per day and does not serve such a facility (in which case the setback is 50 feet).

(3) a municipal wastewater stabilization pond with less than 500 gallons/acre/day leakage, except that the minimum distance to a sensitive water-supply well is increased to 300 feet as provided in subpart 2;

(4) an industrial wastewater stabilization pond, except that the minimum distance to a sensitive water-supply well is increased to 300 feet as provided in subpart 2;

(5) a municipal or industrial wastewater spray irrigation area, except that the minimum distance to a sensitive water-supply well is increased to 300 feet as provided in subpart 2; and

(6) a liquid manure storage basin or lagoon that does not have a concrete or composite liner, but has an earthen liner that was constructed under a Minnesota Pollution Control Agency permit or is certified according to chapter 7020, except that the minimum distance to a sensitive water-supply well is increased to 300 feet as provided in subpart 2.

**C. 100 feet from:**

(1) a solid manure storage area not covered with a roof, except that the minimum distance to a sensitive water-supply well is increased to 200 feet as provided in subpart 2;

(2) a safeguarded area used to store agricultural chemicals, or clean or fill agricultural chemical application equipment that is protected with safeguards as defined in parts 1505.3010 to 1505.3150 for bulk pesticides, or with safeguards as specified in standards of the Department of Agriculture for fertilizers under parts 1510.0370 to 1510.0408 and Minnesota Statutes, chapter 18C;

The pesticide safeguard rules:

- Establish standards for storage containers and fittings;
- Require gauging devices;
- Require secured valves;
- Require secondary containment for liquid storage containers consisting of a wall and liner, basin, or other approved safeguards capable of containing the total volume of released product; and
- Establish standards for containment walls, liners, and basins.

“**Safeguard**” is defined in MDA Rules, part 1510.371, subpart 9, to mean a device, structure, or system or a combination of these designed to prevent the escape or movement of a liquid commercial fertilizer from the place it is stored which might result in the pollution of any surface or groundwaters.

The isolation distance is measured between the closest part of the well and the closest part of the chemical tank or mixing area. The distance is not measured from the containment basin.

*(3) an underground storage tank holding 56 or more gallons, or 100 pounds dry weight, of a hazardous substance, or with more than 1100 gallons of petroleum, if protected with safeguards as defined in chapter 7150;*

MPCA Rules, Chapter 7150, establishes the safeguarding standards for underground storage tanks. The rules are relatively detailed and should be referenced. In general, the rules establish standards for new tanks, upgrading existing tanks, operating requirements, corrosion protection, and release detection. The standards for new tanks and existing tank upgrades include: tank corrosion protection requirements, piping corrosion protection requirements, and spill and overflow prevention requirements. Underground petroleum tanks must be monitored at least every 30 days for releases. Hazardous-material underground tanks must be equipped with leak detection and secondary containment such as double walled-tanks or external liners.

“**Safeguard**” is defined in MPCA Rules, part 7100.0010, subpart 2, to mean a facility or device or any system or combination thereof designed to prevent the escape or movement of any substance or solution thereof from the place of storage or keeping thereof under such conditions that pollution of any waters of the state might result therefrom.

MPCA Rules, Chapter 7100 requires safeguards to include a continuous dike or wall surrounding the tanks or containment facility which will hold all of the tank contents in case of failure, and which has a bottom which will prevent seepage of the contaminant into the ground.

Information concerning underground and aboveground storage tanks, including safeguarding requirements, may be found at [www.pca.state.mn.us/index.php/waste/waste-and-cleanup/waste-management/tank-compliance-and-assistance/storage-tank-publications.html](http://www.pca.state.mn.us/index.php/waste/waste-and-cleanup/waste-management/tank-compliance-and-assistance/storage-tank-publications.html).

*(4) an aboveground storage tank with 56 or more gallons, or 100 pounds dry weight, of a hazardous substance, or with more than 1100 gallons of petroleum, if protected with safeguards as defined in chapter 7151;*

*(5) a liquid manure storage basin or lagoon with a concrete or composite liner in accordance with chapter 7020, except that the minimum distance to a sensitive water-supply well is increased to 200 feet as provided in subpart 2;*

*(6) an unroofed animal feedlot holding 300 or more animal units, except that the minimum distance to a sensitive water-supply well is increased to 200 feet as provided in subpart 2;*

#### **ANIMAL CONFINEMENT ISOLATION SUMMARY**

<u>Distance</u>	<u>Contamination Source</u>
300 feet	Unroofed feedlot with 300 or more animal units
50 feet	Roofed feedlot with 300 or more animal units, or an unroofed feedlot with more than 1.0 and less than 300 animal units
20 feet	A confinement area with 0.1 to 1.0 animal units
No setback	Less than 0.1 animal unit

*(7) tanks, vessels, or components of a wastewater treatment unit; and*

A **wastewater treatment unit** is defined in the definitions section, but generally means a component or part of a wastewater treatment plant.

*(8) a pipeline used to transport petroleum to a petroleum refinery or distribution center;*

The 100-foot distance applies to a petroleum (distribution) pipeline. Pipes conveying petroleum from commercial, farm, or residential tanks on a property must be 50 feet from a water-supply well.

*D. 75 feet from a cesspool, seepage pit, leaching pit, or dry well, except that the minimum distance to a sensitive water-supply well is increased to 150 feet as provided in subpart 2;*

“**Cesspool**” is defined in Minnesota Rules, part 4725.0100, subpart 23, to mean an underground pit into which raw household sewage or other untreated liquid waste is discharged and from which the liquid seeps into the surrounding soil.

“**Seepage pit, leaching pit, or dry well**” is defined in Minnesota Rules, part 4725.0100, subpart 43, to mean an underground pit into which a sewage tank discharges effluent or other liquid waste and from which the liquid seeps into the surrounding soil through the bottom and openings in the side of the pit.

“**Dry well**” is another term describing a cesspool or seepage pit. The term does not refer to a water well which is dry.

Subpart 2 requires a 150-foot distance between a cesspool, seepage pit, leaching pit, or dry well and a water-supply well which does not have 50 feet of watertight casing or which does not penetrate 10 feet of a confining layer.

*E. 50 feet from:*

*(1) a safeguarded area used to store agricultural chemicals, or fill or clean agricultural chemical application equipment that is covered with a permanent watertight roof and protected with safeguards as defined in parts 1505.3010 to 1505.3150 for bulk pesticides, or with safeguards as specified in standards of the Department of Agriculture for fertilizers under parts 1510.0370 to 1510.0408 and Minnesota Statutes, chapter 18C;*

*(2) an animal feedlot holding more than one animal unit, except as provided in item C, subitem(6), and except that the minimum distance to a sensitive water-supply well is increased to 100 feet as provided in subpart 2;*

One animal unit equals one steer or horse or 1,000 pounds of animals.

*(3) a feeding or watering area within a pasture holding more than one animal unit, except that the minimum distance to a sensitive water-supply well is increased to 100 feet as provided in subpart 2;*

*(4) an animal or poultry building, including a horse riding arena, holding more than one animal unit, except that the minimum distance to a sensitive water-supply well is increased to 100 feet as provided in subpart 2;*

“**Animal or poultry building**” means any temporary or permanent structure utilized, and designed or constructed for the intended or actual use of sheltering animals or poultry. The animal or poultry building includes all portions of a structure in which animals are, or are intended to be, sheltered. Office areas, storage areas, or other clearly separated portions of multi-use structures which do not house animals are not considered part of the “animal building.”

Subpart 2 requires a 100-foot separation between an animal or poultry building and a water-supply well with less than 50 feet of watertight casing or that does not penetrate 10 feet of a confining layer.

*(5) an interceptor, including a flammable waste or sediment interceptor;*

“**Interceptor**” is defined in the Minnesota Plumbing Code, part 4715.0100, to mean a device designed and installed so as to separate and retain deleterious, hazardous, or undesirable matter from normal wastes while permitting normal sewage or liquid wastes to discharge into the drainage system by gravity.

Flammable-waste interceptors and sediment interceptors are the most common types of interceptors.

*(6) a human grave, mausoleum, or area used to bury more than one animal unit.*

*(7) the absorption area of a soil dispersal system except as provided in items A, subitem (1), and B, subitem (2), or a privy, except that the minimum distance to a sensitive water-supply well is increased to 100 feet as provided in subpart 2;*

A “**soil dispersal system**” includes drainfields, seepage beds, sewage mounds, and other configurations to disperse, treat, and dispose of sewage into the soil. The isolation distance is measured from the closest part of the well to the closest part of the soil treatment area. In the case of a drainfield or bed, it is the closest sidewall of the trench or bed. In the case of a mound, it is the closest edge of the absorption area. The absorption area of a mound is the calculated area of sand underlying the rock bed designed to absorb effluent. If the edge of the absorption area cannot be determined, the distance will be measured from the toe of the mound.

Subpart 2 requires a 100-foot separation between a soil treatment system or a privy and a water-supply well with less than 50 feet of watertight casing or which does not penetrate 10 feet of a confining layer

*(8) a septic tank, sewage sump except as provided in item G, subitem (1), watertight sewage treatment device except as provided in item C, subitem (7), or watertight sewage holding tank;*

The definitions of “**septic tank**” and “**holding tank**” are found in the definitions section, Minnesota Rules, part 4725.0100. Septic tanks and holding tanks are receptacles designed to be watertight and to hold sewage. Sewage tanks which are not watertight (cesspools, dry wells, leaching pits) are required to be 75 feet from a nonsensitive water-supply well.

A “**sewage sump**” is a tank which receives sewage and which is equipped with a pump. Sewage sumps include lift stations, ejector baskets, pump tanks and compartmentalized tanks with pumps. A sewage sump is a sealed tank containing a pump that discharges sewage to a soil dispersal system or to a public sewer. Item G, subitem (1), allows a 20-foot distance to some sewage sumps as explained later.

A watertight sewage treatment device is a tank or receptacle such as an aeration tank used to treat sewage associated with a subsurface sewage treatment system (SSTS). It is differentiated from a wastewater treatment unit, Item C, subitem (7), which requires a 100-foot distance.

***(9) a buried storage tank holding between 56 and 1,100 gallons of petroleum;***

A heating oil or other petroleum tank between 56 and 1,100 gallons **located in a basement** or other underground room where the tank is not buried is not considered to be buried. These tanks must be located a minimum of 20 feet from a well.

To summarize the petroleum tank isolation distance requirements:

**PETROLEUM TANK ISOLATION DISTANCE SUMMARY**

<u>PETROLEUM TANK SIZE</u>	<u>ISOLATION DISTANCE</u>
● Tanks over 1,100 gallons	150 feet without MPCA safeguards 100 feet with safeguards
● Tanks 56 to 1,100 gallons	50 feet for below-ground tanks 20 feet for above-ground tanks
● Tanks 56 gallons or less	No required distance, but 50 feet recommended

The **buried piping** carrying the petroleum from the tanks must be 50 feet from the well, regardless of the volume or safeguarding of the tank.

***(10) an unused, unsealed well or boring;***

A 50-foot separation is required between a water-supply well and an unused, unsealed well or boring.

A 20-foot separation is required between an in use water-supply well and a pit, including another in use well in a well pit. **The rules do not require a separation between two properly constructed water-supply wells.** However, separation is recommended to prevent damage or interference to one or both wells.

Separation is not required between a properly sealed well and a water-supply well.

*(11) a source of pollution or contamination that may drain into the soil except as provided in this part;*

This provision requires a 50-foot separation between a water-supply well and a pollution or contamination source not directly identified in the rules. If a source is suspected to meet the definition of “pollutant, contaminant, or hazardous substance,” the 50-foot distance should be maintained or the MDH Well Management Section should be contacted. The MDH will identify facilities or situations which meet the 50-foot separation requirement in the Minnesota Well Management News newsletter.

Minnesota Statutes, section 115B.02 defines “**pollutant or contaminant**” as: any element, substance, compound, mixture, or agent other than a hazardous substance, which after release from a facility and upon exposure of, ingestion, inhalation, or assimilation into any organism, either directly from the environment or indirectly by ingestion through food chains, will or may reasonably be anticipated to cause death, disease, behavioral abnormalities, cancer, genetic mutation, physiological malfunctions (including malfunctions in reproduction) or physical deformations, in the organisms or their offspring. This does not include natural gas, natural gas liquids, liquefied natural gas, synthetic gas usable for fuel, or mixtures of such synthetic gas and natural gas.

*(12) a buried sewer, except as provided in item G, subitem (5) that:*

*(a) serves as a collector or municipal sewer;*

*(b) is open-jointed; or*

*(c) is constructed of materials that do not meet the specifications, methods, and testing protocol in parts 4715.0530 and 4715.2820;*

A “sewer” is any pipe, piping material, hose, or conduit whether horizontal, vertical, or at any angle which contains sewage or is connected to piping which contains sewage. “Sewage” includes gray-water systems that receive wastewater from sinks, floor drains, or washing machines. Buried sewers connected to floor drains, stacks, or other parts of the drain, waste, and vent systems are included. Buried sewers both inside and outside the building are included.

A **sewer does not include** building footing drains (drain tile) if the footing drains are not connected to piping which contains sewage, and if sewage cannot back up into the drain.

A **sewer which is not buried** is not required to meet the 50-foot distance; however, it is recommended.

A “collector” is a sewer connecting more than one building sewer, such as the sewer that connects two homes to a common drainfield. A “**municipal sewer**” (often referred to as the sewer “main”) is a sewer which connects building sewers to a municipal sewage treatment system. The collector or municipal sewer includes only the portions of the sewer downstream of the individual building sewers. A 50-foot separation is required from all collector or municipal sewers regardless of whether the sewer is constructed of approved materials and has been successfully air tested.

Item G, subitem (5) is an exception that allows a 20-foot isolation distance to a buried sewer serving one building or two or less single family residences that is constructed of approved materials and is successfully tested.

Concrete or clay tile sewer pipes, and cast iron or plastic without sealed joints require a 50-foot isolation distance.

Sewers constructed of materials which do not meet the requirements of the Minnesota Plumbing Code, parts 4715.0530 and 4715.2820, must be a minimum of 50 feet from a water-supply well. The approved materials listed in the Minnesota Plumbing Code, part 4715.0530 and part 4725.4450, 1, G, (5), and the testing methods detailed in the Minnesota Plumbing Code, part 4715.2820 are summarized later. The complete text is included in the appendix.

*(13) a floor drain, grate, or trough connected to a buried sewer, except as provided in item G, subitem (5);*

The distance to a floor drain, grate or trough, is the same as the distance to the sewer it is connected to. If the sewer qualifies for the 20-foot setback, the grate also has a 20-foot setback. If the sewer has a 50-foot setback, so does the drain or grate.

A floor drain, grate or trough in a garage that is not directly receiving wastes, is not connected to a sewer or storm sewer, and discharges only to daylight does not have a setback.

*(14) a watertight sand filter, peat filter, or constructed wetland;*  
*(15) a storage area for bulk road deicing chemicals, except that the minimum distance to a sensitive water-supply well is increased to 100 feet as provided in subpart 2;*

Typically, these are state, county, or local government road salt storage areas.

*(16) the buried piping of a horizontal ground source closed loop heat exchanger except as provided in item H, subitem (2);*

The setback to the horizontal piping of a geothermal closed loop depends on the piping materials and fluid. If the fluid is food grade or USP grade propylene glycol the setback is 10 feet (item h, subitem 2). If the fluid is a more toxic chemical such as methanol or ethanol, the setback is 50 feet.

*(17) a sewage, septage, or sludge, land-spreading area, except that the minimum distance to a sensitive water-supply well is increased to 100 feet as provided in subpart 2;*

*(18) buried piping from petroleum, agricultural chemical, or hazardous material storage tanks;*

*(19) a disposal area for construction debris or demolition debris, except that the minimum distance to a sensitive water-supply well is increased to 100 feet as provided in subpart 2;*

*(20) a disposal area for household solid waste from a single residence, except that the minimum distance to a sensitive water-supply well is increased to 100 feet as provided in subpart 2;*

*(21) a solid waste transfer station, commercial compost site, or scrap yard;*

This includes above ground animal composting facilities.



*(22) a disposal area for water treatment backwash, except that the minimum distance to a sensitive water-supply well is increased to 100 feet as provided in subpart 2;*

This includes gravel pockets, drainfields, and surface disposal areas for backwash or discharge of water softeners, iron filters, reverse osmosis, or other water treatment devices.

*(23) an industrial cooling water pond, except that the minimum distance to a sensitive water-supply well is increased to 100 feet as provided in subpart 2;*

*(24) a gray-water dispersal area, except that the minimum distance to a sensitive water-supply well is increased to 100 feet as provided in subpart 2;*

Gray-water is sewage that does not contain toilet wastes. Gray-water is commonly wastewater from sinks, washing machines, baths, and showers. Gray-water will usually contain considerably fewer fecal organisms as compared to mixed sewage, but it is not pathogen free, and can contain cleaning products, solvents, pharmaceuticals, and other chemicals. As such, the isolation distance is 50 feet, the same as a sewage dispersal area.

A gray-water dispersal area includes a drainfield, trench, bed, gravel drain, pit, perforated tank, or other subsurface treatment/disposal system.

*(25) an anhydrous ammonia tank;*

*(26) an animal rendering plant;*

*(27) multiple tanks or containers of agricultural chemicals, hazardous materials, or hazardous wastes, for residential retail sale or use, each holding less than 56 gallons or 100 pounds dry weight, where the aggregate volume of the tanks and containers exceeds 56 gallons or 100 pounds dry weight;*

This requirement typically applies to farm and home, feed, hardware, paint, and other retailers that have many small containers of products such as weed killer or paint thinner.

*(28) a water treatment backwash holding basin, reclaim basin, or surge tank with a direct sewer connection;*

This typically is part of a municipal or commercial water treatment plant.

*(29) a storage area for oil-filled electrical transformers; and*

This does not include an electrical transformer in use on a utility pole.

*(30) an elevator boring except as provided in item G, subitem (12);*

An elevator boring meeting the requirements of the rules has a 20-foot setback while an (older) elevator boring not meeting the rules has a 50-foot setback.

*F. 35 feet from:*

*(1) vertical heat exchanger piping as specified in parts 4725.01000, subpart 49g, and 4725.7050, subpart 1, item G; and*

*(2) the ordinary high water level of a stream, river, pond, storm water retention pond, or lake as specified in part 4725.4350, subpart 1;*

The isolation distance to vertical heat exchanger piping (the vertical portion of the loop, not the horizontal “header”) and to a surface water body, such as a lake or stream, was reduced in 2008 from 50 feet to 35 feet.

*G. 20 feet from:*

*(1) a sewage sump with a capacity of less than 100 gallons which has been successfully tested in accordance with part 4715.2820, subpart 2 or 3, and is constructed according to part 4715.2440, subparts 1 and 4;*

The isolation distance to a sewage sump is 50 feet except a sump meeting the criteria of this rule may be as close as 20 feet. In order to qualify:

1. The sump tank, receptacle, or basket must have a total volume of less than 100 gallons;
2. The sump must be successfully tested after installation by either the 5 psi 15 minute air test, or the 1-inch water column manometer test. For safety reasons, most plumbers will use the manometer test (Minnesota Plumbing Code, part 4715.2820, subpart 3);
3. The sump must meet the Minnesota Plumbing Code construction standards (Minnesota Plumbing Code, part 4715.2440, subpart 1) including being constructed of poured concrete, metal, or other approved materials. Poured concrete tanks must be reinforced. Metal tanks must be treated inside and out to resist corrosion, and;
4. The sump must meet the Minnesota Plumbing Code cover standards (Minnesota Plumbing Code, part 4715.2440, subpart 2) including a gastight metal cover, except that float control or switch rods must operate without binding. The cover must be of a bolt and gasket type or equivalent manhole opening to permit access for inspection, repairs, and cleaning.

Part 4715.2440 is a portion of the Minnesota Plumbing Code. The text of the Minnesota Plumbing Code, part 4715.2440 which pertains to **sumps** can be found in the appendix.

*(2) a pit or unfilled space below the established ground surface that is four feet or more in depth, except a basement or building crawl space;*

This includes well pits, pits with pressure tanks, and root cellars or below-ground cribs not within a basement. Pits with contaminants, such as manure pits, have greater separation distances.

*(3) an in-ground swimming pool;*

There is no separation required from an above-ground swimming pool. An in-ground swimming pool must be 20 feet from a water-supply well.

*(4) a petroleum storage tank that is not buried, holding between 56 and 1,100 gallons;*

Fuel oil or other petroleum tanks of 1,100 gallons or less exposed above the floor of a basement are included in the 20-foot separation.

*(5) a buried sewer serving one building, or two or less single-family residences, constructed of cast-iron or plastic pipe according to the material specifications, methods, and testing protocol described in parts 4715.0530 and 4715.2820, subpart 2 or 3, or a floor drain connected to the buried sewer, except for:*

*(a) a collector or municipal sewer; or,*

*(b) a sewer serving a facility such as a hospital, nursing home, mortuary, veterinary clinic, health care clinic or similar facility handling infectious or pathological wastes;*

In order to maintain a 20-foot distance to a buried sewer, the sewer must be constructed of cast iron or plastic piping materials meeting the standards of the Minnesota Plumbing Code, Chapter 4715. The Minnesota Plumbing Code, part 4715.0530 specifies the approved materials (Note: The Minnesota Plumbing Code allows other materials such as concrete or clay tile. However, in order to qualify for the 20-foot distance, only the cast iron or plastic may be used). The Minnesota Plumbing Code, part 4715.2820 details the test requirements. The only type of sewer that may maintain the 20-foot distance is a building sewer (often referred to as the lateral or service line).

Well contractors are reminded to obtain **written certification of materials and pressure tests** before constructing water-supply wells less than 50 feet from buried sewers. In situations where wells are constructed less than 50 feet from buried sewers, the MDH Well Management Section may require documentation of sewer materials and verification of pressure tests. If this information cannot be provided, contractors will be held responsible for verification of materials, testing, or moving the sewer or well.

Use of approved materials and testing of buried sewers reduces the risk of well contamination; however, sewers may be ruptured during backfilling or crushed when driven over. Damage like this may go undetected and put nearby wells at risk of contamination. Whenever possible, a minimum setback distance of 50 feet (even if the sewer is constructed of approved materials and has been tested) between a well and a buried sewer is recommended.

The 20-foot distance does not apply to a sewer which serves as a collector or a municipal sewer.

## **APPROVED SEWER MATERIALS FOR THE 20-FOOT SETBACK**

The **approved materials in the Minnesota Plumbing Code**, that qualify for the 20-foot water-supply well setback in the well and boring rules include the following cast iron and plastic materials:

### Cast Iron

- ANSI A21.8, (extra heavy)
- ANSI A21.6, (centrifugally cast)
- CISPI 301-69T, (hubless)
- ANSI A21.11, A21.2, and A21.6, (gland type)
- ANSI A21.8, A21.4, A21.2, A21.6, A21.8, (gland type) cement lined

### Polyvinyl Chloride (PVC)

- ASTM D1785, Schedule 40, 14 to 24-inch only
- ASTM D2241, Schedule 40 and 80, SDR 21 and SDR 26 6-inch and larger
- ASTM D2665, Schedule 40, unthreaded
- ASTM D2949, Schedule 30, 3-inch
- ASTM D3034
- ASTM F 679, 18 to 27-inch only
- ASTM F789
- ASTM F794, 18-inch and larger
- ASTM F891, cellular core

### Acrylonitrile-Butadiene Styrene (ABS)

- ASTM D2661
- ASTM D2751
- ASTM F628 Type 1, Schedule 40, cellular core

It should be noted that High Density Polyethylene (HDPE), commonly used for onsite septic and collector sewer pressure piping is not an approved material in the Minnesota Plumbing Code. As such, a 50-foot isolation distance is required.

## **SEWER AND SUMP TESTING**

Three tests are used in order to reduce the setback between a sewer or sump and a water-supply well to 20 feet. The tests are the air test, hydrostatic test, and the manometer test.

The **air test** is conducted by plugging all inlets and outlets except for a single opening where air is forced into the system until there is a uniform pressure of 5 pounds per square inch. If the pressure remains constant for 15 minutes without the addition of air, the test is successful. The air test may be used on all sewer materials or on sumps. It should be noted that some municipalities, sanitary districts, or engineers use an air test established by the City Engineers Association of Minnesota which requires 4 psi pressure and allows leakage. This test is not equivalent to the Minnesota Plumbing Code test.

The **hydrostatic test** may only be done on thermoplastic sewer pipe which can be tested to 10 feet of water head. All openings of the pipes are plugged except the highest opening. The system is filled with water which will exert at least 10 feet of water head above the tested section. If the section holds water without leakage for 15 minutes, the section passes.

A **manometer test** is used for testing interior plumbing and sumps. It is not acceptable for building (exterior) sewers. It is conducted by plugging all vents, stacks, and building drains; filling all fixture traps with water; introducing air into the system equal to a 1-inch water column; and using a manometer, a “U” shaped tube. A drop in the column indicates an unsuccessful test.

The DLI requires that the tests be performed by:

- A Minnesota licensed plumber;
- A Minnesota licensed restricted plumber anywhere except a city of 5,000 population or more;
- A person with a pipe layer’s card for an outside sewer; or
- The property resident.

In order to meet the 20-foot setback the MDH requires that testing done by the resident must be witnessed by a local government official, MDH representative, or licensed plumber.

Unless it is documented that the sewer was constructed of approved materials and was tested, it is assumed that it was not. The MDH has developed a form that documents the names of the property owner and tester, which parts of the sewer system were successfully tested, and the types of sewer materials tested.

***(6) a storm water drain pipe eight inches or greater in diameter;***

A “**storm-water drain pipe**” is a pipe or conduit which conveys storm water (rain or snow melt) from streets, roofs, parking lots, or other surface sources. Storm water drain pipe does not include a pipe or conduit carrying;

- Domestic waste water, sewage, or industrial wastes;
- Clear water drainage from building perimeter drain tile; or
- Water from a floor drain not connected to a sewer, to a point of surface discharge.

If the pipe carries sewage, or sewage can back up into the pipe, the piping is considered a sewer, not a storm water drain pipe.

Clear water drainage from building perimeter drain tile or from a floor drain that daylights and is not connected to a sewer do not have a minimum setback.

Agricultural drainage pipes 8 inches or larger in diameter, connected to surface inlets are included in the 20-foot separation. Smaller diameter agricultural drain tile, or drain tiles not connected to a surface inlet are not included in the isolation requirement but are recommended to be a minimum of 20 feet from a well.

***(7) an animal building, feedlot, confinement area, or kennel holding 0.1 to 1.0 animal unit, except that the minimum distance to a sensitive water-supply well is increased to 40 feet as provided in subpart 2;***

This setback applies to animal confinement areas holding from 100 to 1,000 pounds of animals. Kennels, hobby farms, and animal care and boarding facilities would commonly fit in this category.

***(8) a buried non-pressurized water supply cistern or reservoir;***

*(9) a gravel pocket or French drain for clear water drainage;*

Clear water drainage is potable water discharge from a hydrant, faucet, or pump; or rainfall infiltrating a perimeter drain tile system that does not contain runoff. Clear water drainage does **not** include water treatment backwash, piped storm water, gray-water, or condensate drainage from a furnace, air conditioner, chiller or other mechanical device.

*(10) a portable privy or toilet;*

*(11) a water treatment backwash holding basin, reclaim basin, or surge tank, and associated piping, with a backflow protected sewer connection; and*

*(12) an elevator boring conforming to part 4725.7250; and*

This is an elevator boring conforming to the construction rules. The detailed elevator rules were first in effect in May 1993.

*H. ten feet from:*

*(1) a frost-proof yard hydrant or discharge of a frost proof hydrant draining into the soil, a fire hydrant, or a flushing hydrant; and*

A 10-foot distance is required from a frost-proof yard hydrant because of the drain-back feature.

A 10-foot distance is not required between a well and a faucet or hydrant **without** a drain-back. However, a 10-foot distance is recommended.

Minnesota Rules, Chapter 4725, do not have specific installation or construction requirements for frost-proof hydrants as of the date of this handbook edition except the setback to water-supply well. However, the Minnesota Plumbing Code only allows a drain-back hydrant if the installation is approved by the administrative authority (DLI or local government), the hydrant is installed at least 2 feet above the water table, and the hydrant is located at least 10 feet from any sewer.

*(2) the horizontal piping of a vertical heat exchanger, or a horizontal ground source closed loop heat exchanger constructed of materials, and using a heat transfer fluid, according to part 4725.7050.*

The setback to horizontal piping, whether for a vertical heat exchanger, or a horizontal, slinky, or pond geothermal system is 10 feet if the piping meets the materials standards of this chapter and contains food grade or USP grade propylene glycol.

## **COMMUNITY PUBLIC-SUPPLY WELLS**

Additional isolation distance requirements for community public water-supply wells are found in Minnesota Rules, part 4725.5850, subpart 2.

## ISOLATION NOT REQUIRED

A SETBACK OR ISOLATION IS **NOT** REQUIRED BETWEEN A WATER-SUPPLY WELL AND:

- Another water-supply well which meets the standards of these rules;
- A clear water (clear water does not include water softener discharge, furnace condensate, chiller or boiler drainage, or water from other mechanical sources) drain, clear water sump, or footing drain that is not connected to the sewage system;
- A garage floor drain that is not connected to other pipes and goes to daylight;
- An above-ground swimming pool;
- A quarry or gravel pit (the isolation distances to a water body or contamination sources such as gasoline tanks, do apply);
- Grain or silage silo (however, a setback is recommended, and a setback of 50 feet is required from a silage leachate pond or lagoon);
- Accumulations of clean fill, sand, or tree wastes (leaves, wood);
- A floor drain in a sauna that is not connected to other fixtures, drains, or plumbing and that daylights;
- A hydrant or faucet that does not have an underground drain-back;
- A storage area for water treatment chemicals such as chlorine;
- A property line; or
- A railroad track.

## CONTAMINATION SOURCES WHICH HAVE BEEN REMOVED

Contamination sources which have been removed, or no longer constitute a threat to water quality, do not require a separation distance. A nonleaking sewer that is plugged and disconnected or removed, or a nonleaking septic tank or holding tank that is pumped and disconnected or excavated and removed, is not required to be separated from a water-supply well. Separation is recommended if possible. However, drainfields, animal feedlots, cesspools and other contamination sources where contaminants still exist in the soil must maintain the separation distance unless the contamination is removed or a variance granted. The MDH Well Management Section should be contacted prior to removal of a contamination source in order to place a well less than the minimum isolation distance.

*Subp. 2. Increased isolation distances for sensitive water-supply wells. The distances in items A to F are exceptions to the isolation distances in subpart 1. The isolation distances in subpart 1 are doubled between a sensitive water-supply well and a contamination source directly entering the soil. A sensitive water-supply well must be located at least:*

A sensitive water-supply well has less than 50 feet of watertight casing and does not penetrate a 10-foot confining layer or 10 feet of confining materials. A confining layer or confining materials most commonly consist of clay, sandy clay or silty clay. The definitions in Minnesota Rules, part 4725.0100 provide additional information.

This requirement is often referred to as the requirement to double the distances for **shallow wells**. This is only partly correct. The distances are doubled only where the contaminants are actually entering the soil; however, the distances to other (nonleaking) sources are not doubled. The requirement most often applies to shallow wells, usually sand points; but it also applies to rock wells that may be hundreds of feet deep but have less than 50 feet of casing, dug wells that are not grouted to a depth of 50 feet or grouted through 10 feet of a confining layer, or wells deeper than 50 feet where the screen is within 50 feet of the surface.

Another misconception is that this rule essentially prohibits a water-supply well less than 50 feet deep. If the well is properly located and meets all other requirements of the rules, a potable water-supply well may be as shallow as 15 feet deep.

*A. 600 feet from the absorption area of a soil dispersal system with an average design flow greater than 10,000 gallons per day, a landfill or dump containing mixed municipal solid waste from multiple persons, a permitted demolition debris landfill, a municipal or industrial wastewater rapid infiltration basin, a municipal wastewater stabilization pond with 500 or more gallons/acre/day leakage, or a liquid manure storage basin or lagoon that is unpermitted or noncertified according to chapter 7020;*

*B. 300 feet from the absorption area of a soil dispersal system serving a facility such as a hospital, nursing home, mortuary, veterinary clinic, health care clinic or similar facility handling infectious or pathological wastes; a municipal wastewater stabilization pond with less than 500 gallons/acre/day leakage; an industrial wastewater stabilization pond; a municipal or industrial wastewater spray irrigation area; or a liquid manure storage basin or lagoon that does not have a concrete or composite liner, but has an earthen liner that was constructed under a Minnesota Pollution Control Agency permit or is certified according to chapter 7020;*

*C. 200 feet from a manure storage area, a liquid manure storage basin or lagoon with a concrete or composite liner according to chapter 7020, or an unroofed animal feedlot holding 300 or more animal units;*

*D. 150 feet from a cesspool, seepage pit, leaching pit, or dry well;*

*E. 100 feet from an animal feedlot holding more than one animal unit except as provided in item C; an animal or poultry feeding or watering area within a pasture holding more than one animal unit; an animal or poultry building including a horse riding arena holding more than one animal unit; the absorption area of a soil dispersal system; a privy; a storage area for road deicing chemicals; a sewage, septage, sludge, or waste landspreading area; a disposal area for construction or demolition debris; a disposal area for household solid waste from a single residence; a disposal area for water treatment backwash; an industrial cooling water pond; a gray-water dispersal area; or similar contamination source; and*

*F. 40 feet from an animal building, feedlot, confinement area, or kennel holding 0.1 to 1.0 animal unit.*

Items A through F above tabulate the doubled setbacks between sensitive wells and contaminants entering the soil.



Isolation distances are doubled between a sensitive water-supply well and a contamination source directly entering the soil.

- A “sensitive” water-supply well has less than 50 ft. of watertight casing where the casing does not penetrate a confining layer or multiple layers of confining materials with an aggregate thickness of 10 ft. or more.
- Examples of such contaminant sources include: manure storage area or basin, cesspool, seepage pit, drainfield, animal building, feedlot, privy and similar contaminant sources.

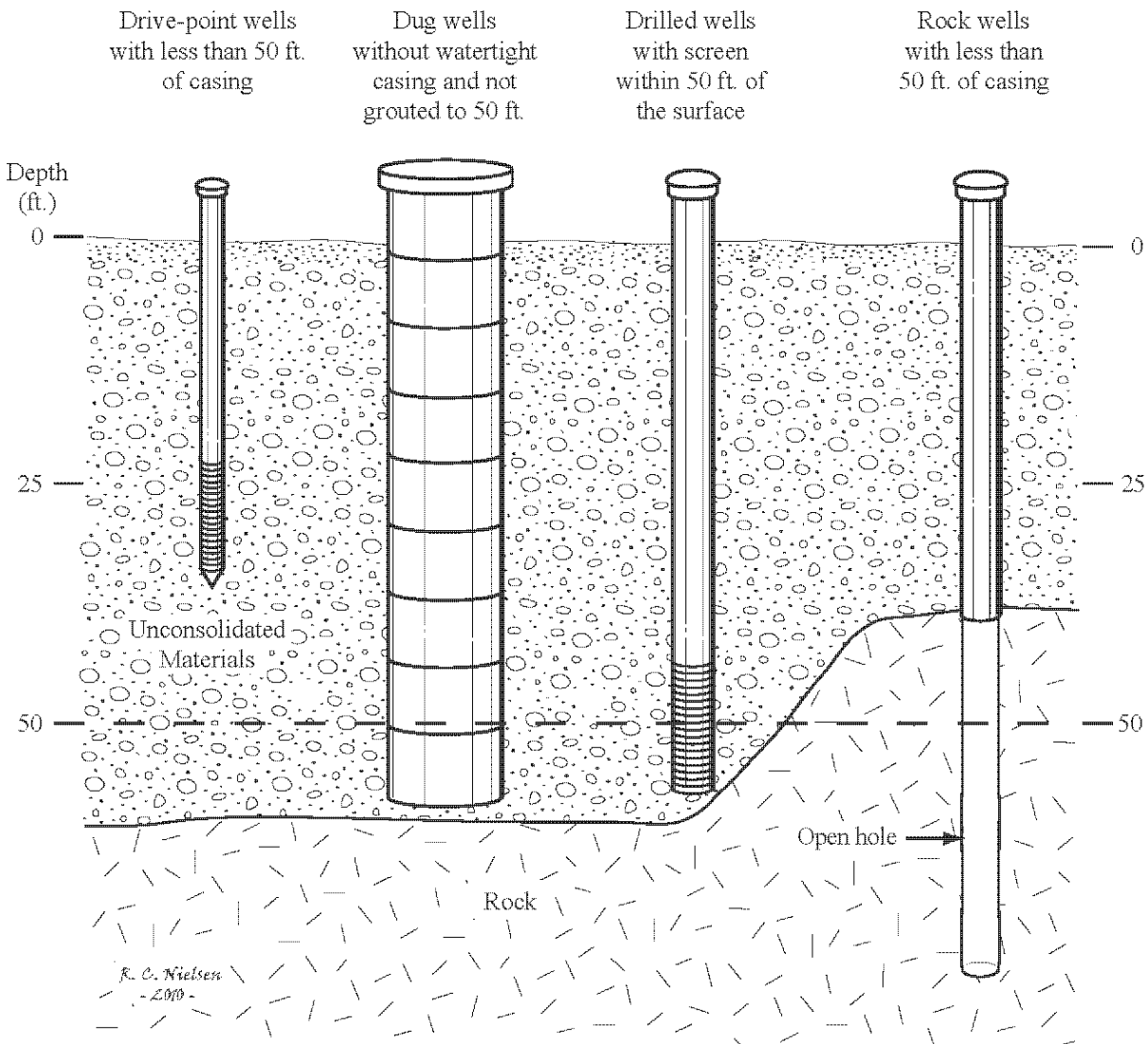

Figure 26. Examples of Wells That Require Doubling of the Isolation Distances From Contaminants Entering the Soil

***Subp. 3. Exception for irrigation well and fertilizer chemigation tank. An irrigation well used only for non-potable purposes must be at least 20 feet from a fertilizer chemigation supply tank conforming to the applicable requirements, setbacks, safeguarding, antipollution devices, purging, and posting requirements of parts 1505.2100 to 1505.2800.***

An **irrigation well** (no other type of well) may be **20 feet** from an **agricultural fertilizer chemigation supply tank** (not an herbicide or other pesticide tank) only if the fertilizer chemigation system is protected with safeguards meeting the MDA chemigation requirements. The MDA rules in Minnesota Rules, part 1505.2300, require safeguarding if two of the three conditions are met:

1. The supply tank has a rated capacity of more than 1,500 United States gallons;
2. The supply tank is located within 100 feet of a water supply; or
3. The supply tank is located at a chemigation site for more than 30 consecutive days.

This means that the small, temporary, fertilizer chemigation tanks do not require secondary containment, but must meet the other MDA requirements such as an injection pump interlock and backflow protection.

The safeguards protect the well, but are physically part of the chemical storage, pumping, and injection system.

Minnesota Rules, part 1505.2300, subpart 2, items D and E (MDA chemigation rules) are summarized below and are printed in the appendix.

- The capacity of the safeguard for an agricultural chemical supply tank must be at least equal to the sum of all of the following:
  - The volume of the largest container within the safeguard;
  - 25 percent of the capacity of the largest container within the safeguard for an unroofed safeguard, or 10 percent of the capacity of the largest container within the safeguard covered with a roof; and
  - The total volume of released liquid that would be displaced by all other containers within the safeguard.
- The walls and base of a safeguard may be made of ferrous metal, reinforced concrete, solid masonry, synthetic lined earth, or prefabricated ferrous metal or synthetic materials. The safeguard must be designed according to standard engineering practices to be leak proof and to withstand a full hydrostatic head of released liquid to the height of the safeguard.
- Masonry walls must be reinforced, capped with concrete, and purged on the interior. Joints and seams must be leak proof. The interior base and walls must be coated with a material resistant to agricultural chemicals.
- The joints between a reinforced concrete wall and any floor or liner must use internal waterstops or similar materials to make the joint leak proof. Control joints protected with waterstops or similar materials must be used for the base. The interior base and walls must be coated with a material resistant to agricultural chemicals. Cracks and seams must be sealed.
- Synthetic liners must have a minimum thickness of 30 mils (0.8 millimeters), be chemically compatible with the materials being stored within the safeguard, photo resistant, and puncture resistant.
- A prefabricated safeguard must be composed of rigid walls and a base of ferrous metal or synthetic materials that are resistant to corrosion, puncture, or cracking. Materials used for the safeguard must be chemically compatible with the materials being stored within the safeguard. Synthetic materials must be photo and puncture resistant.
- The base and walls of a safeguard may not contain a drain or similar opening.

*STAT AUTH: MS s 103I.101; 103I.111; 103I.205; 103I.221; 103I.301; 103I.401; 103I.451; 103I.501; 103I.525; 103I.531; 103I.535; 103I.541; 103I.621; 144.05; 144.12; 144.383; 157.04; 157.08; 157.09; 157.13*

*HIST: 17 SR 2773; 18 SR 1222; 33 SR 211*

**4725.4500** [*Repealed, 17 SR 2773*]



## Isolation Distances From A Water-Supply Well

Minnesota Rules, Chapter 4725  
 Rules Relating to Wells and Borings  
 August 4, 2008

Minnesota Department of Health

Well Management Section  
 625 North Robert Street, P.O. Box 64975  
 St. Paul, Minnesota 55164-0975  
 651-201-4600 or 800-383-9808  
[www.health.state.mn.us/divs/eh/wells](http://www.health.state.mn.us/divs/eh/wells)

Environmental Health Division

This list of isolation distances is summarized from Minnesota Rules, Chapter 4725. These distances are to be measured horizontally from the water-supply well. Minnesota Statutes, section 103I.205, subdivision 6, prohibits constructing, placing, or installing an actual or potential contaminant source at a location from a well that is less than the minimum distance prescribed by rule. The minimum isolation distances must be maintained between a new well and a source of contamination no longer in use, unless all contaminants have been removed from the source, and visibly contaminated soils have been removed. For complete regulations, consult these rules and Minnesota Statutes, Chapter 103I. Additional information and explanation can be obtained by consulting the *Rules Handbook, A Guide to the Rules Relating to Wells and Borings*, or by contacting the Well Management Section, Minnesota Department of Health (MDH).

Absorption area of a soil dispersal system	
average flow greater than 10,000 gallons/day .....	300 feet <sup>1</sup>
serving a facility handling infectious or pathological wastes .....	150 feet <sup>1</sup>
average flow 10,000 gallons/day or less.....	50 feet <sup>1</sup>
Agricultural chemical	
tank or container with 25 gallons or more or 100 pounds or more dry weight, or equipment filling or cleaning area without safeguards.....	150 feet
storage or equipment filling or cleaning area with safeguards .....	100 feet
storage or equipment filling or cleaning area with safeguards and roofed.....	50 feet
buried piping.....	50 feet
multiple tanks or containers for residential retail sale or use, no single tank or container exceeding, but aggregate volume exceeding 56 gallons or 100 pounds dry weight.....	50 feet
Anhydrous ammonia tank.....	50 feet
Animal	
feedlot, unroofed, 300 or more animal units .....	100 feet <sup>1</sup>
feedlot, more than 1.0, but less than 300 animal units .....	50 feet <sup>1</sup>
building or poultry building, including a horse riding area, more than 1.0 animal unit.....	50 feet <sup>1</sup>
rendering plant.....	50 feet
feeding or watering area within a pasture, more than 1.0 animal unit.....	50 feet <sup>1</sup>
area to bury more than one animal unit .....	50 feet
building, feedlot, confinement area, or kennel, 0.1 to 1.0 animal unit.....	20 feet <sup>1,2</sup>
Building, building projection, deck, overhang, permanent structure.....	3 feet <sup>3</sup>

Cesspool .....	75 feet <sup>1</sup>
Cistern or reservoir, buried, nonpressurized water supply .....	20 feet
Commercial compost site .....	50 feet
Construction or demolition debris disposal area .....	50 feet <sup>1</sup>
Cooling water pond, industrial .....	50 feet <sup>1</sup>
Deicing chemicals, bulk road .....	50 feet <sup>1</sup>
Dry well (sewage).....	75 feet <sup>1</sup>
Electric transmission line .....	10 feet <sup>4</sup>
Electrical transformer storage area, oil-filled.....	50 feet
Elevator boring, not conforming to rule .....	50 feet
conforming to rule .....	20 feet
Fertilizer chemigation tank, safeguarded, from irrigation well only .....	20 feet <sup>5</sup>
Floor drain, grate, or trough	
connected to a buried sewer.....	50 feet
if buried sewer is air-tested, approved materials, serving one building, or	
two or less single-family residences .....	20 feet <sup>2</sup>
Frost-proof yard hydrant or discharge of a frost-proof hydrant draining into the soil,	
fire hydrant or flushing hydrant.....	10 feet
Gas (flammable or volatile) pipe.....	10 feet <sup>4</sup>
Grave or mausoleum.....	50 feet
Gravel pocket or French drain for clear water drainage .....	20 feet
Gray-water dispersal area.....	50 feet <sup>1</sup>
Hazardous substance	
tank or container, above ground or underground, 56 gallons or more, or 100 pounds	
or more dry weight, without safeguards .....	150 feet
tank or container, above ground or underground, 56 gallons or more, or 100 pounds	
or more dry weight with safeguards .....	100 feet
buried piping.....	50 feet
multiple storage tanks or containers for residential retail sale or use, no single tank or	
container exceeding 56 gallons or 100 pounds, but aggregate volume exceeding .....	50 feet
Horizontal ground source closed loop heat exchanger buried piping.....	50 feet
Horizontal ground source closed loop heat exchanger buried piping and horizontal piping,	
approved materials and heat transfer fluid.....	10 feet <sup>2</sup>
Household solid waste disposal area, single residence.....	50 feet <sup>1</sup>
Interceptor, including a flammable waste or sediment.....	50 feet
Land spreading area for sewage, septage, or sludge.....	50 feet <sup>1</sup>
Landfill or dump, mixed municipal solid waste from multiple persons.....	300 feet <sup>1</sup>
Landfill, permitted demolition debris.....	300 feet <sup>1</sup>
Leaching pit.....	75 feet <sup>1</sup>
Liquid propane (LP) tank .....	10 feet <sup>4</sup>

Manure (liquid) storage basin or lagoon	
unpermitted or noncertified .....	300 feet <sup>1</sup>
approved earthen liner .....	150 feet <sup>1</sup>
approved concrete or composite liner.....	100 feet <sup>1</sup>
Manure (solid) storage area, not covered with a roof.....	100 feet <sup>1</sup>
Ordinary high water level of a stream, river, pond, storm water retention pond, lake, or reservoir.....	35 feet <sup>2</sup>
Petroleum	
tank or container, 1100 gallons or more, without safeguards.....	150 feet
tank or container, 1100 gallons or more, with safeguards.....	100 feet
tank or container, buried, between 56 and 1100 gallons .....	50 feet
tank or container, not buried, between 56 and 1100 gallons .....	20 feet <sup>6</sup>
buried piping.....	50 feet
Petroleum or crude oil pipeline to a refinery or distribution center .....	100 feet
Pit or unfilled space more than four feet in depth .....	20 feet
Pollutant or contaminant that may drain into the soil.....	50 feet <sup>1</sup>
Privy, nonportable .....	50 feet <sup>1</sup>
portable (privy) or toilet .....	20 feet <sup>2</sup>
Sand filter, watertight; peat filter; or constructed wetland .....	50 feet
Scrap yard.....	50 feet
Seepage pit .....	75 feet <sup>1</sup>
Septic tank .....	50 feet
Sewage holding tank, watertight .....	50 feet
Sewage sump	
capacity 100 gallons or more.....	50 feet
capacity less than 100 gallons, tested, conforming to rule .....	20 feet <sup>2</sup>
Sewage treatment device, watertight .....	50 feet
Sewer, buried	
collector, municipal, serving a facility handling infectious or pathological wastes, open-jointed or unapproved materials .....	50 feet
approved materials, tested, serving one building, or two or less single-family residences .....	20 feet <sup>2</sup>
Solid waste transfer station.....	50 feet
Storm water drain pipe, 8 inches or greater in diameter.....	20 feet <sup>2</sup>
Swimming pool, in-ground.....	20 feet
Unused, unsealed well or boring .....	50 feet
Vertical heat exchanger (vertical) piping, conforming to rule .....	35 feet <sup>2</sup>
horizontal piping conforming to rule.....	10 feet <sup>2</sup>
Wastewater rapid infiltration basin, municipal or industrial .....	300 feet <sup>1</sup>
Wastewater spray irrigation area, municipal or industrial.....	150 feet <sup>1</sup>
Wastewater stabilization pond	
municipal, 500 or more gallons/acre/day of leakage .....	300 feet <sup>1</sup>
municipal, less than 500 gallons/acre/day of leakage.....	150 feet <sup>1</sup>
industrial .....	150 feet <sup>1</sup>
Wastewater treatment unit tanks, vessels and components (Package plant) .....	100 feet
Water treatment backwash disposal area.....	50 feet <sup>1</sup>

Water treatment backwash holding basin, reclaim basin, or surge tank	
with a direct sewer connection .....	50 feet
with a backflow protected sewer connection.....	20 feet

**Additional Isolation Distances For  
Community Public Water-Supply Wells**

Highest water or flood level .....	50 feet
Property line, unless legally controlled through an easement .....	50 feet

<sup>1</sup> A sensitive water-supply well must be located at least twice the indicated distance.

A sensitive water-supply well is a well with less than 50 feet of watertight casing, and which is not cased below a confining layer or confining materials of at least 10 feet in thickness.

<sup>2</sup> A community public water-supply well must be a minimum of 50 feet from this contamination source.

<sup>3</sup> A well or boring may not be constructed inside a building except as provided for by Minnesota Rules, part 4725.2175.

<sup>4</sup> A well or boring may be located between 5 and 10 feet of an electric transmission line, gas pipe or LP tank if the well or boring is placarded, and work is not performed on the well or boring unless the electric line is deenergized and grounded or shielded, and the LP tank does not contain flammable gas.

<sup>5</sup> The 20-foot distance applies only to an irrigation well and a fertilizer chemigation supply tank meeting the requirements of Minnesota Rules, Chapter 1505.

<sup>6</sup> A community public water-supply well must be a minimum of 50 feet from a petroleum tank or container, unless the tank or container is used for emergency pumping and is located in a room or building separate from the community well; and is of double-wall construction with leak detection between walls; or is protected with secondary containment.

Visit the MDH Well Management Section Web site at: [www.health.state.mn.us/divs/eh/wells](http://www.health.state.mn.us/divs/eh/wells).

Visit Minnesota Rules, Chapter 4725 Web site at: [www.revisor.mn.gov/rules/?id=4725](http://www.revisor.mn.gov/rules/?id=4725).

Visit Minnesota Statutes, Chapter 103I Web site at: [www.revisor.mn.gov/statutes/?id=103I](http://www.revisor.mn.gov/statutes/?id=103I).

To request this document in another format call 651-201-4600. Deaf and hard-of-hearing: TTY 651-201-5797.

origs\isolate.doc 09/15/2010R

#### **4725.4550 MINIMUM PROTECTIVE DEPTH.**

*A potable water-supply well must be cased to a depth of at least 15 feet from the established ground surface. The top of a gravel pack must terminate at least 15 feet below the established ground surface.*

This applies to **water-supply wells used to provide water for human consumption, food or medicinal preparation, or that are connected to plumbing fixtures** such as sinks or faucets accessible for consumption. This rule part requires a minimum of 15 feet of watertight casing not including the casing above ground or the screen.

The 15-foot minimum casing does not apply to borings or nonpotable wells such as dewatering wells, monitoring wells, remedial wells, or irrigation wells.

“**Established ground surface**” is defined in these rules to mean the intended or actual finished grade (elevation) of the surface of the ground at the site of a well or boring. This includes built up grades with pavers, brick, stone, landscape rock, concrete or other materials.

*STAT AUTH: MS s 103I.101; 103I.221; 103I.301; 103I.621; 144.05; 144.12; 144.383; 157.04; 157.08; 157.09; 157.13*  
*HIST: 17 SR 2773; 33 SR 211*

#### **4725.4600 [Repealed, 17 SR 2773]**

#### **4725.4650 SEDIMENT IN POTABLE WATER-SUPPLY WELLS.**

*The following requirements apply to a new potable water-supply well.*

This applies to new water-supply wells used to provide water for human consumption, food or medicinal preparation, or that are connected to plumbing fixtures such as sinks or faucets accessible for consumption. The requirement does not apply to existing wells which are rescreened, redrilled or redeveloped. The requirement does not apply to irrigation, remedial, or other types of wells.

*A. A water-supply well must be developed to remove drilling fluid, native silts and clays deposited during drilling, and the predetermined finer fraction of the natural formation or the gravel pack.*

Development is the process of agitating the formation to remove drilling fluids, sediment in the screen or bore hole, loose sediment in the formation, and fine formation material that can pass through the screen or gravel pack. The object in a screened well is to remove the fines near the bore hole to grade the formation particles from larger to smaller away from the screen.

Development techniques include over-pumping, surging with a bailer or surge block, air lift pumping, jetting, use of compressed gasses or dry ice, use of sonic tools, and explosives. Hydrofracturing may be considered a development tool in some cases. The most common technique is over-pumping, which while being simple and possibly inexpensive, is one of the least effective techniques. Over-pumping with the well pump can lead to damage of the pump. Jetting while airlift pumping is one of the better techniques.



*B. A new water-supply well must not produce a sustained quantity of more than five milligrams per liter (mg/l) of sand, or more than 200 mg/l of silt and clay as defined in part 4725.1851, subpart 4, item A for potable water at the design capacity of the well, except when geological conditions preclude meeting the standard, and the well owner, licensee, and commissioner agree to accept the sediment in a stipulated agreement.*

The rule is based on a sustained yield of sand, not a momentary excess due to a pump start or flushing of settled sand in the water system. The rule is also based on the design capacity of the original pump. Installation of a larger pump would make this requirement not applicable.

Sediment can rapidly damage pumps, piping, fittings, screens, equipment, and fixtures such as dishwashers and washing machines. In excessive amounts, sediment can cause erosion of the annular seal, subsidence and collapse. Sediment can provide locations for organisms to grow and make disinfection very difficult. Where possible, it is recommended that all wells, not just potable water-supply wells, produce less than 5 mg/L of sand and less than 200 mg/L of silt and clay.

The standards are based on weight per volume; 5 milligrams of sand or 200 mg/L of silt and clay in 1 liter (approximately 1 quart) of water. The amount of sand can be accurately determined by measuring the weight of sand in a known volume of water. A Rossum sand tester or Imhoff cone can be used to determine sand content. A rough **estimate** of the sand content can be made by collecting a liter sample of water, allowing the sand to settle to the bottom of the container, and counting the number of sand grains. Typically, 5 mg/L of sand will equal 10 to 40 sand grains, depending on the grain size and mineral type. Another **estimate** can be obtained by collecting 20 gallons of water. Five mg/L of sand is approximately equal to a circle of sand the size of a dime in 20 gallons of water.

Two hundred milligrams per liter of silt or clay is more difficult to visually estimate without laboratory analysis, because of the variation in material and grain size. However, 200 mg/L of silt, when completely settled, is roughly equal to a circle of sediment the size of a nickel in 1 liter of water. When shaken, 200 mg/L of silt and clay in one liter of water appears visibly cloudy, so much so that most persons will not drink water with 200 mg/L of sediment.

Certain geologic conditions such as some flowing well areas, finely laminated sediments, or weathered interbeds of clay may not supply acceptable quantities of water and still meet the sediment standards. In such cases, a stipulated agreement between the well owner, licensee, and the commissioner may be acceptable.

*STAT AUTH: MS s 103I.101; 103I.111; 103I.205; 103I.221; 103I.301; 103I.401; 103I.451; 103I.501; 103I.525; 103I.531; 103I.535; 103I.541; 103I.621; 144.05; 144.12; 144.383; 157.04; 157.08; 157.09; 157.13*  
*HIST: 17 SR 2773; 33 SR 211*

*4725.4700 [Repealed, 17 SR 2773]*

#### **4725.4750 LEAD PROHIBITION IN POTABLE WATER-SUPPLY WELLS.**

*Materials used in construction of a potable water-supply well that contact water must not exceed eight percent lead except that solders and flux must not contain more than 0.2 percent lead.*

**Lead packers** can no longer be used to connect or seal screens to a casing. Alternative devices such as neoprene rubber k-packers are available for this purpose.

Particular attention should be paid to red brass fittings, which commonly contain more lead than yellow brass and may exceed the 8 percent standard. Lead-free brass compounds, such as silicon brass, are becoming increasingly available.

*STAT AUTH: MS s 103I.101; 103I.111; 103I.205; 103I.221; 103I.301; 103I.401; 103I.451; 103I.501; 103I.525; 103I.531; 103I.535; 103I.541; 103I.621; 144.05; 144.12; 144.383; 157.04; 157.08; 157.09; 157.13*

*HIST: 17 SR 2773; 33 SR 211*

#### **4725.4800 [Repealed, 17 SR 2773]**

#### **4725.4825 NONPOTABLE WATER-SUPPLY WELLS.**

*Subpart 1. **Construction.** A water-supply well used to provide water for nonpotable purposes such as irrigation, heating and cooling, or industrial processing, that is not used for purposes listed in part 4725.0100, subpart 35a, must be constructed according to parts 4725.2010 to 4725.5550, except parts 4725.4550, 4725.4650, and 4725.4750.*

Nonpotable water-supply wells (such as irrigation or industrial process waters) must be constructed to the general wells and borings standards and the water-supply well standards, except that the 15-foot minimum casing requirement of Minnesota Rules, part 4725.4550, the development and sediment standards of Minnesota Rules, part 4725.4650, and the lead standard of Minnesota Rules, part 4725.4750 do not apply.

*Subp. 2. **Interconnection prohibited.** A nonpotable well or water system must not be interconnected with a potable well or water system except as provided in part 4725.3350.*

Minnesota Rules, part 4725.3350 requires backflow prevention according to the Minnesota Plumbing Code.

***Subp. 3. Identification required. A nonpotable well water system providing water to a building with a potable water system, or accessible to the public, must be marked as nonpotable according to part 4715.1910.***

The Minnesota Plumbing Code, part 4715.1910, requires that in a building which has both potable and nonpotable water systems, both systems must be marked. The Minnesota Plumbing Code identifies two types of markings; color and metal tags. Color markings require potable pipes to be marked green and nonpotable to be marked yellow. The entire pipe can be marked, or 3-inch wide color bands placed at 25-foot intervals and where pipes pass through walls, roofs, or floors. Metal tags must be 3-inch diameter round tags bearing the legend "safe water" for potable piping, and 4-inch equilateral triangles bearing the legend "nonpotable water." The tags must be placed at 25-foot intervals, and where the pipe passes through a wall, roof, or floor.

***STAT AUTH: MS s 103I.101; 103I.111; 103I.205; 103I.221; 103I.301; 103I.401; 103I.451; 103I.501; 103I.525; 103I.531; 103I.535; 103I.541; 103I.621;***

***HIST: 33 SR 211***

**4725.4850 WATER-SUPPLY WELL PITLESS ADAPTER OR PITLESS UNIT, AND WELDED OR THREADED FITTING.**

*Subpart 1. Pitless adapter or pitless unit. Except as provided in subpart 2, a connection to a casing of a water-supply well made less than 12 inches above the established ground surface must be made with a pitless adapter or pitless unit. The connection must not be submerged in water at the time of installation. Native materials must be packed tightly around the pitless adapter or pitless unit to the ground surface. The pitless adapter or pitless unit must:*

*A. be constructed to provide complete clearance within the internal diameter of the casing;*

*B. be designed to be field-welded by holding the welding rod in a vertical or horizontal position, or bench-welded before field installation with a material as corrosion-resistant as the parent material;*

*C. have all threaded joints watertight with no threads exposed;*

*D. impart no taste, odor, or toxic material to the water; and*

*E. connect to the casing by a threaded connection, welded connection, bolted flange with gasket, clamp and gasket, or compression gasket.*

*A welded, solvent welded, or threaded coupling, adapter, or swaged fitting meeting the material standards of part 4725.2350, 4725.2550, or 4725.6650, may be used to connect a casing to a pitless adapter or unit.*

*Additionally, a pitless unit using a compression seal must provide for the well casing to extend at least 2.5 inches into the throat of the pitless unit. The compression collar must be held in place with corrosion-resistant bolts, nuts, and washers. The installer of a clamp-on or weld-on pitless adapter must use a guide or template for cutting the hole in the casing to accommodate the pitless adapter.*

Pitless adapters and units are fittings attached to or replacing the casing, usually below the frost line, that allow a water discharge line to exit the casing below frost and not freeze, allow the pump to be removed without excavation, and allow the casing to be extended above grade for proper venting, service, and sanitary protection. A pitless adapter is a fitting inserted into a hole in the side of the casing. A pitless unit is a fitting and upper casing that replaces the casing from the frost line to above the surface. Pitless adapters and units are so named because they replace the old, unsafe, and unsanitary practice of putting wells in pits.

Water discharge connections to a water-supply well casing made lower than 12 inches above-grade (even if the connection is above-ground) must be made with an approved pitless. A connection for venting or remediation (remedial well), water level measurement, treatment, or electrical may be made with a fitting as described in subpart 2 below.

Water-supply well connections made higher than 12 inches above-grade must be made with a threaded connection, welded connection, rubber expansion sealer, or a bolted flange as detailed in Minnesota Rules, part 4725.3150. The top of the casing must be covered with a well cap, cover, or pump base as detailed in Minnesota Rules, part 4725.4950.

The **casing extension**, from the pitless adapter above-ground, must be made of material which meets the casing standards as detailed in Minnesota Rules, parts 4725.2250 through 4725.2550. The casing extension for factory-made pitless units including the spool, adapter, discharge and upper casing extension may be of materials not meeting the casing standards of Minnesota Rules, parts 4725.2250 through 4725.2550 if the entire unit has been approved by the MDH as an engineered unit.

The water may be pumped down so that the connection is not submerged in water during installation.

This requires a “**clear-way**”-type pitless. The clear-way requirement applies to all casing sizes, and to open hole wells as well as screened wells. “Clear-way” means that when the pull pipe, internal drop pipe fitting assembly, actuator, discharge elbow, spool, drop pipe, and pump are removed; no portion of the pitless extends inside the inner wall of the casing. This allows for removal or installation of a full-sized screen or pump, and allows full casing access for rehabilitation or repair.

A pitless unit must be at least as large as the casing, and may be larger. A 4-inch pitless may not be placed on a 6-inch casing. However, a 6-inch pitless may be placed on a 4-inch casing.

The rules require that no casing threads be exposed on threaded pitless units. Many of the pitless units currently available have threads exposed when the pitless is threaded onto the casing and upper casing extension. The use of pitless units with “buried” threads is encouraged. However, the department will allow pitless units with exposed threads to be used if the units otherwise meet the standards of these rules and if all exposed threads are corrosion protected by use of a protective coating. The protective coating must be designed to provide corrosion protection for buried steel, and does not include tape or other wrapping products.

It is recommended that all water contact components meet ANSI/NSF Standard 61.

This allows pitless units (or adapters) which are threaded onto the casing, welded to the casing, bolted with a gasket, clamped with a gasket (“clamp-on” type), or compression fittings (“Dresser” type or “Kwick-connect” type).

The guide is required for holes cut with a torch, reciprocating saw, or method other than a hole saw. The guide must be followed to cut the correct size hole. Slag, burrs, or rough edges on surfaces which contact a gasket or “O”-ring must be smoothed. The correct size hole saw must be used in order to prevent leaks. A leak at the pitless is a common cause of bacterial contamination of the well. Leaks may occur from a cross threaded casing or discharge line; undertightened, over-tightened, or broken clamp; irregular shaped hole; missing or defective gasket; separation due to frost; and damage from vehicles.

A list of pitless adapters and units which currently meet the standards is included in the appendix. The list only includes approved models commonly available, and does not include models out of production which still may be in stock. Models not on the list may be used if they meet the requirements in these rules. The MDH may be contacted to review additional models.

*Subp. 2. **Welded or threaded fitting.** A welded or threaded fitting meeting the requirements of part 4725.3150, subpart 2, may be connected to the side, cap, or cover, of a water-supply well casing and be used for venting, remediation, measurement of water levels or testing, treatment, or for an electrical connection. A water discharge line must be connected with a pitless unit or pitless adapter.*

*STAT AUTH: MS s 103I.101; 103I.111; 103I.205; 103I.221; 103I.301; 103I.401; 103I.451; 103I.501; 103I.525; 103I.531; 103I.535; 103I.541; 103I.621;  
HIST: 33 SR 211*

**4725.4900** [Repealed, 17 SR 2773]

**4725.4950** [Repealed 33 SR 211]

**4725.5000** [Repealed, 17 SR 2773]

#### **4725.5050 PRIMING WATER-SUPPLY WELL PUMPS.**

*A pump that requires priming for ordinary use must not be installed on a water-supply well unless the well is only used for a water irrigation system. An irrigation well pump must be primed only with water free of contamination and carrying a measurable chlorine residual. An irrigation well equipped with a centrifugal pump may be primed without chlorination when the pump is filled with water taken directly from the well.*

This does not prohibit the use of a jet or centrifugal pump, or prelube lines on turbines. It is intended to prohibit pumping equipment that requires opening of the well and introduction of water for each use. This requirement prohibits ordinary pitcher pumps.

*STAT AUTH: MS s 103I.101; 103I.221; 103I.301; 103I.621; 144.05; 144.12; 144.383; 157.04; 157.08; 157.09; 157.13  
HIST: 17 SR 2773*

**4725.5100** [Repealed, 17 SR 2773]

#### **4725.5150 WATER-SUPPLY WELL SUCTION LINE.**

*Subpart 1. **Construction.** As specified in part 4715.0510, a suction line for a water-supply well must be constructed of:*

Jet pumps operate by creating a partial vacuum, “drawing” water into the pump. When a jet pump is not located over the well, a single suction line (in the case of a shallow well jet pump), or a suction line and a pressure line (in the case of a two pipe or a deep well jet pump) connect the well with the pump. If the pipe is above ground (and not flooded) and a leak occurs, the pump will break suction and not work. If the line is buried, and a hole or other leak occurs, contaminants and near-surface water may be drawn into the

system, particularly if the soil is saturated. A suction line may only be buried if it is installed within an outer, concentric pipe with the annular space between the pipes filled with water from the system and maintained at system pressure (concentric piping). A diagram follows subpart 3.

Part 4715.0510 refers to the Minnesota Plumbing Code, water service pipe standards. The material standards from the Minnesota Plumbing Code are summarized after each material type.

#### *A. copper;*

The Minnesota Plumbing Code requires seamless-tube, Type K soft-temper or Type L soft-temper copper meeting ANSI Standard H23.1 or ASTM Standard B88 with brass or bronze flare fittings or cast bronze and wrought solder joint pressure fittings.

#### *B. galvanized iron or steel;*

The Minnesota Plumbing Code requires steel pipe to be Schedule 40 or above and meet ANSI Standard B36.1 or B36.20, or ASTM Standard A53, and wrought iron pipe must be Schedule 40 and above and meet ANSI B36.2. Fittings must be malleable fittings 150 pounds per square inch and above meeting ANSI Standard B16.3 or ASTM Standard A197, or steel unions meeting FS Standard WW-V-531 C. All exposed threads must be coal tar enamel coated and wrapped.

#### *C. cast iron;*

The Minnesota Plumbing Code requires cast iron-mechanical (gland type) pipe meeting ANSI Standards A21.11, A21.2, A21.4, A21.6, or A21.8 with water-service fittings meeting ANSI A21.10; and with bends, tees, and plugs anchored by rods; and thrust blocks or anchor rods behind all changes of direction of 45 degrees or greater.

#### *D. plastic pipe.*

The Minnesota Plumbing Code requires plastic pipe to be at least 150 pounds per square inch minimum working pressure for municipal water service and 100 pounds per square inch for other service. The materials allowed include: polyethylene meeting ASTM Standard D2239 or D2737, or ANSI Standard B72.1; ABS pipe meeting ASTM Standard D2282, or ANSI Standard B72.3; PVC pipe meeting ASTM Standard D2241 or D1785, or ANSI B72.2; and polybutylene meeting ASTM Standard D2662 or D2666.

*For well water irrigation systems, aluminum pipe may also be used.*

*Subp. 2. Extensions. A suction line extending outside the well casing must be protected by being:*

*A. fully exposed in a building as specified in part 4725.2175;*

### **BUILDING REQUIREMENTS**

- The building must be constructed at or above the established ground surface.
- If a floor drain is installed, it must discharge to the established ground surface, a gravel pocket, or a sewer constructed to prevent backup of sewage within 50 feet of the well.
- Materials or chemicals that may cause contamination of the well or groundwater, including fertilizers, pesticides, petroleum products, paints, and cleaning solvents, must not be stored in the building.

- Any door must be hinged to swing outward.
- There must be a durable watertight concrete floor.
- The building must be constructed exclusively to contain and protect the well, pump, water treatment equipment and water treatment chemicals. No other uses of the building are permitted.
- The building must not be contained in, or part of, another building, except that a well house may be constructed with not more than one wall in common with another building. The common wall must not allow access to, or be open to, the well house.

*B. fully exposed above the established ground surface; or*  
*C. installed within an outer, concentric pipe with the annular space between the pipes filled with water from the system and maintained at system pressure.*

Concentric piping is simply placing one pipe inside another, (see Figure 27). The inner (suction) pipe is protected by the outer (pressure) pipe. If a hole develops, surface water or soil will not be drawn into the water stem. On a shallow well system, the space between the pipes is filled with water at system pressure, but is not circulated. On a deep well suction system, the water between the pipes is circulated down the well to the jet or venturi as the “drive” water. Concentric piping is the only legal option for a buried suction line. Connecting concentric pipe requires a special concentric pitless, special fittings such as concentric seal crosses or ball elbows, and accurate cutting and careful assembly of pipes.

*Subp. 3. Exception. An unprotected suction line may be installed below the established ground surface for an irrigation well if the well is:*

- A. located in an agricultural field;*
- B. installed in an unconfined aquifer in unconsolidated material; and*
- C. used for a manifold collection system under negative pressure.*

*STAT AUTH: MS s 103I.101; 103I.221; 103I.301; 103I.621; 144.05; 144.12; 144.383; 157.04; 157.08; 157.09; 157.13*

*HIST: 17 SR 2773; 33 SR 211*



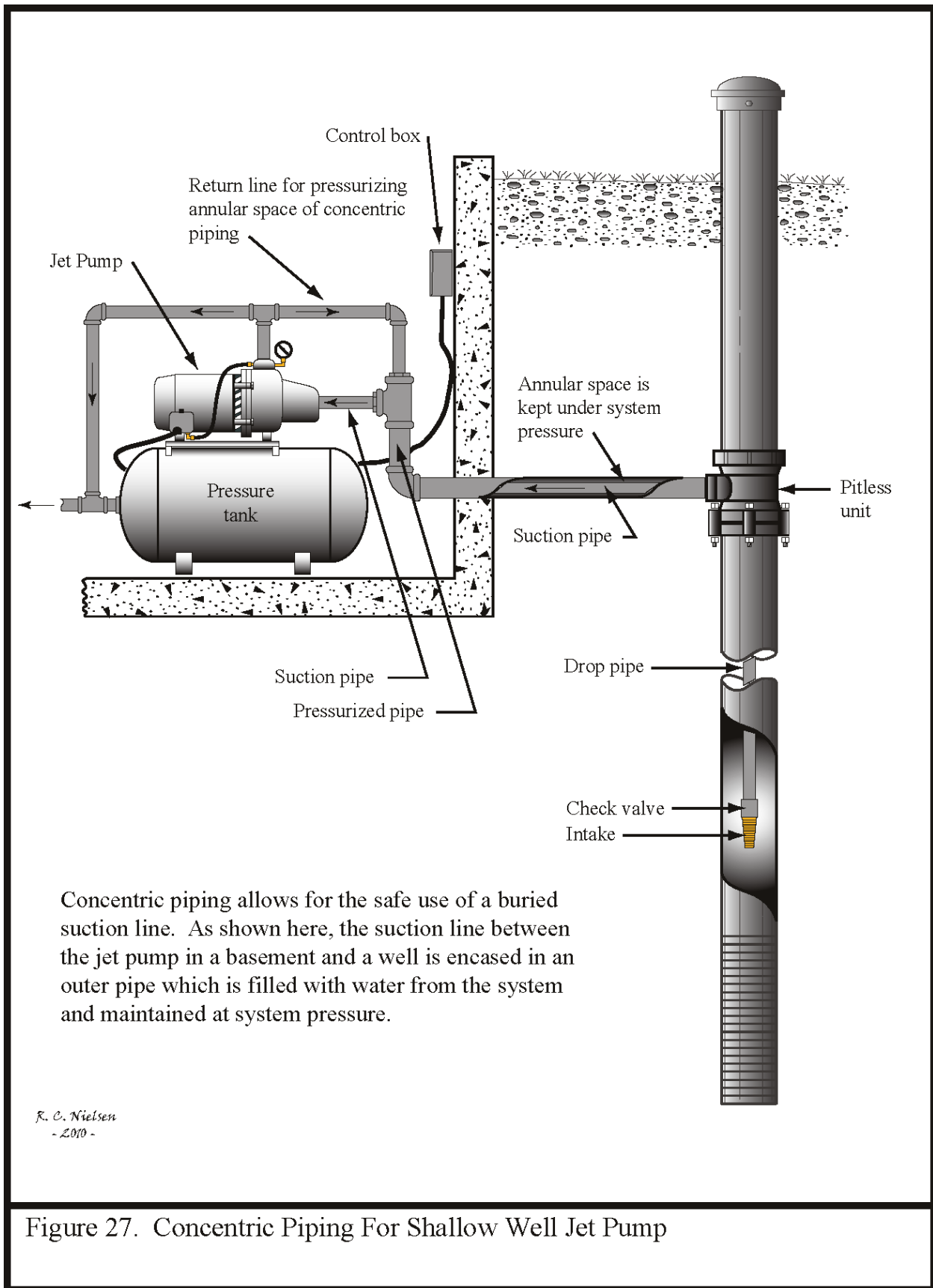

Figure 27. Concentric Piping For Shallow Well Jet Pump

**4725.5200 [Repealed, 17 SR 2773]**

**4725.5250 WATER-SUPPLY WELL PUMP DISCHARGE LINES.**

*A buried discharge line between a water-supply well casing and the pressure tank in an installation, including a deep well turbine or a submersible pump, must not be under negative pressure at any time. If a check valve is installed in a buried water line between the well casing and the pressure tank, the water line between the well casing and the check valve must meet the requirements of part 4725.5150 unless equipped with a vacuum release or combination air release and vacuum release device located between the check valve and the well. Pump discharge lines must be constructed of materials approved in part 4725.5150, subpart 1.*

Minnesota Rules, part 4725.5150 refers to suction lines, and contains the requirement for concentric plumbing. If a check valve is installed in the buried portion of the water discharge line, the piping must be concentric, unless a **vacuum-release** valve is installed. A vacuum-release valve may also be referred to as a vacuum air-release or vacuum-relief valve for water service. Devices such as the Watts N36 or equivalent provide vacuum protection but do not discharge trapped air. Devices such as the Val Matic model 100 through 116 provide protection from a vacuum and exhaust trapped air.

Minnesota Rules, Chapter 4725 require that pump discharge line materials be copper, galvanized iron or steel, cast iron, or plastic pipe meeting the standards of the Minnesota Plumbing Code, part 4715.0510, for water service pipe (water line between well and pressure tank). The requirements of the Minnesota Plumbing Code, part 4715.0510 are summarized above in Minnesota Rules, part 4725.5150, and are not found in the appendix.

The drop pipe or turbine column in a well is not considered part of the pump discharge line for purposes of these rules. The rules do not contain material standards for drop pipe or column.

**MINNESOTA PLUMBING CODE WATER-SERVICE LINE REQUIREMENTS**

In addition to the material standards for pump discharge lines (water service pipe) which reference the material standards of the Minnesota Plumbing Code, potable **water service lines** must meet the installation standards of the Minnesota Plumbing Code, part 4715.1710.

The Minnesota Plumbing Code requirements of part 4715.1710 are summarized below. The rule part is not reproduced in the appendix.

The Minnesota Plumbing Code requires a **10-foot separation between a water-service line and a building drain or sewer**. If a 10-foot separation cannot be maintained, the administrative authority (local government enforcing the Minnesota Plumbing Code) may allow the water and sewer line in the same trench, less than 10 feet apart, if the bottom of the water line is at least 12 inches higher than the sewer, and if the water pipe is placed on a shelf on one side of the trench. Both the sewer and water pipes must be air tested. Where the 10-foot separation cannot be maintained and the 12-inch vertical separation and location on the shelf cannot be maintained, the administrative authority may allow a closer separation if the sewer pipe is approved plastic or cast iron and the water pipe is copper, cast iron, or plastic and both are air tested. Where the water line must cross the sewer line, the water line must be at least 12 inches higher than the sewer within 10 feet of the crossing. Where this is not feasible, the sewer must be of approved materials from at least 10 feet on either side of the crossing.

The Minnesota Plumbing Code requires a water service line to be a minimum of 10 feet from a cesspool, septic tank, septic tank drainage field, seepage pit, soil treatment system, buried tank containing petroleum or chemicals, or any other source of pollution.

*STAT AUTH: MS s 103I.101; 103I.111; 103I.205; 103I.221; 103I.301; 103I.401; 103I.451; 103I.501; 103I.525; 103I.531; 103I.535; 103I.541; 103I.621; 144.05; 144.12; 144.383; 157.04; 157.08; 157.09; 157.13*  
*HIST: 17 SR 2773; 33 SR 211*

**4725.5300 [Repealed, 17 SR 2773]**

### **4725.5350 PRESSURE TANKS FOR WATER-SUPPLY WELLS.**

*Subpart 1. Venting. A pressure relief or air release valve on a pressure tank that contains subterranean gas and is located in a building must be vented to the outside.*

The venting requirement is intended to prevent the build-up of potentially toxic or explosive gasses (i.e., methane or hydrogen sulfide) in confined spaces (i.e., basements or well rooms) where pressure tanks are located. This applies primarily to hydropneumatic-pressure tanks without a bladder or other air-water separation (galvanized tanks).

Minnesota Rules, Chapter 4725 do not require a pressure release valve on a pressure tank, but one is recommended. In some circumstances, high-pressure submersible pumps can produce sufficient pressures to rupture (explode) a pressure tank. Typical submersible pumps are set with a 40 psi cut-in and 60 psi cut-out. A 75 or 80 psi release valve offers protection to pressure tanks that commonly have maximum (new) working pressure ratings of 90 to 125 psi.

*Subp. 2. Buried tanks. A buried or partially buried pressure tank installed on a water-supply well must:*

*A. be identified with the manufacturer's name, a serial number, the allowable working pressure, and the year fabricated;*

*B. have an interior coating that complies with ANSI/NSF Standard 61-2003e if the tank has an interior coating in contact with water;*

An interior tank coating is not required. However, if the tank has a coating, the coating must meet ANSI/NSF Standard 61. NSF publishes a quarterly booklet of listed products, their website contains a list, and products are marked with the NSF logo.

*C. have a minimum one-fourth inch wall thickness for a steel pitless adapter tank attached directly to the well casing;*

*D. have all connections to the pressure tank welded or threaded; and*

*E. be installed above the water table.*

A list of approved, buried pressure tanks is contained in the appendix.

A pressure tank with a galvanized interior coating or other component which exceeds 8 percent lead may not be used.

The DLI, Boiler Division, has reported that all water-pressure tanks using air as a pressurant, located in **commercial or public buildings, or in apartment buildings larger than a six-plex**, must be inspected and certified by the DLI. Pressure tanks located on public supplies serving businesses, churches, and communities are included.

Pressure tanks used in commercial or public buildings which are **120 gallons** or larger must be rated by the ASME. Tanks with volumes less than 5 cubic feet and having a 100 pound, ASME relief valve are exempt from the ASME tank rating requirements.

*STAT AUTH: MS s 103I.101; 103I.111; 103I.205; 103I.221; 103I.301; 103I.401; 103I.451; 103I.501; 103I.525; 103I.531; 103I.535; 103I.541; 103I.621; 144.05; 144.12; 144.383; 157.04; 157.08; 157.09; 157.13*

*HIST: 17 SR 2773; 33 SR 211*

**4725.5400** [Repealed, 17 SR 2773]

### **4725.5450 VENTING WATER-SUPPLY WELLS.**

*Subpart 1. Venting exceptions. A water-supply well must be vented unless the well:*

- A. is a flowing well;*
- B. casing is used as a suction pipe;*
- C. has a packer jet assembly;*
- D. is used as a remedial well; or*
- E. is constructed with a watertight seal in lieu of a casing extension as specified in part 4725.4350, subpart 2.*

A **vent** is required to eliminate negative pressure from occurring when the pump starts and the water level drops. Negative pressure can draw in contaminants through electrical conduits or other connections to the casing. A vent also exhausts toxic gases such as hydrogen sulfide which can cause asphyxiation in confined spaces such a well house, and exhausts explosive gases such as methane. **Vents are not required for** flowing wells, wells with packer-jet pumps, remedial wells, wells that use the casing as a suction pipe, and wells in areas where the regional flood level is more than 5 feet above the ground surface.

The venting requirement does not prohibit the use of a drawdown seal installed below the static water level in a well. However, the use of drawdown seals above the static water level is prohibited and the use of drawdown seals is generally not recommended.

*Subp. 2. Vent construction. A well vent must:*

- A. be constructed of materials complying with parts 4725.2250 to 4725.2650, or 4725.5150, subpart 1;*
- B. have watertight joints and terminate at least five feet above the regional flood level unless provided with a watertight seal as specified in part 4725.4350, subpart 2;*

*C. terminate a minimum of 12 inches above the established ground surface or the floor of a building as specified in part 4725.2175, except that a vent for a community public water-supply well must terminate a minimum of 18 inches above the established ground surface and the floor of a building as specified in part 4725.2175;*

*D. be screened with a noncorrosive mesh screen having openings of 1/16 -inch or less and pointed downward; and*

*E. be connected to the casing according to part 4725.4850.*

The vent must be constructed of well casing materials (Minnesota Rules, parts 4725.2250 through 4725.2650), or materials approved for pump suction and discharge lines (Minnesota Rules, part 4725.5150, subpart 1).

The regional flood is the 100-year flood and is explained in Minnesota Rules, part 4725.0100, subpart 40b. If the flood level is more than 5 feet above the ground surface, Minnesota Rules, part 4725.4350, subpart 2, allows the casing to terminate: 10 feet above the ground if a watertight seal without a vent is installed; 2 feet above the ground if an outer cement-grouted protective casing and waterproof threaded cap or compression seal are installed; or 2 feet above ground if a sealed, flowing well pitless, and a waterproof nonvented well cap are installed

The vent and the top of the casing must both terminate at least 12 inches above grade, or 12 inches above the floor of a well house. If the casing is exactly 12 inches above the ground surface and an overlapping cap with a built-in underside vent is used, the vent will terminate too low. In this case, the casing should be left more than 12 inches above-grade.

The vent for a **community public water-supply well** must be 18 inches above-grade as required in Minnesota Rules, part 4725.5850.

Screened openings must be 16 mesh or less (16 squares per inch, essentially window screen size) and be constructed of a noncorrosive material such as brass, aluminum, or fiberglass. Upside down “U”-shaped vents or “mushroom-type” vents may be used.

All vents, whether constructed on a water-supply well or another type of well, must meet the requirements of this part. The practice of drilling a hole in a casing is not an approved venting method.

*Subp. 3. Screened vents. A screened vent incorporated into the underside of a well cap or cover may be used.*

Minimum vent diameter or open area sizes have not been established; however, very small diameter vents on the underside of caps may provide inadequate air flow and result in the freezing of the vent in winter or plugging with debris. Also, it has been observed that some under-cap screens are not securely fastened to the cap and can fall out. Care should be taken to use a vent of adequate size, quality, and construction.

*Subp. 4. Gas. Any toxic or flammable gas must be vented from the well to the outside atmosphere.*

*STAT AUTH: MS s 103I.101; 103I.111; 103I.205; 103I.221; 103I.301; 103I.401; 103I.451; 103I.501; 103I.525; 103I.531; 103I.535; 103I.541; 103I.621; 144.05; 144.12; 144.383; 157.04; 157.08; 157.09; 157.13*

*HIST: 17 SR 2773; 33 SR 211*

## **4725.5475 HYDROFRACTURING WATER-SUPPLY WELLS.**

*Subpart 1. Scope. This part applies to hydrofracturing a water-supply well, as defined in part 4725.0100, subpart 30f. A remedial water-supply well, or other well or boring regulated by this chapter, must not be hydrofractured. Hydrofracturing must be done by a well contractor licensed according to Minnesota Statutes, section 103I.525.*

Hydrofracturing is the process of injecting water into (igneous or metamorphic) bedrock at pressures high enough to open existing fractures or create new fractures in order to increase water yield. Hydrofracturing uses one or more (typically two) inflatable packers to isolate a portion of the formation. This is done to concentrate the pressures in a more localized area, and avoid fracturing areas that may compromise the integrity of the well, produce sediment, or produce little water. The packer (or packers) is inflated, and high pressure water, commonly from 500 to 2,000 psi, is pumped into the formation. The water may open existing fractures wider, propagate fractures further, and in some cases create new fractures.

Hydrofracturing is not always successful, and carries risks. Hydrofracturing involves high pressures capable of damaging wells, affecting nearby wells, and causing injuries to workers and bystanders. Hydrofracturing a dry hole is rarely successful. Wells producing a few tenths of a gallon per minute to a few gallons per minute are the typical candidates for hydrofracturing. A hydrofracturing job is often considered successful if the yield increases from 1/2 to a few times the original.

Minnesota Rules, Chapter 4725 allow only a water-supply well completed in igneous or metamorphic rock to be hydrofractured. However, a variance may be granted for other wells or borings in appropriate situations. The variance allows for review of the specific circumstances. Only a “full” licensed well contractor (not a “limited” contractor) may hydrofracture.

### ***Subp. 2. Injection materials, water, and proppants***

*A. Water used for hydrofracturing must be potable water containing a chlorine residual. The use of surface water, unless obtained from a public water system, is prohibited.*

*B. Additives must meet the requirements of ANSI/NSF Standard 60-2003e as determined by a person accredited by the ANSI under ANSI Standard Z34.1-1993.*

*C. Proppants may be used to hold the joints and fractures open, and must be inert, clean, and nontoxic materials, including chlorinated, non-calcareous, washed sand.*

The rules do not allow surface water to be used for hydrofracturing, unless the surface water is the treated potable water from a public system that draws its supply from a surface water source.

“Proppants” are granular materials sometimes injected along with the water to hold fractures open. Proppants are not commonly used in Minnesota, but when they are, round quartz sand grains are typically used. Ceramic beads are less frequently used.

*Subp. 3. **Restrictions.** The following restrictions apply when hydrofracturing.*

*A. The upper packer must be a minimum of 50 feet below the established ground surface.*

*B. Hydrofracturing must not occur inside a casing. The upper packer must be a minimum of ten feet below the lower termination of a casing.*

*C. Hydrofracturing must only be done in igneous or metamorphic bedrock.*

*D. A water-supply well must not be hydrofractured unless located according to the isolation distances in parts 4725.4350 and 4725.4450.*

The restrictions are designed to prevent damage to the well casing, and prevent interconnection of surface or near surface contaminants with the well.

Examples of igneous or metamorphic bedrock include granite, gneiss, basalt, and quartzite. Sandstone and limestone are not igneous or metamorphic rocks.

In order to hydrofracture a new or old well, the well must be in compliance with all of the isolation or “setback” distances in rule.

A notification or permit is not required for hydrofracturing; however, reporting is required as described below.

*Subp. 4. **Requirements.** The following requirements apply when hydrofracturing.*

*The person hydrofracturing must:*

*A. remove additives injected during hydrofracturing;*

*B. disinfect a hydrofractured water-supply well upon completion of hydrofracturing, according to part 4725.5550.*

*C. collect a water sample from a hydrofractured water-supply well used for drinking or other potable purposes, and test the sample according to part 4725.5650; and*

*D. complete and submit a well and boring construction record, or amended record, within 30 days of completion of hydrofracturing.*

Additives do not include proppants, but do include any treatment chemicals injected.

The disinfection and water sample requirements are the same as for a new well since the hydrofracturing opens the well, injects water, and creates fractures that may connect new water sources.

If hydrofracturing is occurring at the time of well construction, a single well and boring construction record using the official preprinted form should be completed. If hydrofracturing occurs at a later date, and the contractor who drilled the well is hydrofracturing the well, the contractor may photocopy the original well record, amend the record to report the hydrofracturing, and submit the amended photocopy. If the contractor hydrofracturing the well did not drill the well, a “work copy” Well and Boring Record

should be completed. A search should be made for the Minnesota unique well number by looking for the well tag, searching County Well Index, or asking the well owner. If the Minnesota unique well number is found, it should be reported on the work copy; otherwise the well number should be left blank.

*STAT AUTH: MS s 103I.101; 103I.111; 103I.205; 103I.221; 103I.301; 103I.401; 103I.451; 103I.501; 103I.525; 103I.531; 103I.535; 103I.541; 103I.621*  
*HIST: 33 SR 211*

*4725.5500 [Repealed, 17 SR 2773]*



**End  
of  
Pitless, Pumps, Vents, Hydrofracturing Section**

## **4725.5550 WATER-SUPPLY WELL DISINFECTION.**

***Subpart 1. Disinfection procedure.*** *A water-supply well must be disinfected according to this part. A disinfection procedure is presumed adequate when one or more water samples collected as specified in part 4725.5650 indicate the absence of total coliform bacteria.*

“Total coliform bacteria” consist of approximately 20 different organisms that share some common features. For more information, see the discussion about coliform bacteria in Minnesota Rules, part 4725.5650, item A, and in the water quality section of the appendix. The total coliform test is relatively quick, easy, safe, and inexpensive. The total coliform test does not determine which species are present, but other tests can do this. Most of the coliform species are not harmful to humans. However, a small number can be, and the presence of coliform organisms serves as an indicator that the water sample and well may be impacted by surface water, or by animal or human wastes, since large numbers of coliform organisms live in the digestive tracts of warm blooded animals including man.

Disinfection with chlorine is a relatively inexpensive and usually successful process to rid a well of coliform organisms that have been introduced during drilling. However, coliform bacteria resulting from a defective casing or seal will only be eliminated temporarily. Also, in some cases such as highly turbid waters, or a well containing large numbers of nuisance (e.g., iron) bacteria, more than one disinfection may be needed to eliminate coliform bacteria.

The occurrence of coliform bacteria in new wells is usually caused by soil coliforms entering the well during the well construction process. This is particularly common for rotary drilled wells using bentonite drilling mud. Coliforms in the soil get mixed into the drilling mud, circulated down hole, and can be forced into the aquifer. Use of the cuttings as “grout” can add bacteria and shield the bacteria from the disinfectant, making disinfection difficult. In most cases, the organisms are harmless soil coliform species. However, tests that speciate the organisms have occasionally shown the presence of E. Coli. Coliforms forced into the aquifer, placed in cuttings behind the casing, or permeating the mud cake on the bore hole wall, may be difficult to remove. Disinfection may result in a negative sample, but bacteria that the disinfectant does not reach can multiply after the disinfectant is gone. Therefore, a single coliform “negative” result does not remove the contractor’s responsibility for coliforms introduced by the contractor when the well was constructed, or through an original defect in the well. The contractor may be required to disinfect again and resample.

***Subpart 2. Disinfection of new well or pump.*** *A person installing a new well or pump must ensure that the well is pumped until three volumes of the water contained in the well are pumped or until the water is as clear as groundwater conditions allow. After pumping, the person installing a new well or new pumping equipment must disinfect the well and pumping equipment with chlorine at a concentration sufficient to produce at least 50 parts per million of free chlorine in all parts of the well. The chlorine solution must contact the well surfaces above the static water level. The chlorine solution must remain in the well at least two hours before pumping all the chlorinated water from the well and the solution from the distribution system.*

A minimum of three casing volumes of water must be pumped from the well in order to remove drilling fluid, sediment, scale, and other materials which may harbor bacteria and use up the chlorine. A table of hole volumes is contained in the appendix. The quantity of water in the well is calculated by subtracting the static water level from the well depth and looking on the table for the casing or hole size. However, in cases of slow yielding wells, it is not necessary to remove three volumes if the well has cleared and the drilling fluid has been removed.

The well disinfection table provides information about obtaining a **50 parts per million chlorine** concentration. The table is based on water and a well with no chlorine demand, that is, a well free of bacteria, scale, rust, organics, or other oxidizable materials which will use up or “neutralize” the chlorine. Since this rarely, if ever occurs, in order to obtain 50 parts per million of chlorine in all parts of the well, it is necessary to add extra chlorine to overcome the “chlorine demand.” It is difficult to predict the chlorine demand. Chlorine test strips can be used to analyze the chlorine concentration, and adjust the amount of chlorine used. A more practical approach may be to add a dose of chlorine that results in more than a 50 parts per million solution, although the final concentration should be generally kept at or below 200 ppm. Higher chlorine concentrations, particularly of calcium hypochlorite (powdered or granular chlorine), can raise the pH and severely reduce the ability of the chlorine to eliminate bacteria and other organisms. The end of this section contains a discussion of methods that may be effective on problem wells.

The casing, drop pipe, wires, or pitless above the water level may hold bacteria that can later contaminate the water. Therefore, all portions of the well above the static water level must be contacted with the chlorine solution. The chlorine must either be mixed with water first, and then added through the top of the well casing, flushing the sides of the casing, or if the chlorine is added to the well directly, the chlorinated water must be recirculated through the top of the well.

In cases where a well contractor drills a well, but does not install the pump or water system, both the contractor constructing the well and the installer(s) of the water system must disinfect.

***Subp. 3. Disinfection during repair or modification. A person repairing or modifying a well or pump must disinfect the well as specified in subpart 2 or disinfect at the start of the repair or reconditioning by applying chlorine at a concentration sufficient to produce 200 parts per million free chlorine in all parts of the well for the period of the well repair or reconditioning operation. Before taking water samples or returning the well to use, all chlorinated water must be pumped from the well and distribution system.***

A water-supply well must be disinfected any time work is conducted inside the well, including installation of a new pump or drop pipe, removal or installation of a screen, development or treatment, or installation of a pitless. Disinfection is not required if only a well cap is replaced.

Subpart 3 provides an alternative to the disinfection procedure in subpart 2 for well repair, so that contractors do not have to wait for two hours after the job is completed. If the chlorine solution is added when well repair is started, it must be strong enough to maintain a concentration of at least 200 parts per million free chlorine for the period of the well repair.

Relatively low concentrations of chlorine can be detected by smell; however, the nose can be easily desensitized. Chlorine test strips are an easy method for determining the presence and concentration of chlorine.

**Subp. 4. Disinfection materials.** Chlorine materials must meet the requirements of ANSI/NSF Standard 60-2000e as determined by a person accredited by the ANSI under ANSI Standard Z34.1-1993 or be registered by the United States Environmental Protection Agency according to the Federal Insecticide, Fungicide, and Rodenticide Act (FIFRA) section 3(c)(7)(A), as an antimicrobial pesticide for use in potable water. Chlorine compounds with additives such as perfumes or algaecides must not be used for disinfection. An alternate disinfection material may be used if the material is a biocide meeting the material and use standards of this part and provides biocidal activity equivalent to the chlorine concentrations and contact times required in this part.

Chlorine compounds must be sodium or calcium hypochlorite without additives. Some laundry or swimming pool chlorine products contain fungicides, algaecides, or perfumes. These products must not be used.

Sodium hypochlorite is a liquid and is the active ingredient in common liquid laundry bleach. Laundry bleach has a chlorine concentration of approximately 5 to 6 percent, typically near 5.25 percent when new. Liquid sodium hypochlorite is also available at many swimming pool or chemical supply houses that contains up to 15 percent chlorine, typically near 12 percent. The chlorine is somewhat unstable and will lose strength after approximately 60 days, so it is important to use fresh sodium hypochlorite. Calcium hypochlorite is available in solid form at concentrations of 35 to 75 percent chlorine, typically near 65 percent. Calcium hypochlorite will retain its strength over longer periods of time if kept cool and dry. While calcium hypochlorite contains more available chlorine, it raises the pH causing substantially reduced biocidal activity, and will not completely dissolve when dumped into a well in solid form.

Alternative disinfection materials such as hydrogen peroxide, iodine, and potassium permanganate have been used to very limited extents in other states or for special applications. Until this rule, chlorine has been the only product allowed for new well disinfection. This rule allows alternative disinfectants if the product is equivalent to chlorine. Prior to use of an alternative disinfectant for compliance with this rule, contact the MDH for details of use.

**Subpart 5. Chlorine in solid form.** Chlorine compounds in solid form used to comply with subparts 2 and 3 must be dissolved in potable water prior to placement in a water-supply well or circulated in the well to contact all well surfaces above the static water level, except that:

A. additional solid chlorine in excess of that necessary to produce the free chlorine required in subpart 1 or 2 may be added; and

B. solid chlorine may be used to disinfect a flowing well by placing the solid in the bottom of the well.

Calcium hypochlorite is a solid, in powder, granular, or tablet form. If the solid material is dumped down a well without dissolving in water, it will not disinfect the casing and pump components above the static water level and may lead to the product sinking into loose sediment and not dissolving, or building up on top of the pump and not effectively disinfecting the well below the pump. The solids built up on the top of the pump can also accelerate corrosion of the drop pipe causing the pump to separate from the drop pipe. For those reasons, it is required to dissolve calcium hypochlorite in water to obtain a minimum free

chlorine concentration. Once that concentration is reached, solid hypochlorite may be added to the well without dissolving in water first. Dissolving hypochlorite in water first is also not required for disinfecting flowing wells when it is placed in the bottom of the well, or when it is used for disinfection of old wells.

***Subpart 6. Remedial well exemption. The requirement to disinfect a water-supply well does not apply to a remedial well if the disinfection will interfere with water quality analysis or create dangerous reactions with contaminants.***

**\* AMOUNT OF 5.25 PERCENT HYPOCHLORITE LAUNDRY BLEACH FOR WELL DISINFECTION**

(Mix with ten times as much water before adding)

Well Casing Diameter	Distance From Water Level to Bottom of Well					
	0'-50'	50'-100'	100'-200'	200'-300'	300'-400'	400'-500'
up to 2"	1 oz.	2 oz.	4 oz.	6 oz.	8 oz.	11 oz.
2" - 4"	4 oz.	8 oz.	1/2 qt.	1 qt.	1-1/4 qt.	1-1/2 qt.
4" - 6"	8 oz.	1/2 qt.	1 qt.	1 qt.	3/4 gal.	3/4 gal.
6" - 8"	1/2 qt.	1 qt.	3/4 gal.	1 gal.	1-1/4 gal.	1-1/2 gal.
8" -12"	1/2 gal.	3/4 gal.	1-1/4 gal.	1-3/4 gal.	2-1/2 gal.	3 gal.
12" -16"	1/2 gal.	1 gal.	2 gal.	3 gal.	4 gal.	5 gal.
16" -20"	3/4 gal.	1-1/2 gal.	3 gal.	5 gal.	6 gal.	8 gal.
20" -24"	1 gal.	3 gal.	5 gal.	7 gal.	9 gal.	11 gal.
24" -30"	2 gal.	4 gal.	7 gal.	11 gal.	14 gal.	18 gal.
30" -36"	3 gal.	5 gal.	10 gal.	15 gal.	20 gal.	25 gal.

oz. = ounces    qt. = quarts    gal. = gallons

\* The quantities of bleach listed will result in an approximate 50 part per million (ppm) concentration of chlorine in the well. The chlorine demand of the well will use some of the available chlorine, so more bleach must typically be added to maintain a 50 ppm concentration

\* In order to achieve a chlorine concentration of 200 parts per million for well repair, or shock chlorination to reduce iron bacteria, multiply the quantities in the table by four.

**EXAMPLE 1:**

The well is 4 inches in diameter and the depth of the well is 400 feet. The water level is 100 feet. 400 feet – 100 feet = depth of water in the well (300 feet). From the table, a 4-inch well with 300 feet of water takes 1 quart of bleach.

**EXAMPLE 2:**

The well is 1-1/2 inches in diameter and the depth of the well is 42 feet. The water level is 19 feet. 42 feet – 19 feet = 23 feet of water in the well. From the table, a 1-1/2 inch well with 23 feet of water takes 1 ounce of bleach.

**EQUIVALENT AMOUNT OF LIQUID BLEACH (5.25 PERCENT SODIUM HYPOCHLORITE) AND (SOLID) 65 PERCENT CALCIUM HYPOCHLORITE**

<u>5.25% Sodium Hypochlorite (Laundry Bleach)</u>	<u>65% Calcium Hypochlorite</u>	
	<u>Tablets</u>	<u>Powder or Granular</u>
2 Tablespoons	1/2 Tablet	3/4 Teaspoon
1/4 Cup (2 ounces)	1 Tablet	1-1/2 Teaspoon
2 Cups	8 Tablets	3 Tablespoons (2 ounces)
1 Gallon	65 Tablets	2 Cups (16 ounces)

**DISINFECTION COMMENTS**

In the case of large-diameter dug wells, flooded wells, wells with high concentrations of sediment, iron, or slime forming bacteria, a greater quantity of chlorine solution, multiple disinfections, or additional actions will usually be needed to accomplish the disinfection because of the greater chlorine demand.

Techniques that can increase the effectiveness of disinfection include:

- Pumping, bailing, airlifting or using other methods prior to disinfection to remove suspended solids, scale, and debris;
- Physical cleaning and agitation of the well with brushes, bailer, airlift, surge block, jetting tool or other development technique before, and during chlorination;
- Circulation of the chlorine solution in the well to wash down the casing and reach all parts of the well; and
- Dosing the well with large quantities of chlorinated water to force chlorinated water out the screen or open hole. As a general rule, 1 gallon of laundry bleach in 1,000 gallons of water will achieve a chlorine concentration of 50 parts per million.

As chlorine concentrations increase, so does the pH of the water (the water becomes more alkaline). The higher pH converts the chlorine into an oxidizer, not a biocide. The solution becomes better at creating rust (iron oxide) than destroying bacteria. Some techniques can be used to keep the pH in the optimal range around neutral or slightly acid (5.5 - 7):

- Metering the chlorine solution to maintain an effective dose, but keeping concentrations at 200 ppm or below;
- Using sodium hypochlorite instead of calcium hypochlorite which raises the pH more;
- Doing multiple disinfections;
- Circulating the water to maintain mixing, contacting all surfaces, and physically loosening deposits; and
- Controlling the pH by the careful use of acids. **Acid and chlorine can be a deadly mixture.** Proper safety precautions should be taken. Products such as vinegar or citric acid can be safer than muriatic or hydrochloric acid.

The elimination of coliform bacteria is dependent on conditions in the well and water system, but also highly dependant on the source of the bacteria. A water sample may contain coliform bacteria for a number of reasons including:

- Organisms introduced into the well during drilling or repair;
- A defect in the well such as a cracked casing or defective fitting. Most problems of this type occur near the frost line at the pitless adapter or a near-surface casing joint;
- A flooded well;
- Rodents or insects entering the well thru an unsealed electrical connection or defective cap, or soil blown into the well or drawn in due to a vacuum caused by a pump start;
- Coliform contamination in the aquifer. This is not common except for wells very near contamination sources, very shallow wells in porous formations such as coarse gravel, and wells in highly fractured or cavernous formations such as limestone;
- Repair to the plumbing or water system;
- Cross connections in the plumbing such as a submerged hose;
- Poor sampling, such as collection of a sample from a garden hose or swing faucet where coliform may be present and result in a positive sample.

If coliform have entered the well or water system, it is likely that they are distributed throughout the plumbing. If only the well and a portion of the plumbing are disinfected, it is possible for the bacteria to multiply and spread throughout the water system. In general then, it is advisable to disinfect the entire water system, including fixtures. It should be noted however, that high chlorine concentrations, or particulates released into the water during disinfection may plug or damage sensitive fixtures such as washing machine solenoid valves, sprinkler heads, and others. It may be necessary to isolate problem areas and disinfect the well with higher concentrations, while disinfecting portions of the plumbing with lower concentrations or shorter contact times. Isolating the system may also pinpoint whether the problem is coming from the well or the plumbing.

*STAT AUTH: MS s 103I.101; 103I.111; 103I.205; 103I.221; 103I.301; 103I.401; 103I.451; 103I.501; 103I.525; 103I.531; 103I.535; 103I.541; 103I.621  
HIST: 33 SR 211*

**4725.5600** [Repealed, 17 SR 2773]

**4725.5650 WATER QUALITY SAMPLES FROM NEWLY CONSTRUCTED POTABLE WATER-SUPPLY WELL.**

*Within 30 days of completion and before the use of a newly constructed potable water-supply well, the person constructing the well must assure that a water sample is collected from the well. A water sample is not required from a new pump installation in an existing well, or a well repair, unless a notification must be submitted according to part 4725.1820, item A.*

A water sample must be collected before using a well for potable purposes, including human contact such as handwashing.

A water sample is not required to be taken from:

- A **repaired well** unless a notification is required (notification is required if a well is deepened through a confining layer, or if casing is installed or removed below the frost line);
- An existing well that has a **new pump or screen** installed; or
- A nonpotable well (a well used **only** for purposes that do not involve drinking, cooking, preparation of food, distribution to plumbing fixtures, or other human contact).

While it is not required, it is recommended that a repaired well or a well with a new pump be sampled and tested for total coliform and nitrate-nitrogen.

Disinfection of a well that has been repaired or had a pump replaced is required.

The contractor who **files the notification** is responsible for collecting the sample or making sure that the sample is collected. The sample may be collected by the contractor directly, the laboratory, a county sanitarian, or by the property owner. If the sample is to be taken by the property owner, clear and detailed instructions should be given. If the property owner does not collect a sample or if a resample is needed, the contractor remains responsible for sampling.

*A. The person constructing the well must inform the well owner that until analysis of one or more water samples from the well indicates the absence of total coliform bacteria, and the nitrate-nitrogen and arsenic analysis have been completed and reported, the well must not be used for human consumption.*

The “**person constructing the well**” refers to the licensed well contractor who files the notification. The contractor must inform the owner that the well water must not be used for drinking until a bacteriologically safe sample is obtained, and the nitrate-nitrogen and arsenic water sample results from the well are provided to the well owner. It is not required that this notice be in writing (the analysis results must be given to the owner in writing when completed), and the MDH does not have a form. However, to avoid confusion and potential liability, it is recommended that the information be provided in writing. The information could be included on the bid, proposal, or contract.

The absence of total coliform bacteria is determined by **testing** a properly collected water sample by a method which has been accepted by the EPA or Standard Methods. Approved coliform testing methods include the Most Probable Number (MPN), Membrane Filter (MF), and the defined substrate (Colilert, Colisure and equivalent). Even though the standard is effectively “0” total coliform bacteria, a “0” or “negative” result is not normally reported as “negative” or “0”, but is reported as “less than” a number, or the “absence” of total coliform:

<u>TEST</u>	<u>ABSENCE OF COLIFORM TYPICALLY REPORTED AS</u>
Most Probable Number (MPN)	< (less than) 2.2 organisms per 100 ml
Membrane Filter (MF)	< (less than) 1 organism per 100 ml
Presence/Absence (Colilert, Colisure, etc)	Absent

The presence of any coliform bacteria indicates unsatisfactory bacteriological quality.

Additional information concerning coliform bacteria is located in Minnesota Rules, part 4725.0100, and in the appendix under “water quality.”



*B. The person constructing the well must assure that water samples are properly collected and submitted to a laboratory certified under parts 4740.2010 to 4740.2120. The laboratory must be certified to analyze total coliform bacteria, nitrate-nitrogen, and arsenic, under the safe drinking water program test category. The laboratory reporting limit must be no greater than 1.0 milligrams per liter for nitrate-nitrogen, and no greater than 2.0 micrograms per liter for arsenic.*

Minnesota Rules, parts 4740.2010 to 4740.2120 are MDH rules concerning the certification of laboratories. In order to test new well samples, the laboratory must be certified by the MDH. A list of certified laboratories is available from the MDH, and on the MDH Web site at [www.health.state.mn.us/labsearch](http://www.health.state.mn.us/labsearch).

The water sample should be collected from a sampling tap as close to the well as possible. Water treatment devices may interfere with the analysis and should be bypassed. A sample may be collected directly from the well discharge, directly from the well by use of a sampling pump or device, or through the drop pipe or drill rods. However, sampling directly through a bailer, sochris pump, or drill rods, or by airlifting, may result in a coliform positive. If an inside faucet is used, a tap without a swing joint should be chosen. Aerators and gaskets should be removed.

**COLIFORM BACTERIA SAMPLING.** If possible, the faucet outlet should be flamed with a propane torch to kill surface bacteria. As an alternative, the faucet outlet can be cleaned with alcohol or chlorine, but must be flushed to remove the chemicals. Care should be taken not to burn gaskets, siding, or plastic fittings if a torch is used. The water should be run for at least 5 minutes after the pump starts. The sample should not be taken if chlorine is present. Chlorine can be detected by smell or by a potassium iodide starch test paper. The total coliform sample must be collected in a sterile container provided by the testing laboratory. Typically, a 125 milliliter (4 ounce) plastic bottle is used, that often has a fill line mark. The inside of the bottle and cap should not be touched. The bottle should be filled according to the laboratory instructions, typically leaving about 1/2-inch of air space to allow for mixing. Since bacteria are living organisms and can die or multiply depending on conditions, there is a maximum holding time, usually 30 hours, from the time of sample collection until the sample arrives at the laboratory. Samples older than 30 hours will be rejected.

**NITRATE SAMPLING.** When a well is tested only for total coliform bacteria and nitrate-nitrogen, the coliform sample bottle described above is typically used for both tests. If a separate nitrate sample is taken, the laboratory may use the coliform type bottle, or a nonsterile general chemistry bottle. In most cases only an ounce or two is need for analysis. The sample should be kept cool, and typically has a 14-day maximum holding time.

**ARSENIC SAMPLING.** Some laboratories may provide a bottle containing an acid preservative for arsenic sample collection, or provide a vial of acid to be added immediately after collection. Alternatively some labs will add the acid when the sample is received at the laboratory. It is important to use the correct bottle(s) provided by the lab. The arsenic bottle is commonly a 250 ml (8 ounce) plastic bottle.

Plastic bottles should not be written on with ink or marker. Identification should be written on a label.

Bottles have an expiration, often six months to a year for bacteriological tests, and one year to 18 months for others. Expired bottles should be returned to the laboratory.

*C. The sample must be analyzed for total coliform bacteria, arsenic, and nitrate-nitrogen. The person constructing the well must assure that the property owner and the commissioner receive a legible, reproducible copy of the analysis results within 30 days of analysis. The copy of analysis results sent to the commissioner must include the unique well number, the property owner's name and address, and the dates of sample collection and analysis.*

Contractors must make sure that the MDH Well Management Section (or in the jurisdiction of a delegated well program, the local program) and the well owner receive a duplicate or photocopy of the **water test results** provided by the certified laboratory that performed the tests. Results that have been transcribed onto another form are not acceptable. Contractors may send the results directly to the MDH Well Management Section (or delegated well program) and well owner, or may make arrangements to have the laboratory mail out the results. However, it is the contractor's responsibility to make sure the results are sent.

The water sample analysis card is part of the four-part package of well notification, well record, metal well tag, and water sample analysis card. This card may be filled out and mailed with the water sample to the certified lab. Neither the card nor the water sample should be sent to the MDH. The MDH does not do analysis of new well water samples. The verified **water sample analysis results** must be sent to the MDH Well Management Section within 30 days of collection of the sample.

Failure on the part of a well owner to pay the bill for a well is not justification for failure of the contractor to send the water analysis results to the MDH Well Management Section.

*D. If a water sample collected according to this part, or a water sample collected by the commissioner from a newly constructed potable water-supply well indicates the presence of total coliform bacteria, the person constructing the well is responsible for actions needed to eliminate possible causes of total coliform bacteria, disinfect the well, and resample for total coliform bacteria.*

**Coliform bacteria** may result from a number of possible sources: improper sample collection, contamination from the drilling process introducing soil coliform bacteria, contaminated drilling water or drilling additives, surface water entering the well through a casing defect or ungrouted annulus, runoff or infiltration from such sources as septic systems or feedlots, or bacteria resulting from pump or plumbing installation or repair. Total coliform bacteria may exist "naturally" in an aquifer, but in most cases they do not. Most new well total coliform bacteria positives are a result of well construction, pump installation, or plumbing work introducing bacteria into the water system. While most new well coliform positives are from "environmental" organisms that are not harmful, the test does not differentiate, and fecal organisms have been found in new wells, likely from feces in the soil carried into the well during drilling or pump installation. Because of this, the person(s) who worked on the well will be held responsible for elimination of the bacteria, unless it is evident that the bacterial source is not related to the well work.

Nitrate and arsenic are a different matter. The well and boring rules do not require the contractor to provide nitrate or arsenic-free water so long as the well is constructed to the standards of the rules. Aquifers, especially shallow, highly permeable, and fractured rock aquifers may be contaminated with nitrate, generally as a result of agricultural fertilizers or septic systems. Arsenic contamination is generally a result of “natural” arsenic dissolved from arsenic-bearing minerals in the sediment or rock. Nevertheless, it’s always a good idea to avoid aquifers with elevated nitrate or arsenic where possible. If a different aquifer may yield better quality water, that option should always be discussed with the prospective well owner.

*STAT AUTH: MS s 103I.101; 103I.111; 103I.205; 103I.221; 103I.301; 103I.401; 103I.451; 103I.501; 103I.525; 103I.531; 103I.535; 103I.541; 103I.621; 144.05; 144.12; 144.383; 144.87; 144.98; 157.04; 157.08; 157.09; 157.13*  
*HIST: 17 SR 2773; 31 SR 446; 33 SR 211*

**4725.5675** *[Repealed, 33 SR 211]*

**4725.5700** *[Repealed, 17 SR 2773]*

## **4725.5750 DUG WATER-SUPPLY WELLS.**

A “**dug well**” is a water-supply well constructed by digging by hand, back hoe, bucket auger, excavating or boring machines, or other “unconventional” equipment. Historically, dug wells were lined or cased with stone, brick, wood, tile, concrete, or other nonwatertight casing. Dug wells obtained water from the loose joints, bottom, and often the surface, creating water quality issues. Dug wells also presented safety issues due to their often large diameter. Dug wells are sometimes referred to as “bored, augered, crock, curbed, or tile” wells.

Previous rules allowed the use of concrete curbing or poured concrete subject to a number of restrictions. Even with these precautions, a large percentage of concrete curbed dug wells demonstrated contamination, so that in 2008 the use of concrete curbing or poured concrete was no longer permitted for new wells. Existing wells may be still used and repaired, and new dug wells may be constructed using conventional casing. Steel, and more recently plastic, casing is made in larger diameters, and can be made with watertight joints.

***Subpart 1. Construction.** A dug well must be constructed in accordance with all requirements of this chapter including the materials, grouting, and casing standards. Where geological conditions preclude the possibility of completing a water-supply well with conventional drilling methods, materials, or casing, a variance may be granted under part 4725.0410 to install a dug well for a residential water supply using unconventional techniques or materials. A dug water-supply well may only be constructed in an unconsolidated formation.*

All requirements of the general well and boring rules, and the water-supply well rules including grouting, multiaquifer well prohibitions, and inner/outer casing combinations, apply to dug wells. A dug well may not obtain water from more than one aquifer.

As an alternative to concrete or other older dug well materials, large diameter steel and plastic well casing are made. Hydrofracturing can be used in conventional wells in some circumstances where before, a conventional well would not produce an adequate quantity of water. Larger or multiple pressure tanks can be installed on low yielding conventional wells. For those cases where unique geology may make completion of a conventional well unlikely, a variance may be applied for to modify the required materials or methods. The variance allows for review of the site-specific conditions, allows the well owner to be fully informed of the risks, and allows precautions to be taken.

***Subp. 2. Cover.** A dug water-supply well must be protected with a cap or cover meeting the requirements of part 4725.3150, subpart 1, or a precast, overlapping, steel-reinforced, concrete cover at least four inches in thickness, or a locked, overlapping, metal cover at least 3/16 inch in thickness. The junction of cover with the well casing must be made with a watertight gasket and must be provided with a well vent according to part 4725.5450.*

*Subp. 3. **Watertight openings.** A pump opening and a connection below the established ground surface for a dug water-supply well must be made watertight in accordance with part 4725.4850, subpart 1, or with concrete or cement.*

A “buried slab” construction of installing a small diameter upper casing and pitless on a large diameter dug well is not approved.

*Subp. 4. **Location.** Unless a dug water-supply well is grouted from the surface to a depth of 50 feet or through a confining layer, the well must be located according to part 4725.4450, subpart 2.*

This subpart applies to contamination sources placed near existing dug wells. Minnesota Rules, part 4725.4450, subpart 2, item A requires **twice the isolation distance between contamination sources entering the soil and “sensitive” wells**. Sensitive wells include wells with screen, open hole, or water intake areas within 50 feet of the surface or that don't penetrate 10 feet of a confining layer. The rules now require grouting of new (dug) wells to a depth of 50 feet. However, many old dug wells still exist, and the rule requires that new contamination sources not be placed closer to existing wells than the setbacks in rule.

*STAT AUTH: MS s 103I.101; 103I.111; 103I.205; 103I.221; 103I.301; 103I.401; 103I.451; 103I.501; 103I.525; 103I.531; 103I.535; 103I.541; 103I.621; 144.05; 144.12; 144.383; 157.04; 157.08; 157.09; 157.13*

*HIST: 17 SR 2773; 33 SR 211*

**4725.5800** [Repealed, 17 SR 2773]

## **4725.5825 PUBLIC WATER-SUPPLY WELLS.**

*Subpart 1. Requirements. In addition to the requirements of parts 4725.2010 to 4725.5650, a water-supply well used to provide water for a noncommunity or community water system must comply with the requirements in subparts 2 to 6.*

A well used to supply a public water system must meet the general well and boring requirements, the water-supply well requirements, and the requirements of this part. In addition, community public wells must also meet the requirements of the following rule part.

Public water systems consist of community public systems and noncommunity public systems.

A community public system must serve at least 15 service connections (homes, residences, apartments, living units) used by year-round residents, or regularly serve at least 25 year-round residents. Examples of facilities that are often community public systems include: cities, housing developments, mobile home parks, and extended health care facilities.

A noncommunity water system must serve an average of at least 25 persons at least 60 days a year at a place other than their home. Examples of facilities that are often noncommunity water systems include: restaurants, churches, schools, resorts, parks, camps, rest areas, and businesses.

*Subpart 2. Notification of drilling required. The licensee must notify the commissioner of the proposed construction starting time of a community or noncommunity public water-supply well 24 hours in advance of beginning construction. The information may be placed on the notification form required in part 4725.1820 or may be reported by telephone, facsimile, or in person. The notification must be made between the hours of 8:00 a.m. and 4:30 p.m. Monday through Friday, excluding holidays.*

In lieu of requiring plan submission and approval for noncommunity system wells, the MDH committed to the U.S. EPA (who regulate public water systems and who have delegated the federal program to the state) that the MDH would inspect all public wells, and do the inspection during construction if possible.

The proposed construction starting day and time may be reported by telephone to the MDH Well Management Section, St. Paul office at 651-201-4600, or to the appropriate MDH Well Management Section district office. If a district office is contacted, it is important that the contractor talk to a staff member. If a staff member is not available, the main St. Paul office should be contacted.

*Subp. 3. Additional disinfection or development required. A public water-supply well constructed in an unconsolidated formation using a rotary or other method that creates an annular space and uses a bentonite drilling fluid, in addition to the disinfection requirements of part 4725.5550, must be either:*

*A. disinfected upon completion of drilling and prior to grouting by placing a minimum 200 mg/l free chlorine solution in the bottom of the well, and circulating the solution both inside the casing and in the annular space to the established ground surface for a minimum of 30 minutes; or*

*B. developed by agitating and forcing water out of the screen for a minimum of one hour.*

The MDH has observed a high percentage of noncommunity public wells, drilled with mud rotary, completed in unconsolidated formations, that show total coliform, and in a few cases, fecal coliform. Some wells have taken up to one year to obtain a bacteriologically safe sample. This has resulted in severe hardships for the well owner (often a hotel, restaurant, resort, etc.) that has had to use an alternative water source. A study was commissioned by the MDH to attempt to determine the source(s) of the bacteria, and methods for elimination. Evidence points to the source of the bacteria being soil organisms that are mixed into the bentonite drilling mud as the hole is drilled, circulated down the bore hole, and are forced into the formation, remain in the filter cake, or are in the cuttings used to fill the space around the casing below the surface grout. Typical disinfection after the casing is set and grouted does not reach these organisms behind the casing and in the formation.

The MDH study, as well as work done by the Michigan Department of Environmental Quality, has shown that disinfection prior to grouting and development are simple and effective techniques for eliminating bacteria. Chlorination of the drilling mud was also found to be successful. Other techniques that can reduce coliform positives include: the use of driven surface casing to minimize contact with surface soils containing bacteria; replacing the drilling mud after drilling the top portion of the hole to eliminate the circulation of soil coliform down the well; and keeping drilling tools, pumps, drop pipe and other tools clean and off the ground.

*Subp. 4. Grouting required. A public water-supply well constructed with a method that creates an open annular space must be grouted as specified in part 4725.3050 from within ten feet of the lower termination of the casing to the established ground surface or base of the pitless adapter or unit. Casing may be driven in accordance with part 4725.3050, subpart 5.*

All public wells, including not only municipal wells, but public wells serving parks, restaurants, churches, and businesses must be “full length” grouted if drilled by rotary or other method that drills a bore hole larger than the casing. This full-length grouting requirement applies to all casings, including outer or “surface” casings. This rule provides a higher level of safety for public water-supply wells, since public water supplies provide water to large populations; serve vulnerable populations such as schools, nursing homes, or day care centers; serve transient populations such as fairs and rest stops where waterborne disease has the potential to spread quickly and far; and because the public well radius of influence (area of the ground that supplies water to a well) can be large.

*Subp. 5. Sampling faucet required. A sampling faucet must be installed for each new public water-supply well. The faucet must be:*

*A. metal;*

*B. installed a minimum of 12 inches above the established ground surface or floor; and*

*C. installed before any treatment devices and between the well and water storage.*

*Subp. 6. **Conversion to a public water-supply well.** A well, previously not used as a public water-supply well, may be used as a noncommunity or community public water-supply well only if the well meets the standards of this chapter. Plans and specifications must be submitted to, and approved by, the commissioner prior to use as a public water-supply well. This provision is not meant to be used for the construction of a “test” well or environmental bore hole converted to a public water-supply well in order to circumvent the notification, inspection, and plan approval requirements of this chapter.*

This rule requires that new or existing wells constructed for private supply or purposes other than public supply, may not be converted to use as a public well unless the well meets the standards of the current rules. It is therefore highly recommended that when constructing a well that is not going to be used now for a public supply, but has a potential, such as well for a small business that has plans for expansion, the well be drilled to the standards of a public supply.

There are some circumstances where a variance may be granted to allow an existing well that does not meet current standards, to be used for a public supply. Special testing, protection, or other requirements may be necessary. Prior to submission of a variance request, it is recommended that the MDH be contacted.

The rule is not designed to allow “test wells” drilled without inspection or approval as environmental bore holes to evaluate the potential for a public supply, to be “converted” to a public supply.

*STAT AUTH: MS s 103I.101; 103I.111; 103I.205; 103I.221; 103I.301; 103I.401; 103I.451; 103I.501; 103I.525; 103I.531; 103I.535; 103I.541; 103I.621;  
HIST: 33 SR 211*

#### **4725.5850 COMMUNITY PUBLIC WATER-SUPPLY WELLS.**

*Subpart 1. **Requirements.** In addition to the requirements of parts 4725.2010 to 4725.5825, a public water-supply well used to provide water for a community water system must comply with the requirements in subparts 1a to 8.*

A “**community public water system**” is a water system which serves at least 15 service connections used by year-round residents, or regularly serves at least 25 year-round residents for at least six months of the year. These systems include: municipalities, mobile home parks, extended-health-care facilities such as nursing homes, and apartment buildings.

*Subpart 1a. **Approval of plans and specifications.** A licensee must not construct or materially alter a well, including adding or removing casing below the frost line for a well providing water to a community water system, until plans and specifications have been approved according to part 4720.0010.*



Plans and specifications must be submitted to and approved by the MDH, Drinking Water Protection Section prior to constructing a community public water-supply well. The well owner is responsible for submitting the plans. The well contractor must not begin construction of the well until the plans have been submitted and approved, and is responsible for drilling the well in conformance with the plans and the rules.

Well plans are not required for noncommunity public wells.

Minnesota Rules, part 4720.0010 of the public water supply rules states: “No system of water supply or system for the disposal of sewage, industrial waste, garbage, or refuse, in case any such system is for public use or for the use of any considerable number of persons, or in case any such system affects or tends to affect the public health in any manner, shall be installed by any public agency or by any person or corporation, nor shall any such existing system be materially altered or extended, until complete **plans and specifications** for the installation, alteration, or extension, together with such information as the commissioner of health may require, have been submitted in duplicate and approved by the commissioner of health insofar as any features thereof affect or tend to affect the public health, and no construction shall take place except in accordance with the approved plans. A well installed or materially altered for the purpose of providing water to a noncommunity or nontransient noncommunity water supply is exempt from this part.”

### **PLANS AND SPECIFICATIONS**

Complete plans and specifications for the well and water system must be submitted to and approved by the MDH, Drinking Water Protection Section, St. Paul office prior to beginning construction of a community public water-supply well and must include:

- The name, address, and telephone number of the well owner and the well contractor;
- The street address and a legal location of the well including the county, township name, township number, range number, section number, and section quarter(s);
- A site plan with an arrow indicating the direction “North” which shows the proposed location of the well, buildings, property lines, utilities, septic tanks, drainfields, buried sewer pipes, and all other possible sources of contamination;
- A well plan giving the proposed well construction, depth of the well, drilling method, diameter and length of the casing, casing material, grouting material, pitless unit, wellhead construction, and venting provisions. Plans for new **municipal** water systems or materially altering existing systems must be signed by a licensed professional engineer (PE);
- An estimated geologic log with formation contacts and depths;
- Make, model, operating range, and location of the pressure tank(s);
- Make, model, size, and type of well pump; and
- The plan review fee for municipal-water systems. The current plan review fee for a municipal well is \$250 and \$150 for a pump house. Fees for treatment plants, watermains and other components may be found on the MDH Web site.

If you have questions on whether plan review is required for a project, or questions on well construction, please contact the MDH district hydrologist or district well inspector. If you have questions on plan review information requirements, please contact the MDH, Drinking Water Protection Section at 651-201-4700.

Plans should be submitted to:

Minnesota Department of Health  
Environmental Health Division  
Drinking Water Protection, Plan Review  
625 North Robert Street  
St. Paul, Minnesota 55155

***Subp. 2. Site approval. A licensee must not construct a well for a community water system until the site has been approved by the commissioner.***

Community well site inspections and approvals are conducted by the Source Water Protection Unit of the Drinking Water Protection Section, 651-201-4700.

***Subp. 3. Contamination sources. A well for a community water system must be located according to the distances specified in parts 4725.2150, 4725.2185, 4725.4350, and 4725.4450, but in no case less than 50 feet from a source of contamination except:***

All contamination sources identified in the rule that have an isolation distance less than 50 feet are increased to 50 feet for community wells except for the sources identified below.

***A. the minimum isolation distance is 20 feet for contamination sources listed in part 4725.4450, subpart 1, item G, subitems (2), (3), (8), (9), (11) and (12);***

(2) is a pit or unfilled space; (3) is an in-ground swimming pool; (8) is a buried non-pressurized water supply cistern or reservoir; (9) is a gravel pocket or French drain for clear water drainage; (11) is a water treatment backwash basin, reclaim basin, or surge tank, and associated piping, with a backflow protected sewer connection; and (12) is an elevator boring conforming to the rules. These require a 20-foot setback to a community well.

***B. the minimum isolation distance is 20 feet to an aboveground petroleum storage tank holding less than 1,100 gallons used for emergency pumping of a community public supply well if the petroleum storage tank is:***

- (1) located in a room or building separate from the community well; and***
- (2) is of double-wall construction with leak detection between the walls; or***
- (3) is protected with secondary containment according to part 7151.5400;***

***C. the minimum isolation distance is ten feet for contamination sources listed in part 4725.4450, subpart 1, item H, subitem (1); and***

Subitem (1) is a frost-proof yard hydrant or discharge from a frost-proof hydrant draining into the soil, a fire hydrant, or a flushing hydrant. These require a 10-foot setback to a community well.

*D. there is no minimum distance to a pipe or conduit carrying only clear water from a floor drain in a community well house to a gravel pocket or French drain.*

***Subp 4. Flood protection***

*A. The established ground surface at the well site must be at least two feet above the highest known water elevation of a lake, pond, river, stream, or other body of surface water, the waters of which at the highest level would approach to within 50 feet measured horizontally of the well.*

*B. The established ground surface must be sloped to drain away from the well and be graded to prevent the accumulation and retention of surface water within 50 feet of the well. Filling must be protected from erosion by riprap or other suitable means.*

This rule prohibits flood waters from reaching within 50 feet of a community public-supply well. This may require addition of fill to raise the land surface in a 100-foot-diameter circle around the well to an elevation of at least 2 feet above the highest flood of record. It should be noted that the elevation here is the highest flood of record, which may be a 500-year or greater flood, while the elevation of other water-supply wells is referenced to the 100-year flood.

***Subp. 5. Casing height.*** *The casing or casing extension must extend vertically at least 12 inches above the established ground surface, floor, or slab according to part 4725.2250, subpart 11.*

***Subp. 6. Casing vent.*** *Casing vents must be constructed in accordance with parts 4725.4850 and 4725.5450 and terminate a minimum of 18 inches above the established ground surface or floor of a building as specified in part 4725.2175.*

Minnesota Rules, part 4725.2175 describes the requirements for the location of a well within a building (well house).

The requirement to place the vent 12 inches above grade for regular water-supply wells is increased to 18 inches for community public wells.

***Subp. 7. Property ownership or easement required.*** *The owner of a community public water-supply well must own or legally control, through a permanent easement, the property within a 50-foot radius of the well.*

A copy of the deed or easement must be submitted to the MDH.

***Subp. 8. Radial water collectors.*** *Projection of radial water collectors must be in areas and at depths approved by the commissioner.*

*A. The exact location of caisson construction joints and porthole assemblies must be indicated on the submitted plans.*

*B. The caisson wall must be reinforced.*

*C. Procedures must be used that assure minimum vertical rise of the collectors.*

- D. The top of the caisson must be covered with a watertight floor.*
- E. Pump or other openings through the floor must have a minimum 4-inch high curbing.*
- F. Pump discharge piping must not be placed through the caisson walls.*
- G. There must be no construction joint within 15 feet of the established ground surface.*

“**Radial-water collectors**” refers to horizontal casings and screens which are jacked out of a central caisson. These type of wells are often referred to as “collector” wells or by the trade name “Ranney well.”

### **WHEN IS CONNECTION TO PUBLIC-WATER REQUIRED?**

The Minnesota Plumbing Code, part 4715.0310 requires that if a public water-supply system is accessible, the potable water distribution system must be connected to it unless otherwise permitted by the local authority. This means that a public water supply, typically a municipality, can require a property owner to connect to public water for potable purposes instead of drilling a well, unless there are special circumstances. The determination of whether the public system is accessible is made by the local authority, usually a city. Commonly, if the water main is in excess of a block away, the local authority will not require connection. However, this does vary from city to city; therefore, the water utility should be contacted. This requirement does not prohibit a property owner from drilling a well for nonpotable purposes such as irrigation or for a groundwater heat pump. However, there may be restrictions that a local government may place on use. The Minnesota Plumbing Code, Chapter 4715, is administered by the Department of Labor and Industry and the Plumbing Board.

*STAT AUTH: MS s 103I.101; 103I.111; 103I.205; 103I.221; 103I.301; 103I.401; 103I.451; 103I.501; 103I.525; 103I.531; 103I.535; 103I.541; 103I.621; 144.05; 144.12; 144.383; 157.04; 157.08; 157.09; 157.13*  
*HIST: 17 SR 2773; 33 SR 211*

**4725.5900** [Repealed, 17 SR 2773]

**4725.6000** [Repealed, 17 SR 2773]

**End  
of  
Public Wells Section**

## **4725.6050 REMEDIAL WATER-SUPPLY WELLS.**

“Remedial well,” sometimes referred to as “recovery well,” means a well used to lower a groundwater level to control or remove contamination in groundwater and excludes (1) horizontal trenches and (2) sumps or pits less than 10 feet deep. Remedial wells are a type of water-supply well. Remedial wells must be constructed to the standards of the general well and boring rules, Minnesota Rules, parts 4725.2010 through 4725.3875, the water-supply well standards of Minnesota Rules, parts 4725.4050 to 4725.5550, and the remedial well standards of this rule part, which provide some exemptions to the water-supply well requirements.

A remedial well requires a notification prior to construction.

The monitoring well rules do **not** apply to remedial wells. Flush threaded casing may **not** be used to construct a remedial well.

A remedial well must be constructed by a licensed well contractor. A monitoring well contractor or dewatering well contractor may not construct a remedial well. A person who is not licensed may place a water sampling device, including a well pump or pumping equipment, in a remedial well to obtain a water sample if the device is immediately removed after the sample is collected. Any other pump must be installed by a licensed well contractor or licensed pump contractor.

*Subpart 1. Additional requirements. In addition to the general standards in parts 4725.2010 to 4725.3875, and the standards for water-supply wells in parts 4725.4050 to 4725.5550, a remedial well must:*

*A. have spark arresters installed if petroleum products or other flammable or explosive materials are present;*

Spark arresters are devices or methods which minimize or prevent electrical sparking at a place where a circuit is made or broken. This generally refers to explosion-proof, sealed motors Class 1 or Group D.

*B. be equipped with a casing vent or collect and treat gases, if toxic or flammable gases are present; and*

If toxic or flammable gases are present, the gases must be vented to the outside atmosphere or treated.

*C. have connections protected with an air gap or back flow prevention device as specified in parts 4715.2010 to 4715.2170, if the well discharges to a sewer or surface water.*

The air gap is explained in the Minnesota Plumbing Code, part 4715.2010.

Portions of the Minnesota Plumbing Code are contained in the appendix.

A remedial well must follow the rules for Disposal of Materials in Minnesota Rules, part 4725.2975. Drilling mud, cuttings, treatment chemicals, or discharged water may contain materials that are contaminated. Information concerning proper disposal of contaminated materials may be obtained from the MPCA, telephone number - metro 651-296-6300, and outstate 800-657-3864 or their Web site at [www.pca.state.mn.us](http://www.pca.state.mn.us). Environmental releases must be reported to the Minnesota Duty Officer at 651-649-5451 or toll free at 800-422-0798.

*Subp. 2. Exemptions. A remedial well is exempt from:*

*A. the distance from contamination source requirements in parts 4725.4350, subpart 1, and 4725.4450;*

*B. the minimum protective depth requirements in part 4725.4550;*

*C. the requirement in part 4725.2250, subpart 11, to extend the casing 12 inches above the established ground surface if the remedial well is constructed according to part 4725.6850 for at-grade construction;*

A remedial well **must not terminate in a pit**, valve box, basement, manhole, or other below-grade structure. The casing must either terminate a minimum of 12 inches above-grade, or where allowed, terminate in an approved at-grade vault.

A variance, permit, or plan approval is not required to terminate a remedial well **at-grade**. However, the casing for a remedial well may terminate at-grade only on a roadway, sidewalk, driveway, or a parking area. At-grade termination is not allowed in “**green**” areas such as boulevards, lawns, or grassed areas. The requirements for at-grade termination are found in the at-grade monitoring well section in Minnesota Rules, part 4725.6850.

*D. the requirement in part 4725.4250, subpart 5, to extend the casing 20 feet below the static water level if the well screen or open hole intersects the water table, the casing terminates no more than ten feet above the static water level, and all casing installed in limestone or dolomite is grouted with neat-cement grout or cement-sand grout;*

*E. the venting requirements in part 4725.5450, except as provided in subpart 1, item B; and*

*F. the disinfection requirements in part 4725.5550 where disinfection will interfere with water quality analysis or create dangerous reactions with contaminants.*

### **REMEDIAL WELL EXEMPTION SUMMARY**

A remedial well is exempt from the requirement to:

- Follow the contamination source isolation distances (Minnesota Rules, part 4725.4450), including the distance to the ordinary high-water level of a river, pond, or lake (Minnesota Rules, part 4725.4350);
- Be cased to a depth of at least 15 feet from the established ground surface, or to terminate the gravel pack at least 15 feet below the established ground surface (Minnesota Rules, part 4725.4550);
- Extend the casing 12 inches above grade if the well is completed as an approved at-grade well;
- Extend the casing 20 feet below the static water level in limestone or dolomite bedrock;
- Vent the casing (Minnesota Rules, part 4725.5450); and

- Disinfect. The rules require disinfection of water-supply wells including remedial wells. This practice is encouraged to prevent the introduction of bacteria, including iron bacteria or other well fouling organisms. Disinfection of remedial wells will not be required if the disinfection will interfere with water quality analysis or create dangerous reactions with contaminants in the well (Minnesota Rules, part 4725.5550).

Even though remedial wells are exempt from the requirements above, it is recommended to follow the rules whenever possible.

A remedial well is **not** exempt from the building, gas pipe, electric line, and LP tank separation distances.

A remedial well may not be located in a building except for a well house.

**Subp. 3. Screen or open hole across an unconsolidated formation and bedrock contact.** A remedial well that is constructed to remove contaminants from the water surface by placing a screen or open hole across the contact of an unconsolidated formation and bedrock is exempt from the requirements of part 4725.2020, subpart 1, if the screen or open hole:

- A. intersects the water surface of an unconfined aquifer;
- B. does not penetrate a confining layer; and
- C. does not extend more than 20 feet into bedrock.

**Subp. 4. Stainless steel casing.** A remedial well may be constructed with stainless steel casing meeting ASTM Standard A312/A312M-04b, having at least ANSI Schedule 5 for welded joints, and ANSI Schedule 40 for threaded joints.

STAT AUTH: MS s 103I.101; 103I.111; 103I.205; 103I.221; 103I.301; 103I.401; 103I.451; 103I.501; 103I.525; 103I.531; 103I.535; 103I.541; 103I.621; 144.05; 144.12; 144.383; 157.04; 157.08; 157.09; 157.13

HIST: 17 SR 2773; 33 SR 211

**4725.6100** [Repealed, 17 SR 2773]



**End  
of  
Remedial Wells Section**

## **DEWATERING WELLS**

### **4725.6150 DEWATERING WELL.**

*Subpart 1. Scope. This part applies to a dewatering well as defined in Minnesota Statutes, section 103I.005, subdivision 4a. A dewatering well must be constructed, repaired, maintained, and sealed in accordance with the general standards in parts 4725.2010 to 4725.3875, and the requirements of this part. A dewatering well must not be used for a purpose other than dewatering. A dewatering well is exempt from the provisions in parts 4725.4050 to 4725.6050.*

“**Dewatering well**” means a nonpotable well used to lower groundwater levels to allow for construction or use of underground space. A dewatering well does not include:

- A well or dewatering well 25 feet or less in depth for temporary dewatering during construction;
- A well used to lower groundwater levels for control or removal of groundwater contamination; or
- A drain tile, perforated pipe, sump, or pit less than 10 feet deep, or less than 10 feet below the floor of a basement.

A dewatering well may only be used for dewatering, and may not be used for other purposes including potable supply, monitoring, remediation, irrigation, or other purposes.

Dewatering wells are **not** water-supply wells and are, therefore, not required to follow the isolation distance setbacks, minimum depth, and other standards of Minnesota Rules, parts 4725.4050 to 4725.5650.

Minnesota Rules, part 4725.1825 contains the dewatering well notification requirements. Changes to Minnesota Statutes, Chapter 103I, in 1994 eliminated the dewatering permit and in its place established a notification.

*Subp. 2. General construction requirements. A discharge from a dewatering system must not connect to a potable water system.*

The **discharged water** from a dewatering well must be disposed of and treated if necessary in accordance with applicable state and local laws. The U.S. Corps of Engineers, MPCA and DNR should be consulted about discharge to navigable or public waters. Local governments, including watershed districts, may have jurisdiction over discharge, including discharge to sewers.

Water taken from a dewatering well may not be provided to any private or public water system.

*Subp. 3. At-grade dewatering wells. A dewatering well cased and completed at-grade must conform to part 4725.6850.*

At-grade dewatering wells must conform to the at-grade monitoring well specifications.

**Subp. 4. Loss of potable supply.** A licensee who installs a dewatering well that causes the loss of an adequate private potable water supply must provide the private well owner with a temporary supply of potable water during the operation of the dewatering well. The supply must be adequate for drinking, cooking, and other household uses. The commissioner may require the private well to be tested to determine if a health risk exists before the licensee discontinues an alternate water supply. The licensee must assure that the required testing is completed and reported to the commissioner.

The notification requirements of Minnesota Rules, part 4725.1825 require the dewatering contractor to indicate on the notification whether the dewatering project will affect potable wells.

The DNR should be contacted regarding well interference issues involving appropriation permits.

**Subp. 5. Sealing.** A dewatering well that is not in use must be sealed according to this chapter.

The sealing procedures are detailed in Minnesota Rules, part 4725.3850.

**Subp. 6. Exceptions.** A dewatering well in an unconsolidated formation installed for less than 18 months and less than 50 feet in depth may be constructed and sealed in accordance with the conditions and exemptions in items A to E.

A. Casing is not required to meet the standards of parts 4725.2350 to part 46725.2650, if the casing is water tight, free of oil or other contaminants, and withstands the forces exerted on it during installation and removal.

This allows the use of nonstandard casing. However, the contractor is responsible for failure of substandard casing including remediation of contamination allowed by the casing, or removal and proper grouting of collapsed casing.

B. The upper termination of the casing must be covered with a tamper-resistant overlapping cover on the casing as specified in part 4725.2250, subpart 17. The casing is not required to terminate at least 12 inches above the established ground surface if the casing extends at least 12 inches above the working grade. The working grade is the temporary elevation of the ground surface during a construction project.

C. The gravel pack must not extend more than ten feet above the static water level.

D. The annular space is not required to be grouted to depth of 50 feet in accordance with part 4725.3050, subpart 3, if the annular space is filled with cuttings taken from the bore hole.

The annular space around the casing must be completely filled with grout or cuttings. The cuttings may be shoveled into the space so as to prevent bridging.

*E. At 18 months after construction or sooner, the well must be sealed according to this chapter. A dewatering well installed for 18 months or less, not encountering a confining layer, less than 50 feet in depth, completed in an unconsolidated formation, and that is not flowing, may be sealed according to part 4725.7450, subpart 4.*

Minnesota Rules, part 4725.7450 allows sealing of certain environmental bore holes by removing the casing and screen allowing the hole to collapse. Certain dewatering wells may also be **allowed to collapse only** under the following conditions:

- The well must be less than 50 feet deep;
- The well must be completed only in an unconsolidated formation;
- The well must not encounter pollution; and
- The collapse must not be induced.

The remaining portion of the hole above the collapse must be grouted from the bottom to the top with cement or bentonite grout.

*Subp. 7. **Special construction areas.** The commissioner may require additional construction standards in special well and boring construction areas as described in part 4725.3650.*

*STAT AUTH: MS s 103I.101; 103I.111; 103I.205; 103I.221; 103I.301; 103I.401; 103I.451; 103I.501; 103I.525; 103I.531; 103I.535; 103I.541; 103I.621; 144.05; 144.12; 144.122; 144.383; 157.04; 157.08; 157.09; 157.13*

*HIST: 17 SR 2773; 18 SR 1222; 33 SR 211*

**4725.6200** [Repealed, 17 SR 2773]

**4725.6300** [Repealed, 17 SR 2773]

**4725.6400** [Repealed, 17 SR 2773]

**End  
of  
Dewatering Wells Section**

## **MONITORING WELLS**

A “**monitoring well**” is an excavation that is drilled, cored, bored, washed, driven, dug, jetted, or otherwise constructed to extract groundwater for physical, chemical, or biological testing. Any excavation, regardless of the method of construction, depth, depth or lack of casing, or length of time the excavation is used, is a monitoring well if the excavation is constructed to remove one or more samples of groundwater for testing.

A monitoring well must be constructed by a registered monitoring well contractor or licensed well contractor.

A permit is required prior to the construction of a monitoring well except for monitoring wells sealed within 72 hours of the start of construction. The permit requirements are located in Minnesota Rules, part 4725.1830.

### **4725.6450 APPLICABILITY AND USE.**

*This part applies to monitoring wells as defined in Minnesota Statutes, section 103I.005, subdivision 14.*

*In addition to the general construction, repair, maintenance, and sealing requirements in parts 4725.2010 to 4725.3875, a monitoring well must be constructed, repaired, maintained and sealed in accordance with this part. A monitoring well is exempt from the requirements in parts 4725.4050 to 4725.6050.*

*A monitoring well that is not in use must be sealed.*

A monitoring well is “in use” if it is sampled on a scheduled basis.

*STAT AUTH: MS s 103I.101; 103I.111; 103I.205; 103I.221; 103I.301; 103I.401; 103I.451; 103I.501; 103I.525; 103I.531; 103I.535; 103I.541; 103I.621; 144.05; 144.12; 144.122; 144.383; 157.04; 157.08; 157.09; 157.13*

*HIST: 17 SR 2773; 18 SR 1222; 33 SR 211*

**4725.6500** [Repealed, 17 SR 2773]

**4725.6600** [Repealed, 17 SR 2773]

### **4725.6650 CONSTRUCTION OF MONITORING WELLS.**

*Subpart 1. Casing. Casing for a monitoring well must be steel or plastic casing meeting the standards of parts 4725.2250 to 4725.2650, or stainless steel or flush threaded polyvinyl chloride meeting the standards of this subpart.*

*A. A monitoring well may be constructed with flush threaded polyvinyl chloride (PVC) casing if:*

*(1) the screen intersects the surface of the water table at the time of installation and the well is constructed so the joint between the two deepest casing sections is above the surface of the water;*

*(2) the total depth of the monitoring well is 50 feet or less;*

*(3) the monitoring well is completed in unconsolidated materials; and*

*(4) the flush threaded PVC casing used meets the standards of ASTM F480-02, and the standards in Schedule 40 as referenced in ASTM Standard D1785-04.*

### **FLUSH THREADED CASING**

- Flush-threaded casing may be used only in **water-table** (unconfined) aquifers. Flush threaded casing may not be used below a perched aquifer.
- The 50-foot distance refers to the maximum depth of the bore hole including casing, screen, and gravel pack below the screen.
- The **entire** well casing, screen, and gravel pack must be completed in unconsolidated materials. Flush threaded casing must not be used in a well completed in bedrock.
- Flush threaded casing may only be used for monitoring wells and environmental bore holes under these conditions. It may not be used for other types of wells or borings such as remedial wells, and may not be used under conditions other than those in (1) through (4) above.
- The 2008 revisions required for the first time that flush threaded casing meet the ASTM F480 standard. This standard has been required for solvent-welded plastic casing since 1978.
- It is recommended to use casing which meets ANSI/NSF Standard 61-2003e or the health effects portion of ANSI/NSF Standard 14-2003. This provides some assurance that chemicals will not leach from the casing and affect the water quality.

*B. A monitoring well may be constructed with stainless steel casing meeting ASTM Standard A312/A312M-04b, having at least ANSI Schedule 5 for welded joints and ANSI Schedule 40 for threaded joints.*

### **REQUIRED MARKINGS ON STAINLESS STEEL PIPE**

American Society for Testing and Materials (ASTM)  
STANDARD A312-86a

Pipe manufactured in conformance with this specification shall be marked with the following information:

1. The manufacturer's name or brand;
2. The manufacturer's private identifying mark;
3. Identification of seamless or welded;
4. The specification number and grade; for grades TP304H, TP316H, TP321H, TP347H, TP348H, and S30815; the marking shall also include the heat number and heat treatment lot identification; and
5. Pipe larger than NPS 4 shall include the weight.

Marking shall begin approximately 12 inches from the end of each length of pipe. For pipe less than NPS 2 and pipe under 3 feet in length, the pipe's required information may be marked on a tag securely attached to the bundle or box in which the pipes are shipped.

A table of ANSI pipe schedules is included in the appendix.

**Subp. 2. Grouting of annular space.** *The annular space of a monitoring well must be grouted from ten feet or less above the screen or open bore hole to the established ground surface according to part 4725.3050, except that no cuttings from the bore hole must be added to the grout. Neat-cement or cement-sand grout may terminate at the base of the manhole or vault for an at-grade installation.*

The grouting requirement applies to all monitoring wells constructed by a method which creates an annular space (auger, rotary, etc.). Casing may be driven if the driven casing is installed in accordance with Minnesota Rules, part 4725.3050.

Unlike other wells and borings, **cuttings may not be used** to grout a monitoring well or cased environmental bore hole.

The provision to allow neat-cement or cement-sand grout to terminate 6 inches below a vault or manhole is to prevent frost damage to the well and vault.

**Bentonite chips** may be used in place of bentonite pellets as an intermediate seal between a gravel pack and the grout. It should be noted that this is the only permitted use of bentonite pellets or chips. Chips or pellets may not be used to seal or grout a well or boring.

Grout must not be poured; it must be emplaced through a tremie pipe, except where the depth of the space to be grouted is 10 feet or less.

**Subp. 3. Exception to drilling fluids.** *Drilling fluids used to construct a monitoring well must comply with part 4725.2950, except that a free chlorine residual is not required.*

Monitoring wells may be constructed with drilling water which does not contain a free chlorine residual and the wells do not have to be disinfected upon completion. However, bacteria, including iron or other slime-producing bacteria, are usually introduced into a well when constructed. These bacteria can lead to erroneous water quality results, bio-fouling of the well, and decreased well life. Disinfection can greatly reduce these problems.

**Subp 4. Screen or open hole across an unconsolidated formation and bedrock contact.** *A monitoring well, that is constructed to monitor contaminants at the water surface, by placing a screen or open hole across the contact of an unconsolidated formation and bedrock according to part 4725.6050, subpart 3, is exempt from part 4725.2020, subpart 1.*

*STAT AUTH: MS s 103I.101; 103I.111; 103I.205; 103I.221; 103I.301; 103I.401; 103I.451; 103I.501; 103I.525; 103I.531; 103I.535; 103I.541; 103I.621; 144.05; 144.12; 144.122; 144.383; 157.04; 157.08; 157.09; 157.13*

*HIST: 17 SR 2773; 18 SR 1222; 33 SR 211*



**4725.6700 [Repealed, 17 SR 2773]**

**4725.6750 [Repealed, 17 SR 2773]**

**4725.6755 PROTECTION OF MONITORING WELLS.**

*Subpart 1. Casing, protective casing, and capping. The inner casing of a monitoring well, and when installed, the protective outer casing as specified in subpart 2, item B, with bentonite grout in the annular space, must be covered with a cap or cover in accordance with part 4725.2250, subpart 17. The protective outer casing may be covered with an overlapping cap or cover without a compression gasket.*

Both the casing and the protective casing must be capped or covered in accordance with Minnesota Rules, part 4725.3150, which requires a weatherproof and insect proof threaded connection, welded connection, rubber expansion sealer, bolted flange with rubber gasket, overlapping cap with compression gasket, or pump. Either the protective casing (“pro-top”) or the casing (“riser”), but not necessarily both, must be secured with a tamper-proof closure consisting of a locked cap, or wrench-tightened, threaded metal cap. The casing must be covered with a watertight cap. “J”-plug type compression seals are allowed.

A monitoring well is not required to be **vented** but may be vented if desired. Vents must comply with the water supply venting requirements of part 4725.5450. The practice of drilling a hole in the casing or cap to vent the well is not approved.

*A. Either the inner casing, or the protective outer casing must be closed with a watertight, locked cap or a wrench-tightened, threaded metal cap.*

Either the casing or the outer protective casing must have a locked or threaded metal cap; it is not required that both caps be metal.

*B. The top of the well must be constructed to prevent entry of flood waters according to part 4725.4350, subpart 2.*

These requirements apply only to monitoring wells and cased environmental bore holes located within the designated 100-year flood plain.

The requirements in this subpart do not apply to a well located in an area protected by a flood control structure accepted by the United States FEMA, as designated on a FEMA flood map

The “**regional flood level**” is the 100-year flood level. “Regional flood level” is defined in Minnesota Statutes, section 103F.111, subdivision 10, to mean a flood that is representative of large floods known to have occurred generally in the state and reasonably characteristic of what can be expected to occur on an average frequency in the magnitude of a 100-year-recurrence interval. The regional flood is often referred to as the “100-year flood.”

Minnesota Rules, part 4725.4350, subpart 2 requires:

- A. Extending the casing at least 5 feet above the regional flood level. Wells may also be completed by installing a casing coupling 2 feet above the ground surface and extending the casing 5 feet above the regional flood level. The casing extension may be removed for service. Pump wires may exit the casing immediately below the coupling through a watertight connection;
- B. Installing a watertight seal and extending the casing 10 feet above the established ground surface, if the regional flood level is more than 5 feet above the established ground surface;
- C. Installing an outer, neat-cement grouted protective casing in accordance with Minnesota Rules, part 4725.6755 subpart 2, item B, extending the protective casing and well casing a minimum of 2 feet above the established ground surface, and installing a waterproof threaded cap or a waterproof compression seal with drawbolts and a one-piece top plate on both casings. At-grade installations are permitted when equipped with a waterproof vault and cap. Overlapping, nonthreaded caps; O-ring seals; and nontapered threads, such as flush threads, are not permitted; or
- D. Extending the casing a minimum of 2 feet above the established ground surface, installing a sealed spool, or flowing well pitless unit, and installing a waterproof, nonvented compression seal with drawbolt(s) and a compression gasket. Electrical wires must exit through a watertight compression fitting. Packers or drawdown seals are not equivalent protection.

*C. A monitoring well cased with plastic must be protected with an outer steel protective casing as specified in subpart 2, item B.*

Subpart 2, item B requires an outer, steel-protective casing. There are two exceptions to this requirement:

- This requirement does not apply to at-grade wells.
- A plastic casing may be protected by a concrete pyramid as described in subpart 2, item A if the pyramid incorporates a Schedule 40 steel outer protective casing. Using this method, the steel casing does not have to extend 4 feet below ground; instead it must extend at least to the base of the pyramid.

Three posts are not equivalent to the grouted, protective casing or pyramid for plastic casing.

The options for capping are found in Minnesota Rules, part 4725.3150, and include a weatherproof and insect proof threaded connection, welded connection, rubber expansion sealer, bolted flange with rubber gasket, overlapping cap with compression gasket, or pump.

***Subp. 2. Protection. A monitoring well must be protected by:***

Every monitoring well (except at-grade wells) must be protected by one of three methods: concrete pyramid, steel outer casing, or three posts. A diagram of the three methods follows item "C."

*A. surrounding the casing with a concrete pyramid or cone that has horizontal dimensions of at least 24 inches by 24 inches at the established ground surface, that rises 12 inches above the established ground surface at the casing, and has a base with a mass of at least three cubic feet below the established ground surface;*

*B. installing a steel outer casing meeting the material standards of part 4725.2350 that is at least 3.0 inches in diameter greater than the inner casing, that extends at least two feet above and four feet below the established ground surface, and that has bentonite grout, neat-cement grout, or cement-sand grout in the annular space between the casings from the bottom of the outer casing to the established ground surface; or*

*C. placing three posts at least four inches square or four inches in diameter around the well at equal distances from each other and two feet from the casing. The posts must extend two feet above and four feet below the established ground surface or to a depth of two feet if each post is set in concrete to a depth of two feet. The posts must be made of reinforced concrete, decay-resistant wood, or ASTM Schedule 40 steel pipe capped with an overlapping, threaded, welded steel or iron cap, or be filled with cement.*

Standard dimension 4 x 4's (which measure 3-1/2" x 3-1/2" inches) are acceptable.

*STAT AUTH: MS s 103I.101; 103I.111; 103I.205; 103I.221; 103I.301; 103I.401; 103I.451; 103I.501; 103I.525; 103I.531; 103I.535; 103I.541; 103I.621; 144.05; 144.12; 144.383; 157.04; 157.08; 157.09; 157.13*  
*HIST: 17 SR 2773; 33 SR 211*

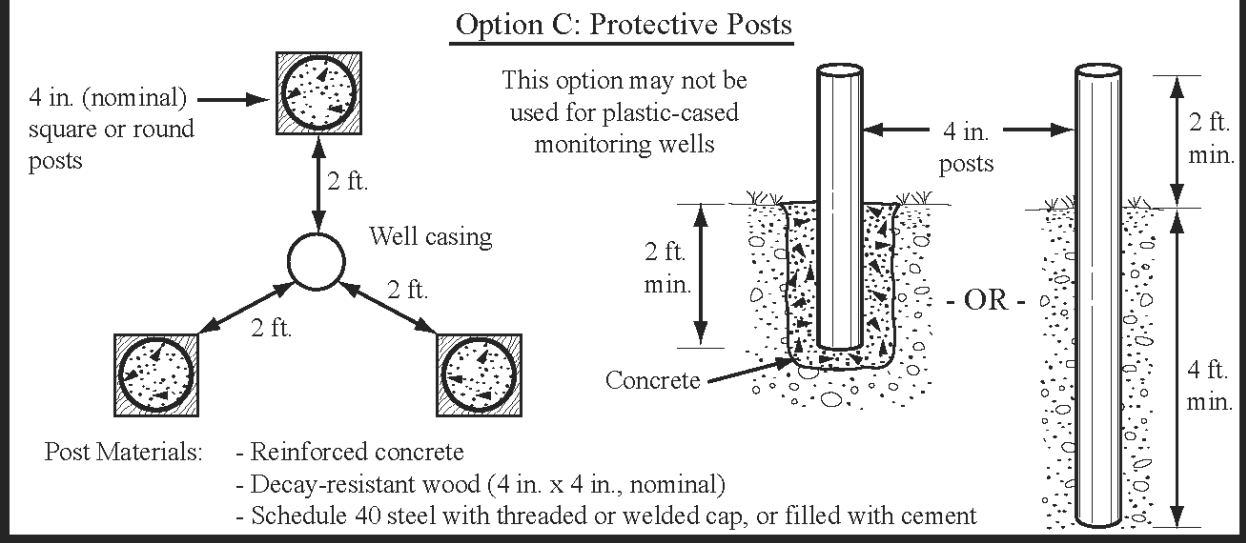
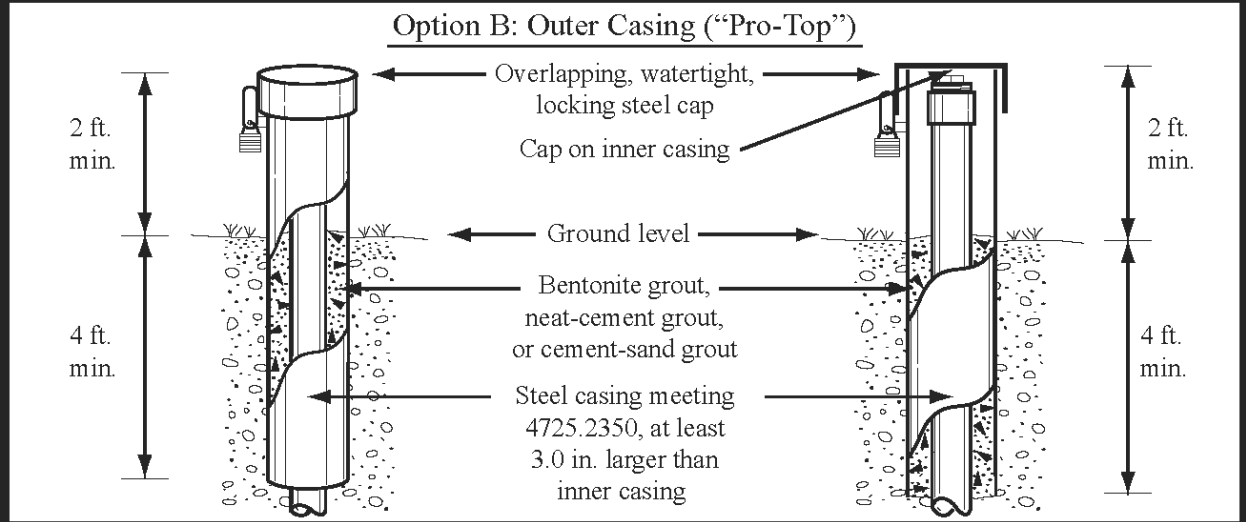
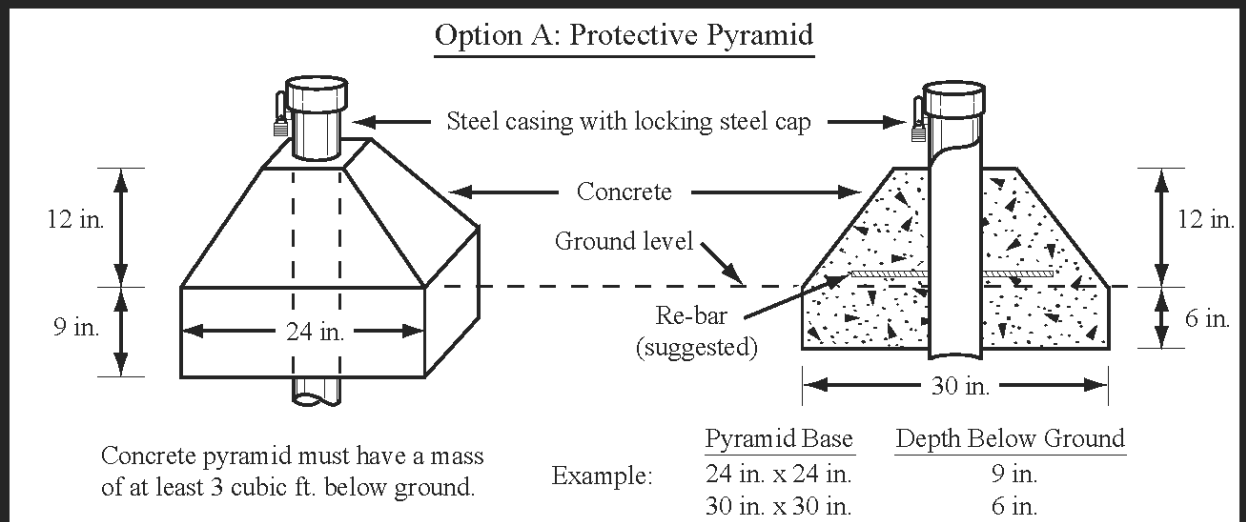

Figure 28. Protection Options For Monitoring Wells

### **4725.6775 REPAIR; SEALING OF MONITORING WELL.**

*A monitoring well owner must repair or seal a damaged monitoring well within seven days after the property owner becomes aware of the damage.*

The property owner is responsible for well repair and sealing unless a written agreement exists between the property owner and well owner in accordance with Minnesota Statutes, section 103I.205, subdivision 8, and Minnesota Rules, part 4725.1830, item D. The requirements for well repair are found in Minnesota Rules, part 4725.3750.

*STAT AUTH: MS s 103I.101; 103I.221; 103I.301; 103I.621; 144.05; 144.12; 144.383; 157.04; 157.08; 157.09; 157.13*

*HIST: 17 SR 2773*

**4725.6800 [Repealed, 17 SR 2773]**

### **4725.6850 AT-GRADE MONITORING WELL.**

*Subpart 1. At-grade termination. A monitoring well must terminate at least 12 inches above the established ground surface unless the commissioner determines that no location exists for such a well to provide monitoring information equivalent to an at-grade well.*

A **permit** must be submitted and approved prior to constructing a monitoring well or converting an existing monitoring well to at-grade. The permit application for an at-grade well must contain a map showing the location of the at-grade well and providing documentation as to why the well cannot be completed above-grade and as to the traffic hazard presented by an above-grade completion.

Monitoring wells may terminate at-grade in flood areas subject to the conditions detailed in Minnesota Rules, part 4725.6755.

*Subp. 2. Termination location; map. A monitoring well casing may terminate at-grade only on a roadway, sidewalk, driveway, or a parking area. The location of the well identified by unique well number must be marked on a scaled map with angles and directions from surveyed property corners, a permanent benchmark, or the corners of a permanent structure. The map must be submitted to the commissioner with the well record*

At-grade wells are allowed **only on areas with vehicular traffic**. This includes paved or gravel roads with vehicle traffic, ramps or sidewalks with wheelchair traffic, or airport runways or taxiways, where termination of the casing above-grade creates a safety hazard that cannot be mitigated. At-grade wells are not allowed at locations which do not have vehicular traffic such as grassed or “green” areas like boulevards or lawns. At-grade termination may be allowed by variance in situations such as athletic playing fields, or on certain rights-of-way where above grade termination presents a safety hazard.

Minnesota Statutes, section 219.50, prohibits obstructions within 8-1/2 feet of the center line of a railroad track. At-grade monitoring well, remedial well, environmental bore hole, and dewatering well casing termination will be allowed within 8-1/2 feet of the track center line without a variance.

The at-grade well location map must be submitted with the well construction record. It is not required to survey the location, but it is required to provide accurate measurements of the well location in relation to permanent landmarks.

***Subp. 3. Construction. An at-grade monitoring well must be constructed as specified in this subpart.***

***A. At-grade well casing must terminate no lower than the established ground surface.***

As indicated in the diagrams below, the casing must terminate no lower than “at” or flush with grade, not in a pit, or below ground level. The top of the manhole or vault must be raised at least 2 inches above the surrounding grade.

***B. The well must be contained in a protective manhole cover or vault. The top of the manhole cover or vault must be no less than two inches above the established ground surface.***

A list of manholes and vaults meeting the standards of these rules is included in the appendix of approved materials.

***C. The established ground surface must be sloped to divert surface water or spills away from the well and to allow for traffic movement and snow plowing.***

***D. The manhole cover or vault must be installed in a concrete pad at least four inches in thickness and four feet square or four feet in diameter and of sufficient load-bearing capacity to support vehicular traffic.***

Asphalt, gravel, or materials other than concrete are not allowed to support the vault. A precast concrete pad may be installed, but the pad must be firmly bedded.

The top of the concrete pad must be sloped away from the well in all directions. If the well is installed on sloping ground, the pad is not required to be level, but can be sloped to match the slope of the surrounding grade.

If the well will be located in an existing concrete surface, a 4-foot section of the existing concrete must be removed in order to slope the pad away from the well in all directions. If the existing concrete has adequate drainage, a variance may be applied for to cut a smaller hole and support the vault by use of a flange, cemented pins, or other means.

*E. The manhole cover or vault must be labeled with the words “Monitoring Well” cast or stamped in letters at least one centimeter or one-half inch in height.*

The triangular symbol denoting “monitoring well” is not equivalent to the words “monitoring well.” At-grade installations for environmental bore holes, remedial wells, or dewatering wells must also be marked, either with a standard vault marked “monitoring well” or preferably permanently marked denoting the type of well or boring. The marking may be factory cast, stamped with a die into the cap or flange, stamped on a metal plate attached to the cap or flange, or marked with a weld bead.

*F. All materials used to construct the manhole cover or vault must be resistant and impervious to water, petroleum products, and chemicals likely to be present.*

*G. The manhole cover or vault must have a watertight, impervious compression O-ring or gasket.*

*H. The manhole cover or vault must meet AASHTO Standards H20-44 and M306-04.*

*I. The well casing must be secured with a locking cap or cover according to part 4725.2250, subpart 17. The manhole cover or vault must be secured with a lock or tamper-resistant bolts.*

The well casing must have a key or combination lock. A threaded cap or bolted cap is not sufficient.

*J. The well label must be placed on the well casing, manhole cover, or vault, or the unique well number may be stamped on the vault.*

### **COMPLETION OF AT-GRADE VAULTS IN WINTER**

Contractors have requested that the MDH allow postponement of pouring at-grade protective pads during subfreezing weather. Concerns for vehicular damage to the well, paving over or burying of the well, or runoff into the well has led the department to deny these requests. The protective pad, vault, and watertight seals must be installed upon completion of drilling and before the well is used.

Options for legally completing at-grade wells in subfreezing weather include:

- Use of concrete accelerators, thermal blankets, heated enclosures;
- Replacement of frozen fill;
- Use of a precast pad;
- Postponement of drilling until warmer weather; or
- Completion of the well above-grade until warmer weather.

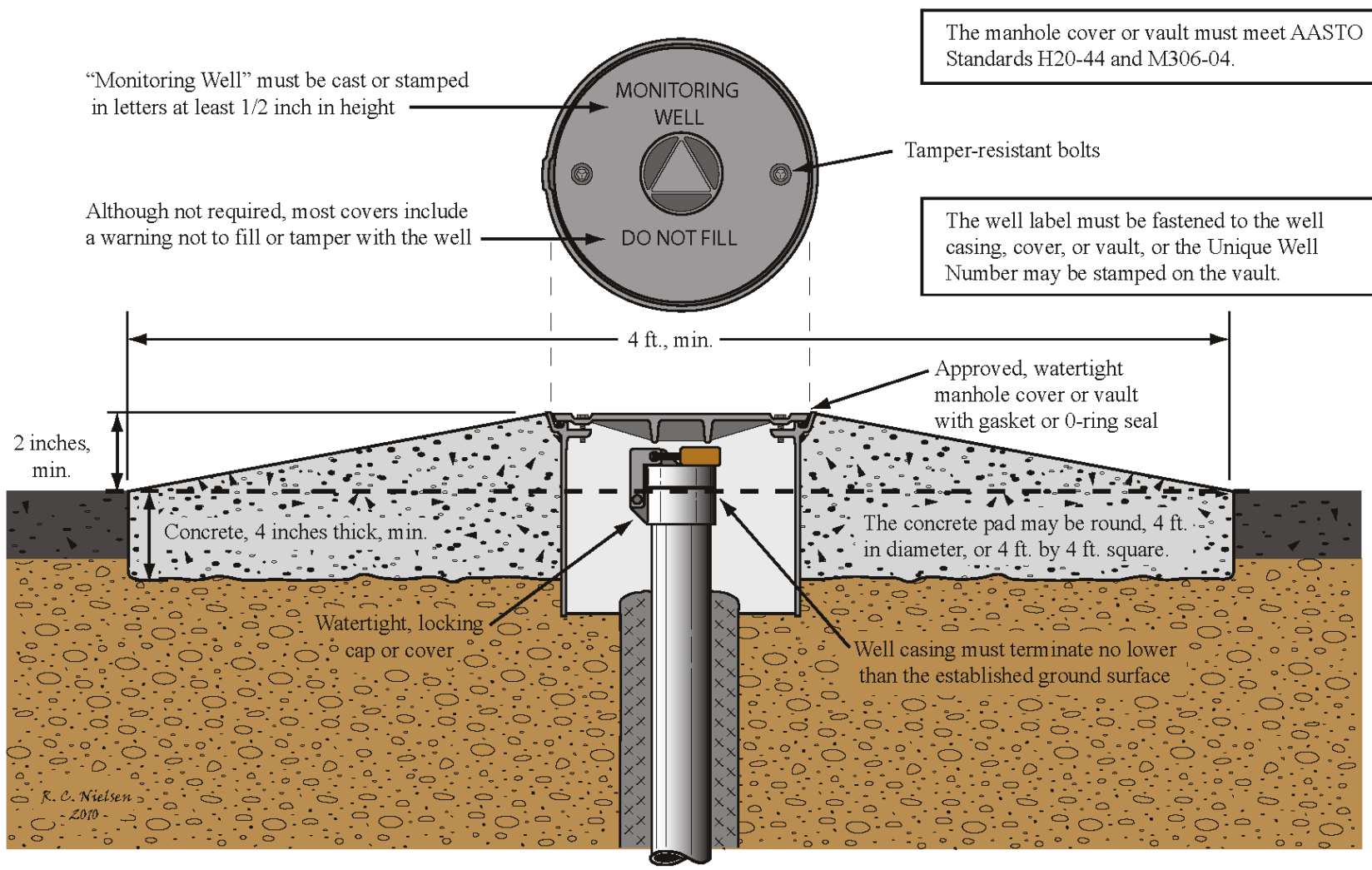

Figure 29. Construction Requirements for At-Grade Monitoring Wells



*STAT AUTH: MS s 103I.101; 103I.111; 103I.205; 103I.221; 103I.301; 103I.401; 103I.451; 103I.501; 103I.525; 103I.531; 103I.535; 103I.541; 103I.621; 144.05; 144.12; 144.383; 157.04; 157.08; 157.09; 157.13*

*HIST: 17 SR 2773; 33 SR 211*

**4725.6900** *[Repealed, 17 SR 2773]*

**4725.7000** *[Repealed, 17 SR 2773]*

## **VERTICAL HEAT EXCHANGERS**

### **4725.7050 VERTICAL HEAT EXCHANGERS.**

A “**vertical heat exchanger**” may also be referred to as a vertical loop, heat loop, geothermal loop, closed loop, earth-coupled loop, ground loop, or earth loop. Vertical heat exchangers are a type of boring used to extract heat from the ground, or dispose of heat in the ground, usually to heat or cool a home, school, business, or other building. A typical system consists of two 3/4 to 1-1/4-inch plastic pipes with a “U”-shaped connection at the bottom (a supply and a return line) installed in a hole in the ground, and a pump to force heat exchange fluid (special antifreeze) through the loop to a compressor where the heat from the ground is removed from the fluid and used for space heating; or the heat from a building is transferred to the fluid and ultimately to the ground in order to cool the building.

This rule part regulates the construction of vertical heat exchangers. The rules do not regulate the construction of **horizontal heat exchangers** (piping installed horizontally in soil trenches or in coils in the ground or in lakes or ponds). However, the rules do require an isolation distance between a water-supply well and a horizontal, “slinky,” or pond heat exchanger piping containing a contaminant.

When installing or constructing a vertical heat exchanger, the materials and methods must comply with the provisions below and in Minnesota Rules, parts 4725.2010 to 4725.3950. The bore holes must comply with the electric line, gas pipe, and LP tank isolation distances as well as the 3-foot building and building overhang separation. The bore holes are prohibited from being in or under a building. The bore holes are not required to be separated from sources of contamination as specified in Minnesota Rules, parts 4725.4350 and 4725.4450 (the isolation or “setback” distances do not apply between a vertical heat exchanger and a source of contamination). Vertical heat exchanger bore holes must be 35 feet from a water-supply well. Horizontal piping from a vertical heat exchanger (using approved propylene glycol) must be no less than 10 feet from a water-supply well. Horizontal heat exchangers using other heat transfer fluids such as ethanol or methanol must be 50 feet from a water-supply well.

The vertical heat exchanger construction permit requirements are located in Minnesota Rules, part 4725.1833.

***Subpart 1. Construction. A vertical heat exchanger must be constructed according to the general construction standards in parts 4725.2010 to 4725.3875 and the provisions in this part.***

***A. Vertical heat exchanger piping must be a minimum 160 psi pressure-rated, SDR 11 high density polyethylene, meeting ASTM Standard D3035-03a.***

This refers to the piping installed vertically in the ground. This material standard does not apply to the horizontal piping used to manifold the loops together; however, if this quality of piping is used, the setback to a water-supply well is 10 feet. If other materials are used, the setback is 50 feet.

ASTM Standard D3035-03a requires that the pipe must be marked in intervals of not less than every 5 feet with the following: the nominal pipe size, type of plastic material, dimension ratio (SDR 11), pressure rating at 73 degrees F (160 psi), “ASTM D 3035”, and the manufacturer’s name or trademark and code.

***B. Connections to vertical heat exchanger piping must use socket fusion or butt fusion joining methods.***

Socket fusion and butt fusion are joining techniques where the pipe ends are heated in a special fusing machine, softened, pressed together, and fused forming a joint that is as strong as or stronger than the original pipe. Some manufacturers provide training. All other joining techniques, such as solvent welding and the use of mechanical fasteners, are not allowed.

***C. Vertical heat exchanger piping must be pressure tested with air or potable water for 15 minutes at a pressure of 1.5 times the system operating pressure or 75 pounds per square inch, whichever is greater, after installation in the bore hole.***

After each loop is installed vertically in the ground and before the piping is filled with heat-transfer fluid, the loop must be filled with air or potable water and pressurized to a minimum of 1.5 times the maximum operating pressure or 75 pounds per square inch, whichever is greater. Loops which fail to hold the pressure must be removed and repaired by socket-fusion or butt-fusion joining, replaced, or properly sealed.

The Minnesota Mechanical Code, Minnesota Rules, Chapter 1346, adopts the 2006 International Mechanical Code which requires a pressure test of assembled ground source mechanical systems (geothermal), and a flow and pressure loss test of the system. Persons contracting to do mechanical work in Minnesota (not including the vertical loop itself) must have a \$25,000 mechanical bond under Minnesota Statutes, section 326B.197. For further information contact DLI.

***D. The annular space between the vertical heat exchanger piping and the bore hole must be grouted with neat-cement grout or cement-sand grout in bedrock, and neat-cement grout, cement-sand grout, thermally enhanced bentonite grout, or bentonite grout in unconsolidated materials according to the procedures in part 4725.3050, subpart 2. Thermally enhanced bentonite grout must consist of a fluid mixture of not more than 17.5 gallons of water, not more than 200 pounds of sand with 80 percent or more of the sand smaller than 0.0117 inch (passing U.S. Sieve #50), and a minimum of 50 pounds of bentonite.***

Minnesota Rules, part 4725.3050, subpart 2, relates to grouting methods. Vertical heat exchangers must be entirely grouted from the bottom of the drilled hole to the land surface. Unlike water-supply wells, the annular space below 50 feet may **not** be filled with cuttings; it must be grouted. Grout must be pumped through a tremie pipe that has been inserted to the bottom of the bore hole and grouted from the bottom up. Drill rods may be used to pump grout. When grouting in rock, neat-cement or cement-sand grout must be used. When grouting in unconsolidated materials such as glacial drift, neat-cement grout, cement-sand grout, thermally enhanced bentonite, or bentonite grout must be used. Grout not only protects the groundwater, but an ungrouted hole has poor thermal transfer and leads to a system that is very inefficient.

The rules do not allow for greater amounts of sand than a 1:1 mixture of sand and Portland cement for cement-sand grout, a 1:1 mixture of sand and bentonite for bentonite grout; or a 4:1 mixture of sand and bentonite for thermally enhanced bentonite grout.

The sand used for the 1:1 mixture in cement-sand grout or bentonite grout is not required to meet any specific sand size ratio or analysis, other than the sand must be sand-sized. However, contractors have reported that the finer-grained sand required in the thermally enhanced bentonite grout pumps easier and does not separate or settle as much as coarser sand. Sand used in a thermally enhanced bentonite grout (4 parts sand to 1 part bentonite) must

meet the criteria in the rule above. This finer-grained sand (smaller than a Number 50 sieve) provides lower permeability and higher thermal transfer compared to coarser-grained sands.

Because of the rapidly evolving geothermal industry, variances may be considered when the grout or other material can be demonstrated to provide protection equivalent to that required in rule.

*E. Only food-grade or USP-grade propylene glycol must be used as heat transfer fluid. No other materials or additives must be used except for potable water. A permanent sign must be attached to the heat pump specifying that only approved heat transfer fluids must be used.*

Propylene glycol is commonly sold as recreational vehicle (RV) antifreeze. RV antifreeze is not normally food grade meeting the standards of the United States Department of Agriculture, nor USP (United States Pharmacopoeia) grade. The product must not be used unless it is marked to meet one of these standards. A permanent sign must be attached to the heat pump specifying that only approved heat transfer fluids must be used.

The MDH has approved some propylene glycol products designed for geothermal applications that contain small quantities of chemicals other than propylene glycol. Check the Geothermal section near the back of this handbook, the MDH Well Management Section Web site, or the Well Management News newsletter for current information.

*F. Water make-up lines to the vertical heat exchanger must be protected with backflow prevention in accordance with parts 4715.2010 to 4715.2170.*

Part 4715.2110 of the Minnesota Plumbing Code relates to backflow prevention devices required where an air gap cannot be provided. Backflow prevention devices are explained in Minnesota Rules, part 4725.3350 and in the appendix.

For vertical heat-exchange systems connected to water make-up lines, a RPZ-type backflow preventer is required because of the continuous pressure and existence of a high-hazard cross connection. A reduced pressure zone-type backflow preventer consists of two independent check valves with an intermediate relief valve. It also contains shut-off valves and ball-type test ports. RPZ's are subject to the licensing, installation, maintenance and testing requirements of the Minnesota Plumbing Code, Minnesota Rules, Chapter 4715.

*G. A vertical heat exchanger constructed according to this part must be no less than 35 feet from a water-supply well. The horizontal piping must be no less than ten feet from a water-supply well.*

Water-supply wells include public and private drinking water wells, irrigations wells, commercial supply wells, and others.

The DLI and the Minnesota Plumbing Board regulate plumbing through the Minnesota Plumbing Code, Minnesota Rules, Chapter 4715. The Plumbing Code requires that a source of pollution be a minimum of 10 feet from a potable water service pipe. The DLI considers geothermal piping containing antifreeze, including propylene glycol, to be a source of pollution that must comply with the 10-foot setback.

Horizontal heat exchangers must also be setback from water-supply wells. A 10-foot distance is required if the fluid is propylene glycol and the piping is high density polyethylene meeting the standards of these rules. If the fluid or piping does not meet the standards a 50-foot setback is required.

***Subp. 2. Notice of loss or leak. The owner of the vertical heat exchanger must notify the commissioner of heat loop leakage or loss of pressure within 24 hours after the owner becomes aware of the loss or leak.***

***STAT AUTH: MS s 103I.101; 103I.111; 103I.205; 103I.221; 103I.301; 103I.401; 103I.451; 103I.501; 103I.525; 103I.531; 103I.535; 103I.541; 103I.621; 144.05; 144.12; 144.383; 157.04; 157.08; 157.09; 157.13***

***HIST: 17 SR 2773; 33 SR 211***

***4725.7100 [Repealed, 17 SR 2773]***

***4725.7200 [Repealed, 17 SR 2773]***

## **ELEVATOR BORINGS**

### **4725.7250 ELEVATOR BORINGS.**

The rules regulate the construction of an excavation for the installation of an elevator hydraulic cylinder, sometimes referred to as a “jack hole,” or “elevator jack.” The rules do not regulate the construction of the elevator car, the shaft the car operates in, cable elevators, or hydraulic jack holes for purposes other than elevators such as car lifts at automobile service stations. The well and boring rules also do not regulate “holeless” or “limited access” elevators where the depth of the hydraulic cylinder and pit is 10 feet or less.

In addition to MDH regulation of elevator borings, some aspects of elevators are regulated by the DLI.

*Subpart 1. General. An elevator boring must be constructed according to the general construction standards in parts 4725.2010 to 4725.3875 and cased, sealed, and maintained according to this chapter to prevent the vertical movement of water.*

*Subp. 2. Casing. The boring must be cased to the bottom of the excavation.*

In order to contain hydraulic fluid leakage, the rules require two things: first, that the hole is cased the entire length; and second, that protective measures be taken to prevent fluid loss to the ground (the requirements of subpart 4). Unlike water-supply wells, the casing must extend to the bottom of the bore hole. While it is not specifically required, this will typically result in rock holes having at least two casings: a surface casing to rock, and an inner casing to the bottom. The casings must follow the inner/outer casing combination requirements of Minnesota Rules, part 4725.2250 (3.0-inch or 3.5-inch size difference). The annular space between the casings must be grouted with neat-cement or sand-cement grout.

*Subp. 3. Exception. The boring is exempt from the requirements in parts 4725.2150; 4725.2175; 4725.2185; 4725.2250, subpart 8, concerning extension of the casing 12 inches above the established ground surface; and 4725.2250, subpart 11.*

An **elevator boring** is **exempt** from:

- The required separation distances from gas pipes, liquid propane tanks, and electric transmission lines;
- The prohibition from location inside a building;
- The required 3-foot separation distance from a building; and
- The requirement to extend the casing 12 inches above ground.

All other construction, maintenance, and sealing requirements of Minnesota Rules, parts 4725.2010 through 4725.3875 and this rule part apply.

**Subp. 4. Hydraulic fluid leakage protection.** Hydraulic fluid must be protected from leakage by:

One (or more) of the three methods for leakage protection must be used on new installations and (as specified in subpart 5) when a cylinder is removed and replaced.

**A. attaching a watertight cap or plate to the bottom of the casing and surrounding the casing with neat-cement or cement-sand grout. The grout must extend at least three inches above and inches below the bottom of the casing. The grout must be inserted according to part 4725.3050, subpart 2;**

The cap or plate must be of material equivalent to the casing. The cap must be welded or threaded to the bottom of the casing.

**B. grouting the inside of the casing with cement-sand grout or neat-cement grout. The grout must extend at least two feet above the bottom of the casing and be inserted in accordance with part 4725.3050, subpart 2; or**

**C. encasing the hydraulic cylinder in a Schedule 30 plastic outer pipe or sleeve with the bottom of the pipe or sleeve capped and the top extending above the pit floor.**

The plastic sleeve is not a structural casing, but a “container” to catch leaked hydraulic fluid. The plastic sleeve does not have to be 3.0 inches (or 3.5 inches) smaller than the casing, since it is not a structural part of the boring. Materials heavier than Schedule 30 may be used. The joints of the pipe must be solvent welded or threaded watertight. The sleeve must be large enough to hold all the hydraulic fluid in the hydraulic system or constructed so that hydraulic-fluid leakage overflowing the sleeve will not run into the casing.

**Subp. 5. Repair.** In addition to the requirements of part 4725.3750, when a hydraulic cylinder is removed from an elevator boring for repair or replacement, the boring must be protected from hydraulic fluid leakage according to subpart 4.

**Subp. 6. Sealing.** An elevator boring which is unsuccessful or no longer in use, must be sealed according to part 4725.3850. The hydraulic cylinder, debris or obstructions, and sand placed around the hydraulic cylinder must be removed prior to sealing.

**STAT AUTH: MS s 103I.101; 103I.111; 103I.205; 103I.221; 103I.301; 103I.401; 103I.451; 103I.501; 103I.525; 103I.531; 103I.535; 103I.541; 103I.621; 144.05; 144.12; 144.383; 157.04; 157.08; 157.09; 157.13**

**HIST: 17 SR 2773; 33 SR 211**

**4725.7400 [Repealed, 17 SR 2773]**

## **ENVIRONMENTAL BORE HOLES**

### **4725.7450 ENVIRONMENTAL BORE HOLES.**

#### **ENVIRONMENTAL BORE HOLE DEFINITION**

In order for an excavation or drill hole to be an environmental bore hole, it must meet **ALL** three conditions:

- A. **THE DRILL HOLE MUST INTERCEPT A WATER-BEARING LAYER.** For the purposes of the rules, a water-bearing layer is interpreted to mean an aquifer. An aquifer is a saturated geologic material that can transmit sufficient quantity of water to supply a well. An aquifer will have a hydraulic conductivity of  $10^{-6}$  cm/sec or greater. Typically, an aquifer will have a sustained yield of .25 gallons per minute or greater. For the purposes of the rule, an artificially created basin, not hydraulically connected (less than  $10^{-6}$  cm/sec hydraulic conductivity) to the earth outside the artificial basin, is not considered a water-bearing layer. Such basins may include a landfill liner or an excavated basin in clay for petroleum tanks.
- B. **THE DRILL HOLE MUST BE EITHER DEEPER THAN 25 FEET OR PENETRATE A CONFINING LAYER.** The depth is measured to the deepest penetration of the drill hole. A confining layer in unconsolidated materials, bedrock including the Paleozoic confining layers as specified in Minnesota Rules, part 4725.2020 except for the Decorah and Glenwood formations, must be a minimum of 10 feet thick. The Decorah or Glenwood must be a minimum of 2 feet thick to be considered a confining layer. If a confining layer is penetrated, the drill hole is an environmental bore hole. Peat and muck-swamp deposits are not considered confining layers.
- C. **THE DRILL HOLE MUST BE USED FOR TESTING WITHOUT EXTRACTING WATER OR BE USED FOR VENTING, VAPOR RECOVERY, OR SPARGING TO REMOVE SOIL OR GROUNDWATER CONTAMINATION.** Testing includes measuring a water level, testing earth properties or obtaining geologic samples for identification or other testing.

Examples of environmental bore holes include piezometers, soil borings, geologic test holes, push probe holes, inclinometers, pressure transducers, and vents or air sparging points that meet the requirements of the definition above.

An excavation or drill hole from which a water sample is removed, even if only a single sample is removed, and regardless of depth, is a monitoring well not an environmental bore hole.

#### **REGISTRATION/LICENSING TO CONSTRUCT OR SEAL AN ENVIRONMENTAL BORE HOLE**

A person must be either licensed as a well contractor or registered as a monitoring well contractor to construct, repair, modify, or seal an environmental bore hole as detailed in Minnesota Rules, part 4725.0475.

Environmental bore holes must be constructed, maintained and sealed according to the requirements of Minnesota Rules, parts 4725.2010 to 4725.3875 and this part.



## PERMITS AND REPORTS

Neither a permit nor a notification is required to construct or seal an environmental bore hole. A construction report must be submitted unless the boring is sealed within 30 days. A sealing report must be submitted within 30 days of sealing. Environmental bore holes with similar geology and construction and on a single continuous piece of property may be reported on one sealing report (provided the differences in depth is less than 25 feet) and a drawing is submitted describing the locations of the bore holes.

A flow chart is included after part 4725.0100, subpart 30m that details the definitions and permitting requirements for environmental bore holes and monitoring wells.

***Subpart 1. Construction.*** *An environmental bore hole must be constructed, repaired, maintained, and sealed according to the general standards in parts 4725.2010 to 4725.3875. In addition, an environmental bore hole that is cased must be constructed to conform to the monitoring well requirements in parts 4725.6650 to 4725.6850.*

In addition to the general construction standards that apply to all wells and borings in Minnesota Rules, parts 4725.2010 to 4725.3875, an environmental bore hole must follow the requirements in this rule part, and environmental bore holes which are cased must follow the monitoring well construction requirements in Minnesota Rules, parts 4725.6650 to 4725.6850.

***Subp. 2. At-grade bore holes.*** *An environmental bore hole cased and completed at-grade must conform to part 4725.6850.*

***Subp. 3. Sealing.*** *An environmental bore hole that is not in use or that serves as a potential or actual source of contamination must be sealed according to this chapter.*

The sealing standards of Minnesota Rules, part 4725.3850 apply, except for the exception in subpart 4.

***Subp. 4. Exception to sealing requirements.*** *An environmental bore hole less than 50 feet in depth, in an unconsolidated formation, and not encountering a confining layer may be sealed by removing the casing and screen and allowing the bore hole to collapse, except for a flowing boring which must meet the requirements of part 4725.3850.*

***A.*** *The bore hole must not encounter pollution or contamination or have been installed to detect pollution or contaminants.*

***B.*** *The collapse must not be induced other than by removal of the screen or casing.*

***C.*** *The portion of the bore hole that does not collapse must be sealed immediately upon removal of the casing as specified in part 4725.3850 with bentonite grout, neat-cement grout, or cement-sand grout.*

***Subp 5. Screen or open hole across an unconsolidated formation and bedrock contact. An environmental bore hole may be constructed to test contaminants without extracting water, or to vent, recover vapor, or sparge contaminants from the water surface, by placing a screen or open hole across the contact of an unconsolidated formation and bedrock according to part 4725.6050, subpart 3.***

Environmental bore holes constructed with **multiple casings** completed at different intervals in a single bore hole are prohibited. Environmental bore holes constructed with multiple ports in multiple aquifers or confining layers in a single bore hole are prohibited.

Environmental bore holes that flow may only be sealed with neat-cement grout or sand-cement grout.

An environmental bore hole may be located inside a **building** if the boring is sealed within 72 hours of the time construction begins on the bore hole.

An environmental bore hole may be within 3 feet of a building if it is sealed within 72 hours of the time construction begins on the well or bore hole.

### **INCLINOMETERS**

“**Inclinometers**” are environmental bore holes if the inclinometer meets the conditions explained at the beginning of this rule part (penetrates a water-bearing layer and is deeper than 25 feet or penetrates a confining layer). Inclinometers meeting these conditions must be constructed to the standards of these rules except that ABS inclinometer casing Standard Dimension Ratio 21 or less, with solvent-welded joints may be used. Rivets or screws may not be used to connect casing sections.

***STAT AUTH: MS s 103I.101; 103I.111; 103I.205; 103I.221; 103I.301; 103I.401; 103I.451; 103I.501; 103I.525; 103I.531; 103I.535; 103I.541; 103I.621; 144.05; 144.12; 144.383; 157.04; 157.08; 157.09; 157.13***

***HIST: 17 SR 2773; 33 SR 211***

***4725.7500 [Repealed, 17 SR 2773]***

***4725.7600 [Repealed, 17 SR 2773]***

***4725.7605 [Repealed, 17 SR 2773]***

**End  
of  
Environmental Bore Holes Section**

## APPENDICES INDEX

### APPROVED MATERIALS

- American National Standards Institute (ANSI)/NSF International (NSF) Standard 60 certified drilling aids and sealants
- Foams, weighting agents, and lost circulation materials
- American National Standards Institute (ANSI)/NSF International (NSF) Standard 60 certified well cleaning aids and well rehabilitation aids
- Federal Insecticide, Fungicide, and Rodenticide Act (FIFRA) registered chlorine products
- Pitless adapters and units
- Buried pressure tanks
- Manhole vaults for at-grade casing termination

### RULES AND LAW

- Variance rule, Minnesota Rules, part 4717.7000
- Minnesota Plumbing Code:
  - part 4715.0200 A (potable water required)
  - part 4715.0310 (public water connection)
  - part 4715.0320 (where the Minnesota Plumbing Code applies)
  - part 4715.1910 (marking nonpotable water pipes)
  - part 4715.2010 – 4715.2120 (air gap and backflow)
  - part 4715.2440 (design of sumps)
  - part 4715.2820 (air test of sewer pipes)
- Minnesota Statutes, Chapter 103I – Wells, Borings and Underground Uses

### INFORMATION

### ABBREVIATIONS

### CONTACTS, PHONE NUMBERS, WEB SITES

- MDH district map and phone numbers
- State agency phone numbers and Web sites
- Groundwater related contacts
- Delegated well program contacts and phone numbers
- County planning and zoning officials

### VOLUME OF CASING, HOLE OR ANNULAR SPACE

- Volume of casing or hole
- Annular volume between a casing and an open hole
- Annular volume between two steel casings

### CASING

- Inner and outer casing combinations
- American National Standards Institute (ANSI) pipe schedules

### FLOW CALCULATIONS

- Estimating flow from pipes
- Flow rate conversion table

## **CONVERSION FACTORS**

- Conversion factors, water calculations
- Conversion factor tables
- Calculating volumes and areas

## **PROPERTY LOCATION**

### **GROUNDWATER, GEOLOGY**

- Minnesota groundwater
- State hydrogeologic map
- Geologic column of southeast Minnesota

### **WELL SEALING**

- Well disclosure
- Finding lost wells

## **GEOHERMAL**

## **SPECIAL WELL AND BORING CONSTRUCTION AREAS**

### **WATER QUALITY**

- Arsenic
- Coliform bacteria
- Nitrate
- Additional water tests
- Groundwater Values
- Health Risk Limits (HRLs), Health Based Values (HBV), Risk Assessment Advice (RAA)

**American National Standards Institute (ANSI)/NSF International (NSF)  
 STD 60 Certified Well Drilling Aids and Well Sealants  
 January 19, 2010<sup>a,b</sup>**

(Current list available on the MDH Well Management Section Web site at:  
[www.health.state.mn.us/divs/eh/wells/lwcinfo](http://www.health.state.mn.us/divs/eh/wells/lwcinfo))

<b><u>COMPANY</u></b>	<b><u>PRODUCT</u></b>	<b><u>LISTED FUNCTION</u></b> <sup>1,2</sup>
<b>ABI, INC.</b> 375 Roma Jean Parkway Streamwood, IL 60107 800-992-2880 630-372-7300	ABI Crumbles	well drilling aid
	ABI Gel	well drilling aid
	ABI Granular	well drilling aid
	ABI Grout	well drilling aid
	ABI Hi Yield (ABI High Yield)	well drilling aid
	ABI Plug	well drilling aid
<b>ADVANCE CHEMICAL SOLUTIONS, INC.</b> P.O. Box 702188 Tulsa, OK 74170-2188 918-625-2421	WT-3272-P <sup>3,4</sup>	well drilling aid
	WT-3805-P <sup>3,4</sup>	well drilling aid
	WT-3806-P <sup>3,4</sup>	well drilling aid
	WT-3882-P <sup>3,4</sup>	well drilling aid
	<del>WT-3807</del>	
<b>AKZONOBEL SURFACE CHEMISTRY LLC</b> <b>[ALCO CHEMICAL]</b> 909 Mueller Drive Chattanooga, TN 37406-0401 800-251-1080 or 423-629-1405	Alcodrill HPD-L <sup>3,4</sup>	well drilling aid
<b>ARIES CHEMICAL, INC.</b> 6604 Depot Street P.O. Box 519 Beaver Falls, NY 13305 315-346-1489	Aries 3640 <sup>3,4</sup>	well drilling aid
<b>ASHLAND, INC.</b> 2401 Doyle Street Greensboro, NC 27406 336-333-3570	Praestol A3040 LTR <sup>3,4</sup>	drilling fluid
<b>ASTECC UNDERGROUND</b> 9600 Corporate Park Drive Loudon, TN 37774 865-408-2100	Astec High Yield	well drilling aid
<b>BAKER HUGHES INTEQ DRILLING FLUIDS</b> P.O. Box 670968 Houston, TX 77267-0968 713-625-4200	Newdrill <sup>3,4</sup>	well drilling aid
	Super-Ben	well drilling aid
	Super-Bore	drilling fluid
	Super-Col	drilling fluid, well drilling aid
	Super-Seal	well sealant

<u>COMPANY</u>	<u>PRODUCT</u>	<u>LISTED FUNCTION</u> <sup>1,2</sup>
<b>BAROID INDUSTRIAL DRILLING PRODUCTS [HALLIBURTON]</b> 3000 North Sam Houston Parkway East Houston, TX 77032 281-871-5900	AQF-2 <sup>5</sup>	foaming agent
	Aquagel	drilling fluid
	Aquagel Gold Seal	drilling fluid
	Aqua-Grout	well sealant
	Aquaguard	well sealant
	<b>Baroid Bentonite Pellets</b>	well sealant
	Barotherm <sup>6</sup>	well sealant
	Barotherm Plus <sup>6</sup>	well sealant
	<b>Barotherm Gold<sup>6</sup></b>	well sealant
	Benseal	well sealant
	Bore-Gel	drilling fluid
	<b>Bore-Grout</b>	well sealant
	Casing Seal	well sealant
	EZ-Mud <sup>3,4</sup>	well drilling aid
	EZ-Mud DP <sup>3,4</sup>	well drilling aid
	EZ-Mud Gold <sup>3,4</sup>	well drilling aid
	EZ-Mud Plus <sup>3,4</sup>	well drilling aid
	EZ Seal	well sealant
	Holeplug	well sealant
	Holeplug 3/4 and 3/8	well sealant
	IDP-334	well sealant
	<b>IDP-502<sup>6</sup></b>	well sealant
	N-Seal	drilling fluid
	Poly-Bore <sup>3,4</sup>	well drilling aid
	Quik-Foam <sup>5</sup>	foaming agent
	Quik-Gel	drilling fluid
	Quik-Gel Gold	well drilling aid, drilling fluid
	Quik-Grout	well sealant
	Quik Mud D-50 <sup>3,4</sup>	well drilling aid
	Quik Mud Gold <sup>3,4</sup>	well drilling aid
Quik-Trol <sup>3</sup>	well drilling aid	
Quik-Trol Gold <sup>3</sup>	well drilling aid	
<b>Quik-Trol Gold LV<sup>3</sup></b>	well drilling aid	
Quik-Trol LV <sup>3</sup>	well drilling aid	
<del>Aqua-Grout Catalyst, Penetrol, Shur-Gel</del>		
<b>BLACK HILLS BENTONITE, LLC</b> 55 Salt Creek Highway Casper, WY 82601 800-788-9443 307-265-3740	Bentonite Grout	well sealant
	Bentonite Plug	well sealant
	BH Grout 20	well sealant
	BH Grout Ultra	well sealant
	Thermal Grout Lite <sup>6</sup>	well sealant
	Thermal Grout Select <sup>6</sup>	well sealant
<del>Thermal Grout 85</del>		
<b>BUCKLEY POWDER COMPANY</b> 42 Inverness Drive East Engelwood, CO 80112 307-265-3740	<b>Buckley Bentonite Plug 3/8"</b>	well sealant
	<b>Buckley Bentonite Plug 3/4"</b>	well sealant
<b>C.C.I.</b> 3540 East 26th Street Vernon, CA 90023 800-767-9112 or 323-265-3111	CP-9900 <sup>3,4</sup>	well drilling aid

<u>COMPANY</u>	<u>PRODUCT</u>	<u>LISTED FUNCTION</u> <sup>1,2</sup>
<b>COLLOID ENVIRONMENTAL TECHNOLOGIES COMPANY [CETCO]</b> 2870 Forbs Avenue Hoffman Estates, IL 60192 800-527-9948 847-851-1824	ACCU-VIS <sup>3,4</sup>	well drilling aid
	Belle Crumbles	well sealant
	BentoGrout	well sealant
	CETCO Coated Tablets 1/4 and 3/8"	well sealant
	CETCO/Volclay Chips	well sealant
	CETCO/Volclay Crumbles	well sealant
	CETCO/Volclay Granular Grout	well sealant
	CETCO/Volclay Grout	well sealant
	CETCO/Volclay/PureGold Chips	well sealant
	CETCO/Volclay/PureGold Tablets	well sealant
	CETCO/Volclay Tablets	well sealant
	C/S Granular	well sealant
	Geothermal Grout <sup>6</sup>	well sealant
	High TC Geothermal Grout <sup>6</sup>	well sealant
	Hydraul EZ	drilling fluid, well drilling aid
	Insta-Pac <sup>3,4</sup>	well drilling aid
	Insta-Vis Plus <sup>3,4</sup>	well drilling aid
	PureGold Gel	well sealant
	PureGold Grout	well sealant
	Shore Pac Liquid <sup>3,4</sup>	well drilling aid
	Super Gel-X	drilling fluid, well drilling aid
	Super Thin <sup>3</sup>	well drilling aid, well cleaning aid
	Versafoam Plus <sup>5</sup>	foaming agent
Xtra Gel	well drilling aid	
Insta Pac GP, PolyPill Type PS1, Premium Gel, SG 40, Volclay Grout II		
<b>CHAMELEON INDUSTRIES, INC.</b> P.O. Box 853027 Mesquite, TX 75185-3027 903-874-9005	CI1066BPWG <sup>4</sup>	well drilling aid
	CI1066PWG <sup>4</sup>	well drilling aid
	EM 533 B-30, EM 533 PWG	
<b>CIBA CORPORATION</b> 2371 Wilroy Road Suffolk, VA 23439 800-322-3885 757-538-5240	Agefloc WT6303 <sup>3,4</sup>	well drilling aid
	Agefloc WT6323 <sup>3,4</sup>	drilling fluid
	Alcomer 74L	well drilling aid
	Alcomer110RD <sup>3,4</sup>	well drilling aid
	Alcomer 120L <sup>3,4</sup>	well drilling aid
	Alcomer 123LA <sup>3,4</sup>	well drilling aid
	Alcomer XX-Poly <sup>3,4</sup>	well drilling aid
	Magnafloc 120L <sup>3,4</sup>	well drilling aid
	Magnafloc E40 <sup>3,4</sup>	well drilling aid
Magnafloc E40S <sup>3,4</sup>	drilling fluid	
<b>ECONOMY MUD PRODUCTS COMPANY</b> 435 East Anderson Road P.O. Box 450246 Houston, TX 77245 713-723-8416	Economy Gel	well drilling aid
	Econoplug Coarse	well drilling aid
	Econoplug Grout	well sealant
	Econoplug Medium	well drilling aid
	Econoplug No. 8 & No. 16	well drilling aids
	Poly Gel	well drilling aid
Bentonite Pellets		
<b>G.S. ROBINS AND COMPANY</b> 126 Chouteau Avenue St. Louis, MO 63102 314-621-5155	RobinFloc 4382 <sup>3,4</sup>	well drilling aid



<u>COMPANY</u>	<u>PRODUCT</u>	<u>LISTED FUNCTION</u> <sup>1,2</sup>
<b>HERCULES, INC. - AQUALON</b> [ASHLAND AQUALON] 1313 North Market Street Wilmington, DE 19894 302-594-5000	Aqualon AQU C-4146	well drilling aid
	<b>Aqualon AQU C-4524</b>	well drilling aid
	Aqualon AQU D-4146	well drilling aid
	Aqualon AquaPAC	
<b>HYCHEM, INC.</b> 10014 North Dale Mabry, Suite 213 Tampa, FL 33618 813-963-6214	Hyperdrill AE 853 <sup>3,4</sup>	well drilling aid
	Hyperdrill AE 856 <sup>3,4</sup>	well drilling aid
	Hyperdrill AD 859 <sup>3,4</sup>	well drilling aid
	Hyperdrill DF 2010 <sup>3</sup>	well drilling aid, well cleaning aid
<b>KEMIRA WATER SOLUTIONS, INC. [CYTEC]</b> 808 East Main Street Lakeland, FL 33801 800-533-5990	Cyanatrol 930 <sup>3,4</sup>	well drilling aid
	Cydril 5300 <sup>3,4</sup>	well drilling aid
	Cydril 5310 <sup>3,4</sup>	well drilling aid
	Superfloc A-1820 Flocculant <sup>3,4</sup>	well drilling aid
	Superfloc A-1883LMW <sup>3,4</sup>	well drilling aid
<b>LYNCOLE XIT GROUNDING</b> 3547 Voyager Street, No. 104 Torrance, CA 90503 800-962-2610 or 310-214-4000	Lynconite	well sealant
	Lynconite II	well sealant
	Lyncole Grounding Gravel	well sealant
<b>MINING DRILLING FLUIDS [MDF]</b>  Nueva York 25 Santiago Centro, Chile	MDF Disper Thin <sup>3</sup>	well drilling aid, well cleaning aid
<b>M-I, LLC</b> [M-I SWACO] A Smith/Schlumberger Company 5950 North Course Drive Houston, TX 77072 832-295-2747	Aztec Hi-Yield	well drilling aid
	<b>Drilplex HDD<sup>3</sup></b>	well drilling aid
	Federal Bentonite	well drilling aid, well cleaning aid
	Gopher Grout	well sealant
	Kwik-Plug	
	Coarse, Fine, Medium, & Micro	well sealants
	Kwik-Plug Pellets Coated (1/2, 1/4, and 3/8 inch)	well sealants
	Kwik-Plug Pellets Uncoated (1/2, 1/4, and 3/8 inch)	well sealants
	M-I Gel	well drilling aid, well cleaning aid
	M-I Gel Supreme	well drilling aid
	Max Gel	well drilling aid
	Platinum Foam Plus <sup>5</sup>	foaming agent
	Platinum PAC	well drilling aid
	Platinum PAC UL	well drilling aid
	Poly-Plus <sup>3,4</sup>	well drilling aid
Poly-Plus 2000 <sup>3,4</sup>	well drilling aid	
<b>Poly-Plus EHV<sup>3,4</sup></b>	well drilling aid	
<b>Poly-Plus LV<sup>3,4</sup></b>	well drilling aid	
<b>Poly-Plus RD<sup>3,4</sup></b>	well drilling aid	

<b><u>COMPANY</u></b>	<b><u>PRODUCT</u></b>	<b><u>LISTED FUNCTION</u></b> <sup>1,2</sup>
	Ringfree <sup>3</sup>	well drilling aid, well cleaning aid
	Smooth Grout 20	well sealant
	Smooth Grout 30	well sealant
	Smooth Grout Thermal <sup>6</sup>	well sealant
	Tackle <sup>3</sup>	well drilling aid
	<del>Case High Yield, Federal High Yield, Federal Jel 90, Federal Supreme, Kwik Thik, , Pargel 220, Smoothbore</del>	
<b>MILLENNIUM WATER MANAGEMENT, LTD</b> 65 Coventry Lane Dartmouth, NS B2V 2K5 Canada 902-462-3868	MWML EM 533PWG <sup>4</sup>	well drilling aid
<b>MINEX, LLC</b> 115 South 14½ Avenue West Virginia, MN 55792 800-582-7171 218-741-7300	1330 <sup>3,4</sup> Minex 1330 <sup>3,4</sup>	well drilling aid well drilling aid
<b>NALCO COMPANY</b> 1601 West Diehl Rd. Naperville, IL 60563 630-305-1000	Nalco ASP-700 <sup>3,4</sup> <del>T-100, T-150 MUD, Clearmud</del>	drilling fluid
<b>NDS DRILLING</b> 26041 Newton Circle Elko, MN 55020-9534 952-461-3400	T-100 MUD <sup>3,4</sup>	drilling fluid
<b>PAR CHEM</b>	<del>Pargel 220, Bore Flow</del>	
<b>POLYMER DRILLING SYSTEMS, INC.</b> <b>[PDSCO]</b> 105 West Sharp El Dorado, AR 71730 800-234-7455 870-863-5707	Bentonite Plug Bentonite Plug TR30, TR 60, and TR90 Bentonite Powder Coarse Plug Cowboy Brand Bentonite Pellets Cowboy Brand Granular Seal Cowboy Brand Grout Cowboy Brand Plug Coarse Cowboy Brand Plug Fine Cowboy Brand Plug Medium Fine Plug Granular Seal Granular Seal TR30 Grout Medium Plug Natural Bentonite Gel PDS Co Bentonite Pel Plug Pel-Plug TR30, TR60, and TR90 <del>PDSCo Gel, PDSCO Granular Seal, PDSCO Grout, PDSCO Hi Yield, PDSCo High Yield Gel, PDSCo Natural Bentonite Gel, PDSCO Plug</del>	well sealant well sealant

<p><b>POLLU-TECH, INC.</b> 853 Second Street Pike Brownstone II, Suite B-200 Richboro, PA 18954 215-357-1821</p>	<p>Pollu-Treat AE-601-PWG<sup>3,4</sup></p>	<p>drilling fluid</p>
<p><b>POLY-DRILL DRILLING SYSTEMS LTD.</b> 2192-8800 Venture Avenue SE Calgary, Alberta T3S 0A2 Canada 403-259-5112</p>	<p><b>Betta-Gel Coated Bentonite Pellets</b></p>	<p>well drilling aid well sealant</p>
<p><b>QUALITY DRILLING FLUIDS, LLC</b> 13027 County Road 18 Fort Lupton, CO 80621 303-857-4171</p>	<p>Hydrothin<sup>3,4</sup> Hydrovis-30<sup>3,4</sup> Hydrovis-50<sup>3,4</sup> Hydrovis-Dry<sup>3,4</sup></p>	<p>well drilling aid well drilling aid well drilling aid well drilling aid</p>
<p><b>SEATEX, LTD</b> 445 Texas 36 P.O. Box D Rosenberg, TX 77471 800-829-3020 713-357-5300</p>	<p>Drill Foam Premium<sup>5</sup></p>	<p>foaming agent</p>
<p><b>SNF, INC.</b> P.O. Box 250 Riceboro, GA 31323 912-884-3366 [CHEMTALL, INC. is a subsidiary of SNF INC.]</p>	<p>Clarifloc A-3333P<sup>3,4</sup> <b>FLOPAM AN 923 SHU PWG<sup>3,4</sup></b> <b>FLOPAM AN 923 SHU QW4 PWG<sup>3</sup></b> <b>FLOPAM AN 923 VLM PWG<sup>3,4</sup></b> <b>FLOPAM AN 923 VLM QW4 PWG<sup>3</sup></b> FLOPAM AN 934 BPM PWG<sup>3,4</sup> FLOPAM AN 934 PWG<sup>3,4</sup> <b>FLOPAM AN 945 PWG<sup>3,4</sup></b> FLOPAM DW 533 PWG<sup>3,4</sup> FLOPAM EM 533 B30 PWG<sup>3,4</sup> FLOPAM EM 533 PWG<sup>3,4</sup> FLOPAM EMF 533 PWG<sup>3,4</sup> Flosperse 3000 PWG<sup>3</sup>  <b>Flosperse 3018 CS PWG<sup>3</sup></b> <del>Floerger EM 533 PWG,</del> <del>Floerger EM 533B30 PWG</del></p>	<p>well drilling aid well drilling aid well drilling aid well drilling aid well drilling aid well drilling aid well drilling aid well drilling aid well drilling aid well drilling aid well drilling aid well drilling aid, well cleaning aid well drilling aid</p>
<p><b>SOUTHERN WATER CONSULTANTS, INC.</b></p>	<p>APE-4254SP</p>	
<p><b>TEAGUE MINERAL PRODUCTS</b> 1925 Highway 201 South Adrian, OR 97901 541-339-3940</p>	<p>Custom Sealant Industrial 200 Perma Plug</p>	<p>well sealant well sealant well sealant</p>

<u>COMPANY</u>	<u>PRODUCT</u>	<u>LISTED FUNCTION</u> <sup>1,2</sup>
<b>UNITECH CHEMICALS [ZIBO] LIMITED</b> 6114 LaSalle Avenue, No. 118 Oakland, CA 94611 510-428-2880	Dynapac DHV Dynapac DHV Plus Dynapac DLV Dynapac DLV Plus	well drilling aid well drilling aid well drilling aid well drilling aid
<b>U.S. BENTONITE</b> P.O. Box 1067 Granger, IN 46530 888-737-4116	Pro Gel Pro-Plug <del>Pro-Seal</del>	well drilling aid well sealant
<b>VEOLIA WATER SOLUTIONS &amp; TECHNOLOGIES</b> 945 South Brown School Road Vandalia, OH 45377 937-890-4075	<b>Hydrex 3757</b> <sup>3,4</sup>	well drilling aid
<b>WESTERN CLAY COMPANY</b> 620 East SR 24 Aurora, UT 84620 800-982-7960 435-529-3281	Prime-Gel <b>Prime-Gel Premium</b> <b>SLIKGEL High Yield</b> Swell Plug Coarse <del>Prime-Gel Gold, Western Extra High Yield</del>	drilling fluid, well drilling aid drilling fluid, well drilling aid drilling fluid, well drilling aid well sealant
<b>WESTERN HYDRO CORP.</b> 3449 Enterprise Avenue Hayward, CA 94545 510-783-9166	Drill Mud 220 Hydro Bore 240 <b>Hydro Foam</b> <sup>5</sup> Hydro Grout 20 Hydro Grout 30 Hydro Plug 3/8 and 3/4 Hydro Plug 8 and 16 Hydro Polymer <sup>3,4</sup> Hydro Thin	well drilling aid well drilling aid foaming agent well sealant well sealant well sealants well sealants well drilling aid well drilling aid
<b>WYO-BEN, INC.</b> 1345 Discovery Drive Billings, MT 59102 406-652-6351 800-548-7055	<b>Air Foam</b> <sup>5</sup> <b>Dril-Trol LV</b> <b>Dril-Trol QD</b> e-Grout Enviroplug Coarse Enviroplug Grout Enviroplug Medium Enviroplug No. 8, No. 16, and No. 20 Extra High Yield Bentonite Grout-Well Grout-Well DF Hydrogel Micro-Gel MTA-1 Naturalgel Plugz-It Plugz-It Max SW101 TD-16 Therm-Ex Grout <sup>6</sup>	foaming agent well drilling aid well drilling aid well sealant well sealant well sealant well sealants well drilling aid well sealant well sealant well sealant well drilling aid well drilling aid well drilling aid well drilling aid well sealant well sealant well drilling aid well sealant well sealant

**COMPANY****PRODUCT****LISTED FUNCTION<sup>1,2</sup>**

Therm-Ex Grout Plus<sup>6</sup>  
 Thinz-It  
 Tru-Bore  
 VC-55<sup>3,4</sup>  
 Wyo-Foamer<sup>5</sup>  
 Wyo-Vis<sup>3,4</sup>

well sealant  
 well drilling aid  
 well drilling aid  
 well drilling aid  
 foaming agent  
 well drilling aid, drilling fluid

**Notes:**

<sup>a</sup> This list was compiled using listings found on the NSF internet site, *www.nsf.org*. Other organizations accredited by ANSI to perform testing and certification to the NSF/ANSI standards for drinking water treatment additives did not have any listings for drilling aids or sealants at the time this list was compiled. Products that are crossed out (~~strikeout~~) have been listed previously, but are not on the current list. These products should not be considered approved for use unless the product package is marked with the NSF certification. Products that are highlighted are listings that have been added since the January 12, 2009, update of this Minnesota Department of Health (MDH) list. Periodic updates to this list will be made available on the MDH Well Management Section Web site at: [www.health.state.mn.us/divs/eh/wells/lwcinfo/drilluids.html](http://www.health.state.mn.us/divs/eh/wells/lwcinfo/drilluids.html).

<sup>b</sup> A cementitious well sealant and a few graphite-based well sealants that are listed by NSF do not appear on this list and have not yet been approved by MDH for use as well sealants in regulated wells and borings in Minnesota.

<sup>1</sup> Products listed as **well drilling aids**, **drilling fluids**, and **foaming agents** are designed to be flushed out prior to using the system for drinking water. The well is to be properly flushed and drained before being placed in service.

<sup>2</sup> For products listed as **well sealants**, the well is to be properly flushed and drained before being placed in service.

- <sup>3</sup>
- a. These products should not be used in constructing wells in highly porous formations such as cavernous limestone.
  - b. Certification of these products is based on a well drilling model with the following assumptions:
    1. The amount of well drilling fluid used is 3780 liters (1,000 gallons), to which the drilling fluid has been added at the level specified in ANSI/NSF Standard 60, or at the manufacturer's recommended level.
    2. The aquifer contains 3.1 million liters of water (815,000 gallons), based on a 0.5 acre aquifer of 6.1 meters depth (20 feet) and 25 percent porosity.
    3. The bore hole is 61 meters in total depth (200 feet), the screen is 6.1 meters in length (20 feet), and the bore hole diameter is 25.4 cm. (10 inches).
    4. The amount of well drilling fluid removed from the well during construction is equal to the combined volumes of the casing, the screen and bore hole annulus around the casing and the screen, plus an additional amount removed through well disinfection and development (90 percent of that initially applied is removed).

<sup>4</sup> These products contain polyacrylamides. Because questions remain regarding potential health risks from exposure to these products, the MDH recommends that they not be used in potable water applications.

<sup>5</sup> Certification of this product is based on a well drilling model using assumptions stated in ANSI/NSF Standard 60, Section 8 for well drilling foamers. These products are designed to be flushed out prior to using the system for drinking water. Before being placed in service, the well is to be properly flushed according to the manufacturer's use instructions.

<sup>6</sup> These products are intended to be mixed with sand at ratios specified by the manufacturer. Some bentonite and sand mixtures do not meet the grouting materials specifications found in Minnesota Rules, part 4725.0100, subpart 21d or part 4725.7050, subpart 1, item D. These mixtures may not be used unless a variance is obtained from the MDH. The MDH has granted variances to allow use of these products.

The August 4, 2008, amendments to Minnesota Rules, Chapter 4725 allow the use of thermally enhanced bentonite grout for grouting the bore hole of a vertical heat exchanger, provided that the thermally enhanced bentonite grout consists of a fluid mixture of not more than 17.5 gallons of water, not more than 200 pounds of sand with 80 percent or more of the sand smaller than 0.0117 inch (passing U.S. Sieve No. 50), and a minimum of 50 pounds of bentonite.

Following is a partial list of requirements for drilling fluids and grouts used in wells and borings in Minnesota (complete requirements can be found in Minnesota Rules, Chapter 4725, Wells and Borings):

- Drilling fluid additives, including bentonite, must meet the requirements of ANSI/NSF Standard 60-2003e.
- Bentonite used for grout must meet ANSI/NSF Standard 60, or be a natural bentonite without additives.
- Grout must be mixed into a water slurry and pumped through a tremie pipe or the casing.
- Bentonite pellets, chips, and dry granular bentonite may be used only as an intermediate seal between a gravel pack and grout in any regulated well or boring. The layer of bentonite pellets, bentonite chips, or granular bentonite must not exceed 5 feet in thickness, must not extend into a confining layer, and must not extend more than 10 feet above the static water level.

**MDH APPROVED DRILLING FOAMS, WEIGHTING  
MATERIALS, AND LOST CIRCULATION MATERIALS**

**April 28, 2008**

<b><u>COMPANY</u></b>	<b><u>PRODUCT</u></b>	<b><u>FUNCTION</u></b>
<b>AQUA-CLEAR</b>	Airfoam AP-50	foaming agent
<b>HALLIBURTON/ BAROID PSL</b>	AQF-2* Baroid	foaming agent weighting material
Drilfoam	foaming agent	
Micatex	lost circulation material	
N-Seal*	lost circulation material	
Quik-Foam*	foaming agent	
<b>CETCO</b>	Versa Foam	foaming agent
<b>DESERT DRILLING FLUIDS</b>	Amfoam	foaming agent
<b>WYO-BEN</b>	Air Foam	foaming agent
Plugz-It*	lost circulation material	
Plugz-It/Max*	lost circulation material	
Wyo-Foamer	foaming agent	

\*NSF/ANSI Standard 60 Certified

Following is a partial list of requirements for drilling fluids and grouts used in wells and borings in Minnesota (complete requirements can be found in Minnesota Rules, Chapter 4725, Wells and Borings):

- Drilling fluid additives, including bentonite, must meet the requirements of American National Standards Institute (ANSI)/ NSF International (NSF) Standard 60-2003e. The MDH has developed a supplementary list (above) of foams and lost-circulation materials.
- Bentonite used for grout must meet ANSI/NSF Standard 60, or be a natural bentonite without additives.
- Grout must be mixed into a water slurry and pumped through a tremie pipe or the casing.
- Bentonite pellets, chips, and dry granular bentonite may be used only as an intermediate seal between a gravel pack and grout in any regulated well or boring. The layer of bentonite pellets, bentonite chips, or granular bentonite must not exceed 5 feet in thickness, must not extend into a confining layer, and must not extend more than 10 feet above the static water level.

**American National Standards Institute (ANSI)/NSF International (NSF)  
Standard 60 Certified Well Cleaning Aids and Well Rehabilitation Aids<sup>1,2</sup>  
January 12, 2009<sup>a</sup>**

(Current list available on the MDH Well Management Section Web site at:  
[www.health.state.mn.us/divs/eh/wells/lwcinfo](http://www.health.state.mn.us/divs/eh/wells/lwcinfo))

**COMPANY**

**PRODUCT**

**BRAINERD CHEMICAL COMPANY, INC.**

1200 North Peoria  
Tulsa, OK 70106  
800-551-5128  
918-622-1214

**Citric Acid 50% Solution**

**Citric Acid Solution**

**CANADA COLORS  
AND CHEMICALS LIMITED**

80 Scarsdale Road  
Don Mills, ON M3B 2R7  
Canada  
416-449-7750

Citric Acid 50% Solution (PWTG)

**CARUS CORPORATION/CALCIQUEST INC.**

315 Fifth Street  
P.O. Box 599  
Peru, IL 61354-0599  
800-435-6856  
815-223-1500

CARUS Intellichlor  
~~F-25 Filter Conditioner, F-25 Well Conditioner,~~  
~~IntelliClor-A, IntelliClor-Chlorine Enhancer,~~  
~~OPTICL20R, ZPX-1 Well Conditioner~~

**COLLOID ENVIRONMENTAL  
TECHNOLOGIES COMPANY (CETCO)**

2870 Forbs Avenue  
Hoffman Estates, IL 60192  
800-527-9948  
847-851-1800

BMR (Bentonite Mud Remover)  
DPA (Dry Penetrating Acid)  
Super Thin

**COTEY CHEMICAL CORPORATION**

4410 Martin Luther King Boulevard  
P.O. Box 2039  
Lubbock, TX 79408  
806-747-2096

BioClean  
Dry Acid Special  
Liquid Acid Descaler  
Wel-Chlor

**DESIGN WATER TECHNOLOGIES**

5920 Covington Road  
Shorewood, MN 55331  
952-474-4657

UNICID Catalyst

**COMPANY****DUPONT CHEMICAL SOLUTIONS  
ENTERPRISE**

901 West DuPont Avenue  
Belle, WV 25015  
304-357-1456

**FLORAN TECHNOLOGIES, INC.**

801 Southwest 89th Street, Building B  
Oklahoma City, OK 73139  
866-463-5672  
405-631-1106

**G. E. BETZ, D.B.A.****GE WATER AND PROCESS TECHNOLOGIES**

4636 Somerton Road  
Trevose, PA 19053  
215-942-3435

**HALLIBURTON/BAROID PSL**

3000 North Sam Houston Parkway East  
Houston, TX 77032  
281-871-5900

**H.E.R.C. PRODUCTS INCORPORATED**

~~Well Klean II Concentrate Extra, Well Klean Preblend~~

**HYCHEM, INC.**

10014 North Dale Mabry, Suite 213  
Tampa, FL 33618  
813-963-6214

**JOHNSON SCREENS**

1950 Old Highway 8  
P.O. Box 64118  
New Brighton, MN 55112  
800-833-9473  
651-636-3900

**LAYNE CHRISTENSEN COMPANY**

1900 Shawnee Mission Parkway  
Mission Woods, KS 66205  
913-362-0510

**M-I, LLC**

A Smith/Schlumberger Company  
5950 North Course Drive  
Houston, TX 77072  
832-295-2747

**PRODUCT**

Glycolic Acid 70% Technical Solution  
Hydroxyacetic Acid  
Hydroxyethanoic Acid

Floran Biogrowth Remover  
Floran F-25  
Floran Neutralizer

Betz MPH5000  
Citric Acid 50% Solution (PWTG)

Aqua-Clear AE  
Aqua-Clear MGA  
Aqua-Clear PFD  
~~Aqua-Clear MSR~~

~~Acid Klean, Well Klean C, Well Klean II Concentrate,~~

Hyperdrill DF 2010

Chlorine Booster  
NW-100  
NW-110  
NW-220  
NW-310  
NW-400  
NW-410  
Well Acid  
Well Cleaner  
~~Nu-Well~~

QC-21 Well Cleaner  
Layne Oximate

M-I Gel  
Federal Bentonite  
Ringfree  
~~Federal Jel 90~~



**COMPANY****PRODUCT****MINING DRILLING FLUIDS (MDF)**

Nueva York 25  
Santiago Centro, Chile

MDF Disper Thin

**PANTON MC LEOD LIMITED**

One Waverly Place  
Newton St. Boswells  
Melrose  
Roxburghshire  
Scotland, UK TD6 0RS

PM 33  
PM 33sp  
PM 55  
PM 55sp  
PM 88

**SNF INC.**

P.O. Box 250  
Riceboro, GA 31323  
912-884-3366

Floperse 3000 PWG3

**SULCO CHEMICALS LIMITED**

60 First Street East  
Elmira, ON N3B 2Z5  
Canada  
519-669-1332

Betz MPH 5000  
Citric Acid 50% Solution (PWTG)

**WATER SYSTEMS ENGINEERING, INC.**

3201 Labette Terrace  
P.O. Box 700  
Ottawa, KS 66067  
785-242-6166

H-34  
H-39  
H-234  
HES-16A  
MC-101  
S-08  
WA-1

**Notes:**

<sup>a</sup> This list was compiled using listings found on the NSF internet site, *www.nsf.org*. Products that are crossed out [~~strikeout~~] have been listed previously, but are not on the current list. These products should not be considered approved for use unless the product package is marked with the NSF certification. Products that are highlighted are listings that have been added since the January 22, 2008, update of this Minnesota Department of Health (MDH) list. Periodic updates to this list will be made available on the MDH Well Management Section Web site at: *www.health.state.mn.us/divs/eh/wells/lwcinfo/cleanaids.html*.

<sup>1</sup> These products are designed to be flushed out prior to using the system for drinking water. The well is to be properly flushed and drained, following the manufacturer's instructions, before being placed in service. These products must be used in accordance with the manufacturer's use instructions, and in accordance with conditions specified in ANSI/NSF Standard 60.

<sup>2</sup> Minnesota Rules, Chapter 4725, as amended on August 4, 2008, requires that any chemical placed in a well or boring to increase the yield, remove or treat contaminants or objectionable tastes or odors, or rehabilitate the well or boring must meet the requirements of ANSI/NSF Standard 60-2003e. In addition, sodium or calcium hypochlorite would be allowed if registered by the United States Environmental Protection Agency in accordance with the Federal Insecticide, Fungicide, and Rodenticide Act (FIFRA), section 3(c)(7)(A) as an antimicrobial pesticide for use in potable water.

### Products approved by the MDH Well Management Section for Well Disinfection<sup>1</sup>

The following products are registered by the United States Environmental Protection Agency in accordance with the Federal Insecticide, Fungicide, and Rodenticide Act (FIFRA) sec. 3(c)(7)(A) as an antimicrobial pesticide for use in potable water.  
This list is current as of January 28, 2009.

Manufacturer	Registrant, if different from Manufacturer	Label Description	EPA Registration Number	Trade Name(s) as Appear(s) on Minnesota Department of Agriculture Registration List	Active Ingredient
A & L Laboratories Inc.		Al-Clor 10	3276-20002	Al-Clor 10 Disinfectant	sodium hypochlorite 10%
AllChem Performance Products	AP Tech Group Inc.	Chlor Mor Calcium Hypochlorite Tablets	69681-14-55400	Durokleen 101	calcium hypochlorite 68%
Anderson Chemical Co.		Reg 13	150-64	Reg 13	sodium hypochlorite 12.5%
Arch Chemicals Inc.		HTH 300 Gram Tablets	1258-1233	CCH 3" Calcium Hypochlorite Tablets  CCH Chlorinating Tablets  HTH Poolife Autofeed A300 Tablets for Automatic Chlorinators and Feeders  Swimsations by Poolife Aquaboost	calcium hypochlorite 68%
Arch Chemicals Inc.		HTH Dry Chlorinator 20 Gram Tablets	1258-1217	CCH Tablets	calcium hypochlorite 68%
Arch Chemicals Inc.	Nalco Co.	HTH Dry Chlorinator 20 Gram Tablets	1258-1217-1706	Nalco 2590 Tablets Microorganism Control Chemical	calcium hypochlorite 68%

Manufacturer	Registrant, if different from Manufacturer	Label Description	EPA Registration Number	Trade Name(s) as Appear(s) on Minnesota Department of Agriculture Registration List	Active Ingredient
Arch Chemicals Inc.		HTH Dry Chlorinator Granular	1258-427	CCH Granular for Industrial Applications & Swimming Pools  Dry Tec Granular  Drytec Calcium Hypochlorite Granular  Pulsar Granular Calcium Hypochlorite for Commercial Swimming Pool Use	calcium hypochlorite 68%
Arch Chemicals Inc.		HTH Dry Chlorinator Granular for Swimming Pools	1258-1069	HTH Granular Chlorinator Chlorinator  HTH Poolife Active Cleaning Granules Chlorinator  Pool Breeze Pool Care System Granular 68	calcium hypochlorite 68%
Arch Chemicals Inc.	Alliance Trading Inc.	HTH Dry Chlorinator Granular for Swimming Pools	1258-1069-42177	Refresh  Shockwave Shock Treatment for Swimming Pools	calcium hypochlorite 68%
Arch Chemicals Inc.		HTH Dry Chlorinator Tablets for Swimming Pools	1258-969	CCH Tablets  Drytec FG Cal Hypo Briquettes for Municipal & Industrial Water Treatment Application  HTH Chlorinating Briquettes Chlorinator  HTH Poolife Active Cleaning Tablets Chlorinator	calcium hypochlorite 68%

Manufacturer	Registrant, if different from Manufacturer	Label Description	EPA Registration Number	Trade Name(s) as Appear(s) on Minnesota Department of Agriculture Registration List	Active Ingredient
Arch Chemicals Inc.		HTH Duration Tablets	1258-808	HTH Duration Capsules HTH Duration Chlorinator Capsules Chlorinator HTH Duration Cleaning Capsules Chlorinator HTH Poolife Active Cleaning Caplets Chlorinator	calcium hypochlorite 68%
Arch Chemicals Inc.	Hydro Magic LLC	HTH Duration Tablets	1258-808-84988	Sagewash Sanitizer Jacketed Caplets Wysiwash Jacketed Caplets	calcium hypochlorite 68%
Arch Chemicals Inc.	Alliance Trading Inc.	HTH Granular 73	1258-1239-42177	Refresh + Super Shockwave Shock Treatment for Swimming Pools	calcium hypochlorite 73%
Arch Chemicals Inc.	In the Swim	HTH Granular 73	1258-1239-51432	In the Swim Super Pool Shock	calcium hypochlorite 73%
Arch Chemicals Inc.		HTH Granular 75	1258-1170	HTH Calcium Hypochlorite Granular 75 HTH Kiddie Pool Sanitizer	calcium hypochlorite 78%

Manufacturer	Registrant, if different from Manufacturer	Label Description	EPA Registration Number	Trade Name(s) as Appear(s) on Minnesota Department of Agriculture Registration List	Active Ingredient
Arch Chemicals Inc.		HTH Pool Shock	1258-1237	HTH Chlorinating Granules HTH Chlorinating Granules Chlorinator HTH Pop Up Pool Start Up & Maintenance Kit HTH Reliable Cleaning Granules Chlorinator HTH Shock N Swim HTH Sock It Shock N Swim Shock Treatment HTH Spa Chlorinating Sanitizer HTH Spa Shock HTH Spa Shock for Spas and Hot Tubs HTH Vinyl Pool Shock HTH Winterizing Pool Closing Shock	calcium hypochlorite 47.6%
Arch Chemicals Inc.	Alliance Trading Inc.	HTH Pool Shock	1258-1237-42177	Pureshock Shock Treatment for Swimming Pools	calcium hypochlorite 47.6%
Arch Chemicals Inc.	GLB Pool & Spa	HTH Pool Shock	1258-1237-7364	GLB Super Charge II	calcium hypochlorite 47.6%
Arch Chemicals Inc.	Qualco Inc.	HTH Pool Shock	1258-1237-3525	Guardian Chlorinating Granules	calcium hypochlorite 47.6%
Arch Chemicals Inc.		Pace Super Chlorinator & Shock Treatment	1258-782	Pool Breeze Pool Care System Shock Treatment and Superchlorinator	calcium hypochlorite 68%

Manufacturer	Registrant, if different from Manufacturer	Label Description	EPA Registration Number	Trade Name(s) as Appear(s) on Minnesota Department of Agriculture Registration List	Active Ingredient
Arch Chemicals Inc.		Pulsar II Dry Chlorinator Tablets 65	1258-1179	Calcium Hypochlorite Plus Tablet Constant Chlor Plus Cal Hypo Briquettes for Municipal & Industrial Water Treatment Dry Tec Cal Hypo Briquettes for Municipal & Industrial Water Treatment Applications Drytec Briquettes Pulsar Plus Calcium Hypochlorite Briquettes for Commercial Swimming Pool Use Pulsar Plus Dry Chlorinator Briquettes	calcium hypochlorite 66%
Arch Chemicals Inc.		Sock It, Shock Treatment & Superchlorinator for Swimming Pools	1258-913	HTH Poolife Rapid Shock Shock Treatment HTH Sock It Fast Action Shock Treatment	calcium hypochlorite 68%
Arch Chemicals Inc.	In the Swim	Sock It, Shock Treatment & Superchlorinator for Swimming Pools	1258-913-51432	In the Swim Calcium Hypochlorite In the Swim Pool Shock	calcium hypochlorite 68%
Arch Chemicals Inc.		Sodium Hypochlorite 10	1258-1094	HTH Liquid Chlorinator	sodium hypochlorite 10%
B & B Chlorination		Calcium Hypochlorite Hydrated	53026-1	Calcium Hypochlorite Mixture Pellet Form	calcium hypochlorite 73%
Champion Packaging & Distributing Inc.		Sodium Hypochlorite Solution	55852-3	Champion Pool Shock 12.5% Pro-Clor Pool Shock 12.5%	sodium hypochlorite 12.5%
Clorox Co.		Ultra Clorox Brand Regular Bleach	5813-50	Clorox Regular Bleach Ultra Clorox Regular Bleach	sodium hypochlorite 6.0%
Clorox Professional Products Co.		CPPC Bleach	67619-1	Commercial Solutions Clorox Germicidal Bleach	sodium hypochlorite 5.25%

Manufacturer	Registrant, if different from Manufacturer	Label Description	EPA Registration Number	Trade Name(s) as Appear(s) on Minnesota Department of Agriculture Registration List	Active Ingredient
Clorox Professional Products Co.		CPPC Ultra Bleach 2	67619-8	Clorox Commercial Solutions Ultra Clorox Germicidal Bleach Commercial Solutions Ultra Clorox Germicidal Bleach I	sodium hypochlorite 6.15%
DPC Industries Inc.		Dixichlor	813-16	Dixichlor Sodium Hypochlorite 10.0	sodium hypochlorite 10%
DPC Industries Inc.		Dixichlor Lite	813-14	Dixichlor Lite Sodium Hypochlorite 5.25	sodium hypochlorite 5.25%
DPC Industries Inc.		Dixichlor Max	813-15	Dixichlor Max Sodium Hypochlorite 12.5	sodium hypochlorite 12.5%
DPC Industries Inc.	Chaska Chemical Co. Inc.	Dixichlor Max	813-15-7350	Sani-Chlor	sodium hypochlorite 12.5%
DPC Industries Inc.	Water Engineering Inc.	Dixichlor Max	813-15-68314	Formula 10	sodium hypochlorite 12.5%

Manufacturer	Registrant, if different from Manufacturer	Label Description	EPA Registration Number	Trade Name(s) as Appear(s) on Minnesota Department of Agriculture Registration List	Active Ingredient
Ecolab Inc.		XY-12	1677-52	Aqua Balance Pool and Spa Disinfectant Eco-Clean Elite Low Temperature Machine Sanitizer Eco-San Liquid Sanitizer Equipment Sanitizer Ful-Bac Liquid Sanitizer Keystone Sanitizer Maxxum 700 Monarch Liquid Monoklor Liquid Sanitizer PC-San 581 Phase 1 Sanitizer Poultry Care E Liquid Sanitizer Pristine Pristine-M Pristine QB Pristine QF Pristine QM Pristine QP Quadexx 700 Quantum E Liquid Sanitizer Ultra San Liquid Machine Sanitizer XY-12 Liquid Sanitizer XY-12-P	sodium hypochlorite 8.4%



Manufacturer	Registrant, if different from Manufacturer	Label Description	EPA Registration Number	Trade Name(s) as Appear(s) on Minnesota Department of Agriculture Registration List	Active Ingredient
Ecolab Inc.	Meda Inc.	XY-12	1677-52-65817	Chem-Star Shield 840 Liquid Sanitizer	sodium hypochlorite 8.4%
Ecolab Inc.	Puritan Services Inc.	XY-12	1677-52-541	Clean Force Low-Temp Sanitizer Quintet Chlorine Sanitizer	sodium hypochlorite 8.4%
GE Osmonics Inc.		Chlorinating Tablets	50510-1	Chlorinating Tablets	calcium hypochlorite 72%
Hawkins Inc.		Azone	7870-1	Azone Disinfectant	sodium hypochlorite 10%
Hawkins Inc.	Chaska Chemical Co. Inc.	Azone	7870-1-7350	Chlor-10 Hypochlorite Solution	sodium hypochlorite 10%
Hawkins Inc.	Custom Pools Inc.	Azone	7870-1-63054	Custom Chlor Disinfectant	sodium hypochlorite 10%
Hawkins Inc.	Horizon Chemical Co. Inc.	Azone	7870-1-69385	Liquid Chlorine Sanitizer-Disinfectant	sodium hypochlorite 10%
Hawkins Inc.	Lynde Co.	Azone	7870-1-70606	Lynde-Chlor	sodium hypochlorite 10%
Hawkins Inc.	Ver Tech Labs	Azone	7870-1-70732	Low Temp Sanitizer	sodium hypochlorite 10%
Hawkins Inc.		Azone 15	7870-5	Azone 15	sodium hypochlorite 12.5%
Hawkins Inc.	Chaska Chemical Co. Inc.	Azone 15	7870-5-7350	Chlor-12	sodium hypochlorite 12.5%
Hydrite Chemical Co.		Sodium Hypochlorite 10%	2686-17	Sodium Hypochlorite 10%	sodium hypochlorite 10%
Hydrite Chemical Co.	Commercial Pool & Spa Supplies Inc.	Sodium Hypochlorite 10%	2686-17-64341	Commercial Chlor	sodium hypochlorite 10%
Hydrite Chemical Co.		Sodium Hypochlorite 12.5%	2686-20001	San-I-King No. 451 Liquid Sodium Hypochlorite Sodium Hypochlorite 12.5%	sodium hypochlorite 12.5%
Hydrite Chemical Co.	U.S. Water Services	Sodium Hypochlorite 12.5%	2686-20001-71675	Ucide 110	sodium hypochlorite 12.5%
Hydrite Chemical Co.	Utility Chemicals Inc.	Sodium Hypochlorite 12.5%	2686-20001-39526	Ucide 110	sodium hypochlorite 12.5%
James Austin Co.		Austin A-1 Ultra Disinfecting Bleach	1672-65	Austin A-1 Ultra Disinfecting Bleach	sodium hypochlorite 6.0%

Manufacturer	Registrant, if different from Manufacturer	Label Description	EPA Registration Number	Trade Name(s) as Appear(s) on Minnesota Department of Agriculture Registration List	Active Ingredient
James Austin Co.	Sherwin Williams Co.	Austin's Sodium Hypochlorite	1672-20001-577	Sherwin-Williams Pro Clean Mildew Eliminator	sodium hypochlorite 12.5%
Jiangnan Salt and Chemical Complex		Super-Chlor	74831-20005	Superchlor	calcium hypochlorite 65%
JohnsonDiversey Inc.	DiverseyLever	Sodium Hypochlorite	875-93	Divosan Hypochlorite	sodium hypochlorite 5.25%
K.A. Steel Chemicals Inc.		Sodium Hypochlorite Solution	33981-20001	Sodium Hypochlorite Solution	sodium hypochlorite 12.5%
K.A. Steel Chemicals Inc.	Rochester Midland Corp.	Sodium Hypochlorite Solution	33981-20001-527	Chlorguard II	sodium hypochlorite 12.5%
K.A. Steel Chemicals Inc.	Saratoga Specialties	Sodium Hypochlorite Solution	33981-20001-9409	Pro-Chlor 12.5	sodium hypochlorite 12.5%
K.A. Steel Chemicals Inc.	Stearns Packaging Corp.	Sodium Hypochlorite Solution	33981-20001-3640	Hypo-Chlor Formula 12.5	sodium hypochlorite 12.5%
K.A. Steel Chemicals Inc.	Garratt Callahan Co.	Sodium Hypochlorite Solution 10%	33981-20002-8540	Formula 308	sodium hypochlorite 10%
K.A. Steel Chemicals Inc.	Nyco Products Co.	Sodium Hypochlorite Solution 5.25%	33981-20004-8370	Chlorine Sanitizer II	sodium hypochlorite 5.25%
KIK International Inc.		Lasso Bleach / Pure Bright Disinfectant Bleach	70271-3	Pure Bright Disinfectant Bleach	sodium hypochlorite 5.25%
KIK International Inc.		Pure Bright 10% Sodium Hypochlorite Solution	70271-10	Shock	sodium hypochlorite 10%
KIK International Inc.		Pure Bright Germicidal Ultra Bleach	70271-13	Hi-Lex Bleach Regular Scent Pure Bright Germicidal Ultra Bleach Red Max Germicidal Bleach	sodium hypochlorite 6.0%
KIK International Inc.	Dolgenercorp Inc.	Pure Bright Germicidal Ultra Bleach	70271-13-63546	American Value Bleach	sodium hypochlorite 6.0%
KIK International Inc.	Family Dollar Services Inc.	Pure Bright Germicidal Ultra Bleach	70271-13-40020	Family Dollar Bleach	sodium hypochlorite 6.0%
KIK International Inc.	Food Services of America	Pure Bright Germicidal Ultra Bleach	70271-13-75270	Essentials Ultra Germicidal Bleach	sodium hypochlorite 6.0%

Manufacturer	Registrant, if different from Manufacturer	Label Description	EPA Registration Number	Trade Name(s) as Appear(s) on Minnesota Department of Agriculture Registration List	Active Ingredient
KIK International Inc.	Inter American Products Inc.	Pure Bright Germicidal Ultra Bleach	70271-13-8601	Everyday Living Bleach Regular	sodium hypochlorite 6.0%
KIK International Inc.	K Mart Corp.	Pure Bright Germicidal Ultra Bleach	70271-13-24908	American Fare Bleach Regular Scent	sodium hypochlorite 6.0%
KIK International Inc.	Save A Lot Ltd	Pure Bright Germicidal Ultra Bleach	70271-13-74249	Axis Ultra Bleach	sodium hypochlorite 6.0%
KIK International Inc.	Target Corp.	Pure Bright Germicidal Ultra Bleach	70271-13-13344	Bleach Regular	sodium hypochlorite 6.0%
Krudico Inc.	Iron Out Inc.	Calcium Hypochlorite 70% Dry Chlorinating Pellets / Pell-Chlor Rounded for Dry Pellet Chlorinators	55304-1-9902	Filter-Mate Chlorine Pellets	calcium hypochlorite 70%
Krudico Inc.	Pro Products LLC	Calcium Hypochlorite 70% Dry Chlorinating Pellets / Pell-Chlor Rounded for Dry Pellet Chlorinators	55304-1-73529	Pro Chlor Pel	calcium hypochlorite 70%
Olin Corp.	Pioneer Americas LLC	Sodium Hypochlorite - 12.5	72315-6	Sodium Chlorite - 12.5 Bacticide	sodium hypochlorite 12.5%
OnLine Packaging Inc.	Aldi Inc. Minnesota	SoWhite Brand Ultra Bleach and Disinfectant	9009-16-73664	Tundra Ultra Bleach	sodium hypochlorite 6.0%
PPG Industries Inc.		Induchlor Calcium Hypochlorite Granules	748-239	Induclor Calcium Hypochlorite Granules	calcium hypochlorite 68%
PPG Industries Inc.	Univar USA Inc.	Induchlor Calcium Hypochlorite Granules	748-239-550	Vanguard Plus Calcium Hypochlorite Granules	calcium hypochlorite 68%
PPG Industries Inc.		Pittabs	748-138	Induclor Calcium Hypochlorite Tablets Pittabs Dry Chlorinating Tablets	calcium hypochlorite 68%
PPG Industries Inc.	Alliance Trading Inc.	Pittchlor	748-217-42177	Refresh Dry Chlorinating Granular for Swimming Pools Regal Calcium Hypochlorite Granules	calcium hypochlorite 68%
PPG Industries Inc.	Harcros Chemicals Inc.	Pittchlor	748-217-148	Freestyle Calcium Hypochlorite 65	calcium hypochlorite 68%

Manufacturer	Registrant, if different from Manufacturer	Label Description	EPA Registration Number	Trade Name(s) as Appear(s) on Minnesota Department of Agriculture Registration List	Active Ingredient
PPG Industries Inc.		PPG 70 Cal Hypo Granules	748-296	Induclor 70 Zappit 73 Calcium Hypochlorite Granules	calcium hypochlorite 73%
PPG Industries Inc.	Better Water Industries Inc.	PPG 70 Cal Hypo Granules	748-296-58673	BWI Chlorinating Granules	calcium hypochlorite 73%
PPG Industries Inc.	Iron Out Inc.	PPG 70 Cal Hypo Granules	748-296-9902	Filter-Mate Saniwell Chlorinating Granules	calcium hypochlorite 73%
PPG Industries Inc.		PPG Calcium Hypochlorite Tablets	748-295	Accu-Tab SI Calcium Hypochlorite Tablets	calcium hypochlorite 68%
PPG Industries Inc.	Ecolab Inc.	PPG Calcium Hypochlorite Tablets	748-295-1677	7000 Dry Chlorinating Tablets	calcium hypochlorite 68%
PPG Industries Inc.	Better Water Industries Inc.	PPG Chlorinating Pellets	748-297-58673	Calcium Hypochlorite Hydrated	calcium hypochlorite 73%
PPG Industries Inc.	Iron Out Inc.	PPG Chlorinating Pellets	748-297-9902	Filter-Mate Saniwell Chlorinating Pellets	calcium hypochlorite 73%
Rowell Chemical Corp.	Twinco Romax	Hypo 150	67649-20001-73785	Ultra Shock	sodium hypochlorite 12.5%
Seychelle Environmental Technologies Inc.		Pell-Chlor Drinking Water Disinfecting Tablets	83610-1	Redi Chlor Water Disinfection Tablets	calcium hypochlorite 70%
Surpass Chemical Co. Inc.	Oakite Products Inc.	Surchlor	9359-2-1020	Liquid Bactericide	sodium hypochlorite 12.5%
Sysco Corp.		SYSCO Reliance Ultra Disinfectant Bleach	29055-3	Sysco Reliance Ultra Disinfectant Bleach	sodium hypochlorite 6.0%
Tetradyne LLC	Boumatic LLC	Coresan 12.5	73073-2-75682	Tru-Blu Chlor 125	sodium hypochlorite 12.5%
U.S. Chemical Corp.		San-I-Queen Liquid Sodium Hypochlorite	7546-3	U.S. Sanitizer E.S. Liquid Sodium Hypochlorite U.S.C. ES-III Liquid Sodium Hypochlorite	sodium hypochlorite 6.4%
U.S. Chemical Corp.	Food Services of America	San-I-Queen Liquid Sodium Hypochlorite	7546-3-75270	Essentials Dishmachine Low Temperature Sanitizer	sodium hypochlorite 6.4%
U.S. Chemical Corp.	Gordon Food Service Inc.	San-I-Queen Liquid Sodium Hypochlorite	7546-3-45133	Sanitizer E.S.	sodium hypochlorite 6.4%

Manufacturer	Registrant, if different from Manufacturer	Label Description	EPA Registration Number	Trade Name(s) as Appear(s) on Minnesota Department of Agriculture Registration List	Active Ingredient
U.S. Chemical Corp.	Independent Marketing Alliance	San-I-Queen Liquid Sodium Hypochlorite	7546-3-75686	Low Temp Chlorinated Sanitizer	sodium hypochlorite 6.4%
U.S. Chemical Corp.	Professional Service & Supply Inc.	San-I-Queen Liquid Sodium Hypochlorite	7546-3-85192	Pro-Serv Flash CL	sodium hypochlorite 6.4%
Univar USA Inc.		Liquichlor 10.0% Solution	550-197	Liquichlor 10% Solution	sodium hypochlorite 10%
Univar USA Inc.		Liquichlor 12.5% Solution	550-198	Liquichlor 12.5% Solution	sodium hypochlorite 12.5%
Univar USA Inc.	PPG Industries Inc.	Liquichlor 12.5% Solution	550-198-748	Chemchlor	sodium hypochlorite 12.5%
Univar USA Inc.		Liquichlor 5.25% Solution	550-199	Liquichlor 5.25% Solution	sodium hypochlorite 5.25%
Vertex Chemical Corp.	Anderson Chemical Co.	Vertex Concentrate	9616-8-150	Reg 10	sodium hypochlorite 10%
Vertex Chemical Corp.		Vertex CSS-12	9616-7	Vertex CSS-12	sodium hypochlorite 12.5%
Vertex Chemical Corp.	Anderson Chemical Co.	Vertex CSS-12	9616-7-150	Halt	sodium hypochlorite 12.5%
Vertex Chemical Corp.	Hillyard Industries Inc.	Vertex CSS-12	9616-7-67941	Halt	sodium hypochlorite 12.5%
Vertex Chemical Corp.	Horizon Chemical Co. Inc.	Vertex CSS-12	9616-7-69385	Horizon Liquefied Chlorinator	sodium hypochlorite 12.5%
Vertex Chemical Corp.		Vertex CSS-5 Bleach	9616-10	Vertex CSS-5 Bleach	sodium hypochlorite 5.25%
Vertex Chemical Corp.	Anderson Chemical Co.	Vertex CSS-5 Bleach	9616-10-150	Lo-Temp Chlorinating Sanitizer Surfex Series	sodium hypochlorite 5.25%
Vertex Chemical Corp.	Hillyard Industries Inc.	Vertex CSS-5 Bleach	9616-10-67941	Lo-Temp Chlorinating Sanitizer	sodium hypochlorite 5.25%
West Agro Inc.		Chemland Extract-2	4959-47	Extract 2	sodium hypochlorite 12.5%

<sup>1</sup> Amendments to Minnesota Rules, Chapter 4725, effective August 4, 2008, require that chlorine materials used for well disinfection must meet the requirements of ANSI/NSF Standard 60-2003e as determined by a person accredited by the ANSI under ANSI Standard Z34.1-1993 or be registered by the United States Environmental Protection Agency in accordance with the Federal Insecticide, Fungicide, and Rodenticide Act (FIFRA) sec. 3(c)(7)(A) as an antimicrobial pesticide for use in potable water. Chlorine compounds with additives such as perfumes or algaecides must not be used for disinfection. The amended rule also allows the use of an alternate disinfection material if the material is a biocide meeting the material and use standards of this part, and provides biocidal activity equivalent to the chlorine concentrations and contact times required in this part.

Annual renewal of product registrations at the MDA begins in January. Many products listed here were registered in 2008 and are currently in the renewal process for 2009. End users may continue to use previously registered products they have on hand. A manufacturer may not sell new product unless the registration is current.

This list is generated from listings found on <http://state.ceris.purdue.edu/doc/mn/statemn.html>. Listings are found by clicking on “Search Minnesota Pesticide Data”, selecting “Site of Application”, entering keyword “potable”, and selecting “Human Drinking Water Systems (Potable)”.

Only those products labeled specifically for well disinfection are included in this list of MDH Well Management Section approved products [177 of 550 total products listed on website for “Human Drinking Water Systems (Potable)”].

Many sodium chlorite, sodium chlorate, chlorine dioxide, and chlorine gas products are listed for use in disinfection of water supplies and/or water storage systems, but are not labeled for use in well disinfection, and should not be used for well disinfection. (Sodium chlorite ( $\text{NaClO}_2$ ) and sodium chlorate ( $\text{NaClO}_3$ ) are used to generate chlorine dioxide.)

Some calcium hypochlorite and sodium hypochlorite products are on U.S. EPA's list, but are not labeled for well disinfection, so do not appear on this list, and should not be used for well disinfection.

**PITLESS ADAPTERS AND UNITS**  
**January 2009**

The following equipment meets the requirements of Minnesota Rules, Chapter 4725, for use with a well or boring casing or casing extension terminating at least 12 inches above grade.

**ADVANCE (DAVE LUDWIG INDUSTRIAL SALES)**

Weld-on Adapter Kit (Submersible Only)  
21-inch Single Model (Threaded Connections, Submersible Only)

**BAKER MANUFACTURING / MONITOR DIVISION**

PS Welded, Threaded, and Kwikonect Pitless Units  
DQ Series Pitless Kit  
PJ Shallow Well Pitless Unit for Concentric Piping  
PJ Single Pipe Deep Well Pitless Unit  
Snappy Pitless Adapter (galvanized cast iron)  
Snappy Pressurized Pitless Adapter  
Bulldog Pitless Adapter (brass)  
BEZ Weld on Pitless Adapter (approved 5-27-05)  
PJ Double Pipe Deep Well Pitless Unit [**Out of Production**]  
Snappy Weld-on Pitless Adapter [**Out of Production**]  
Monitor 5 X 6 Fiberloc Polymer Composites Pitless Kit [**Out of Production**]

**HARCO**

Pitless Pump Installation (bench welded only) [**Out of Production**]

**MAASS MIDWEST**

Model J Weld-on Adapter  
Model B Weld-on Adapter  
Model JC Clamp-on Adapter (Submersible Only)  
Model JJ Weld-on Adapter with Concentric Piping for Shallow Well Pump  
Model JX Pitless Unit  
Model BX Pitless Unit  
Model MB Pitless Unit  
Model CW and CW-WA Series Adapters (approved 6-28-95)

**MERRILL**

SP and SPP Pitless Units  
SPK Clamp-on Pitless Kit (Submersible Only)  
MCK Brass Clamp-on Pitless Kit (approved 12-8-95)  
Two-Pipe Jet Unit [**Out of Production**]  
E-Z Pull Weld-on (Submersible Only) [**Out of Production**]

**PAULUS PLASTIC COMPANY**

Clear Way Plastic Adapter (approved 12-7-95)

**WELLS, INC.**

Safety-Seal Clamp-on Unit  
Aqua Seal, T-Series and B-Series (approved 12-7-95)  
Weld-on Unit (Submersible Only) [**Out of Production**]

## **WHITEWATER**

Whitewater Pitless Unit SU (Plain End, Threaded, and Compression Fitting)  
Duplex Type 1060 Sub (Thread to Casing)  
Duplex Type 2070 Sub  
Duplex Type 2015 Sub (Thread to Casing)  
Duplex Type 1060 J-C Deep Well 2-Pipe with Concentric Piping  
Duplex Type 1060 SW Shallow Well  
Duplex Type 1060 PJ-C Deep Well Single Pipe with Concentric Piping  
SS2 Shallow Well Jet Unit  
1J2 Deep Well Jet Unit with Concentric Piping  
Pitless Adapter Tank (PAT) with ¼-inch Wall  
Whitewater/Morrison Pitless Adapter-Seal Model D-8001 (Above Ground Discharge)  
Whitewater/Morrison Pitless Adapter-Seal Model DWC-008A (Above Ground Discharge)  
Ace Pressurized Clamp-on (Submersible Only) **[Out of Production]**  
Ace Weld-on (Submersible Only) **[Out of Production]**  
Duplex Type 2000 PJ2-C Single Pipe Packer w/ Concentric Piping - Backtapped **[Out of Production]**  
Duplex Type 2000 PJ3-C Single Pipe Packer w/ Concentric Piping - Backtapped **[Out of Production]**  
Duplex Type 2000 SW Shallow Well - Backtapped **[Out of Production]**

## **WILLIAMS**

Clamp-on Saddle (Submersible Only) **[Out of Production]**

Well Cap Note – All regulated wells and borings must have a permanent watertight and vermin-proof cap installed on the casing (the innermost casing, if the well or boring has multiple casings). The cap must be an overlapping well cap with compression gasket, a threaded or welded well cap, a sanitary well seal, or the extension of the casing at least 1 inch into the base of a pump. The screened vent required for a water-supply well may be incorporated into the underside of the well cap.

Casing Connection Note – A pitless unit that connects to the well casing with a compression seal must provide for the well casing to extend at least 2.5 inches into the throat of the pitless unit.



**BURIED PRESSURE TANKS**  
**January 2009**

The following buried pressure tanks meet the requirements of Minnesota Rules, chapter 4725.

**AMTROL**

Well X-Trol UG Models

**BAKER**

TU62VWF [Out of Production]

TUVWM [Out of Production]

**MORRISON**

Wisconsin Code Tank [Out of Production]

**WELLMATE PENTAIR WATER (Structural Fibers)**

WM Series

Low Profile Series

**WESSELS**

Buried Type

**WHITEWATER**

Pitless Adapter Tank (PAT) with 1/4 inch Wall

Note: Other pressure tanks not listed here may also be used as a buried or partially buried tank with a water-supply well if the tank meets the requirements of Minnesota rules, part 4725.5350, subpart 2:

- A. The tank must be identified with the manufacturer's name, a serial number, the allowable working pressure, and the year fabricated;
- B. The tank must have an interior coating that complies with ANSI/NSF Standard 61-2003e if the tank has an interior coating in contact with water;
- C. The tank must have a minimum one-fourth inch wall thickness for a steel pitless adapter tank attached directly to the well casing;
- D. The tank must have all connections to the pressure tank welded or threaded; and
- E. The tank must be installed above the water table.

## Protective Manhole Covers For At-Grade Wells October 2010

The following covers have been verified by the following companies to meet the AASHTO Standards H20-44 and M306-04:

Manufacturer	Model Number, Description	Diameter, inches		Cover Material
		Cover	Inside	
Baker Manufacturing	HE812CS (Out of Production)		8	Cast Iron
Bresnahan Foundry	00068	6.31		Aluminum
Century Products, Inc.	0-MH1012A (Out of Production)		8.5	Aluminum
Emco Wheaton Retail Corp.	A0721, 6-inch bolt-down	6	4.25	Ductile Iron
	A0721, 8-inch bolt-down	9	6.0	Ductile Iron
	A0721, 12-inch bolt-down	12.5	9.4	Ductile Iron
	A0721, 18-inch bolt-down	18	13.8	Ductile Iron
Fairfield Industries, Inc.	120 MW	12.3		Cast Iron
Griffin Industries Corp.	Ace 7191 (Out of Production)		8.1	Aluminum
Kenner Well Cover Co.	Sherwood		5	Aluminum
	Sherwood		8	Aluminum
Lyc0 Enterprises, Inc.	7-10BS	5.88		Cast Iron
	JM-812 "Heavyweight"	7.88		Cast Iron
	8-B	8.50		Cast Iron
	12-B	11.25		Cast Iron
Martin Products, Inc.	MWL5006, 5-inch, 2 bolts	5.25	4.25	Cast Iron
	MWL8012, 8-inch, 3 bolts	8.37	7.25	Cast Iron
Morris Industries, Inc.	318101220	8.44		Cast Iron
	318131220	12		Cast Iron
Morrison Bros. Co.	8" 418XA and 418XAW	8.19		Cast Iron
	9" 418XA and 418XAW	8.88		Cast Iron
Neenah Foundry Co.	R-6460-C	27	23.5	Cast Iron
	R-6460-D	29	27	Cast Iron
	R-6461-AH and R-6462-AH	10.25	6.5	Cast Iron
	R-6461-CH and R-6462-CH	16.25	12.5	Cast Iron
	R-6461-DH and R-6462-DH	18.25	14.5	Cast Iron
	R-6461-FH and R-6462-FH	25.25	21.5	Cast Iron
	R-6461-GH and R-6462-GH	28.25	24.5	Cast Iron
	R-6461-HH and R-6462-HH	34.25	30.5	Cast Iron
	R-6461-JH and R-6462-JH	40	36.5	Cast Iron
	R-6461-KH and R-6462-KH	45.88	42.5	Cast Iron
	R-6464-F	26	24	Cast Iron
	R-6464-G	29	27	Cast Iron
	Wagner Manufacturing	015 (8-inch diameter)		

These manholes have been determined to meet the requirements in Minnesota Rules, part 4725.6850, and are approved for use in at-grade construction of monitoring wells, remedial wells, dewatering wells, and environmental bore holes in Minnesota. Manhole covers or vaults not appearing on this list may not be used unless and until the Minnesota Department of Health has verified that the cover or vault meets the rule requirements.

**End  
of  
Appendix: Index, Materials Section**

**VARIANCES: SELECTED EXCERPTS**  
**CHAPTER 4717 (2009)**  
**DEPARTMENT OF HEALTH**  
**ENVIRONMENTAL HEALTH RULES**

**4717.7000 VARIANCE REQUEST.**

Subpart 1. **Request.** A party may ask the commissioner of health to grant a variance from the following rules:

...  
N. wells and borings, parts 4725.0100 to 4725.7450;  
...

Subp. 2. **Procedures for requesting a variance.** The procedures in this subpart apply to a request for a variance of the rules specified in subpart 1. Additional procedures may be specified in the rules listed in subpart 1 which also must be complied with. The party requesting the variance must submit the variance request in writing to the commissioner of health along with any applicable fee. A request must contain:

- A. the specific language in the rule or rules from which the variance is requested;
- B. the reasons why the rule cannot be met;
- C. the alternative measures that will be taken to assure a comparable degree of protection to health or the environment if a variance is granted;
- D. the length of time for which the variance is requested;
- E. a statement that the party applying for the variance will comply with the terms of the variance, if granted; and
- F. other relevant information the commissioner determines necessary to properly evaluate the request for the variance.

Subp. 3. **Applicant for a variance.** The applicant for a variance must be the party to whom the rule specified in subpart 1 applies.

STAT AUTH: MS s 14.05; 31.101; 31.11; 103I.101; 103I.221; 103I.301; 103I.621; 144.05; 144.08; 144.12; 144.123; 144.383; 144.9508; 145A.02; 157.01; 157.011; 157.04; 157.08; 157.09; 157.13; 326.70 to 326.81

HIST: 15 SR 1597; 17 SR 2773; 19 SR 1419; 19 SR 1637; 20 SR 2765; 22 SR 314; 22 SR 668; 23 SR 519; 23 SR 1591; 26 SR 31; 28 SR 147; 29 SR 531; L 2007 c 140 art 13 s 3; 33 SR 1771

**4717.7010 CRITERIA FOR DECISION; CONDITIONS.**

- Subpart 1. **Criteria for granting a variance.** The commissioner may grant a variance if:
- A. the variance was requested in a manner prescribed by part 4717.7000;
  - B. the variance will have no potential adverse effect on public health, safety, or the environment;
  - C. the alternative measures to be taken, if any, are equivalent to or superior to those prescribed in the rule;
  - D. strict compliance with the rule will impose an undue burden on the applicant; and
  - E. the variance does not vary a statutory standard.

Subp. 2. **Conditions for variance.** In granting a variance the commissioner may attach conditions the commissioner determines are needed to protect public health, safety, or the environment.

Subp. 3. **Future effect.** A variance shall have only future effect.

STAT AUTH: MS s 14.05

HIST: 15 SR 1597

**4717.7020 NOTIFICATION OF DECISION.**

The commissioner of health shall notify the party in writing of the commissioner's decision to grant or deny the variance. If a variance is granted, the notification must specify the period of time for which the variance will be effective and the alternative measures or conditions, if any, the applicant must meet. If a variance is denied, the commissioner of health shall specify the reasons for the denial.

STAT AUTH: MS s 14.05

HIST: 15 SR 1597

**4717.7030 EFFECT OF ALTERNATIVE MEASURES OR CONDITIONS.**

Alternative measures or conditions attached to a variance have the force and effect of the applicable rule. If the party violates the alternative measures or conditions attached to the variance, the party is subject to the enforcement actions and penalties provided in the applicable law or rule. The party to whom a variance has been issued must notify the commissioner of health in writing within 30 days of any material change in the conditions upon which the variance was granted.

STAT AUTH: MS s 14.05

HIST: 15 SR 1597

**4717.7040 RENEWAL OF VARIANCE.**

A request for the renewal of a variance must be submitted to the commissioner of health in writing 30 days before its expiration date. Renewal requests must contain the information specified in part 4717.7000, subpart 2. The commissioner shall renew a variance if the party continues to satisfy the criteria contained in part 4717.7010 and demonstrates compliance with the alternative measures or conditions imposed at the time the original variance was approved. This provision does not apply if there has been any material change in the conditions upon which the variance was granted.

STAT AUTH: MS s 14.05

HIST: 15 SR 1597

**4717.7050 DENIAL, REVOCATION, OR REFUSAL TO RENEW; APPEALS.**

Subpart 1. **Action.** The commissioner shall deny, revoke, or refuse to renew a variance if the commissioner determines that the criteria in part 4717.7010 are not met.

Subp. 2. **Appeal procedure.** A party may appeal the denial, revocation, or refusal to renew a variance by requesting, in writing, a contested case hearing under the Administrative Procedure Act, Minnesota Statutes, Chapter 14, within 30 days of receipt of the notice to deny, revoke, or refuse to renew the variance.

STAT AUTH: MS s 14.05

HIST.15 SR 1597

**SELECTED EXCERPTS  
MINNESOTA RULES, CHAPTER 4715 (2009)  
MINNESOTA PLUMBING CODE**

**4715.0200 BASIC PLUMBING PRINCIPLES.**

This code is founded upon certain basic principles of environmental sanitation and safety through properly designed, acceptably installed and adequately maintained plumbing systems. Some of the details of plumbing construction may vary but the basic sanitary and safety principles desirable and necessary to protect the health of the people are the same everywhere. As interpretations may be required, and as unforeseen situations arise which are not specifically covered in this code, the twenty three principles which follow shall be used to define the intent.

- A. All premises intended for human habitation, occupancy, or use shall be provided with a potable water-supply which meets the requirements of the commissioner of health. Such water supply shall not be connected with unsafe water sources nor shall it be subject to the hazards of backflow or back-siphonage.

**4715.0310 USE OF PUBLIC SEWER AND WATER SYSTEMS REQUIRED.**

If a public sewer is accessible in a street or alley to a building or premises and the connection is feasible, liquid wastes from any plumbing system in that building must be discharged into the public sewer unless otherwise prohibited by this code or a local ordinance.

If a public water supply system is accessible, the water distribution system must be connected to it unless otherwise permitted by the administrative authority. A water well taken out of service because a person is connecting to a public water supply must either be maintained for a use such as irrigation, or sealed and abandoned in accordance with the Minnesota Water Well Construction Code. (Minnesota Rules, Chapter 4725).

If either a public sewer or water supply system or both are not available, an individual water supply or sewage disposal system, or both, conforming to the published standards of the administrative authority must be provided.

Every building must have its own independent connection with a public or private sewer, except that a group of buildings may be connected to one or more manholes which are constructed on the premises, and connected to a public or private sewer. These manholes must conform to the standards set by the local sewer authority.

**4715.0320 CONFORMANCE WITH CODE.**

Subpart 1. **Scope.** As provided in Minnesota Statutes, section 326.B.43, the Minnesota Plumbing Code applies to all new plumbing installations, including additions, extensions, alterations, and replacements connected to a water or sewage disposal system owned or operated by or for a municipality, institution, factory, office building, hotel, apartment building, or other place of business regardless of location or the population of the city or town in which it is located.

Subp. 2. **New buildings.** All plumbing materials and plumbing systems or parts thereof must be installed to meet the minimum provisions of this code.

Subp. 3. **Existing buildings.** In existing buildings or premises in which plumbing installations are to be altered, renovated, or replaced, the new materials and work must meet the provisions of this code. If the administrative authority finds that the full performance of bringing the work into compliance with all requirements of this code would result in exceptional or undue hardship by reason of excessive structural or mechanical difficulty, or impracticability, a deviation may be granted by the administrative authority only to the extent the deviation can be granted without endangering the health and safety of the occupants and the public.

#### **4715.1910 IDENTIFICATION OF POTABLE AND NONPOTABLE WATER.**

Subpart 1. **Identification methods.** In all buildings where dual water distribution systems, one potable water and other nonpotable water, are installed, each system shall be identified, either by color marking or metal tags.

Subp. 2. **Color marking.** When color marking is used, potable water lines should be painted green and nonpotable water lines should be painted yellow. This requirement may be met by painting three-inch wide bands green or yellow at intervals of not more than 25 feet and at points where piping passes through walls, floors, or roofs in which case the bands shall be applied to the piping on both sides of the walls and both above and below the floor or roof. Points of outlets for nonpotable water shall be marked with a tag or color coded.

Subp. 3. **Metal tags.** When tags are used, potable water lines shall be identified by three-inch-diameter metal tags bearing the legend "SAFE WATER" in letters not less than 1/2 inch in height.

Nonpotable water lines shall be identified by firmly attached metal tags having the shape of a 4-inch equilateral triangle bearing the legend "NONPOTABLE WATER" in letters not less than 7/16 inch in height.

As in the use of color bands, tags shall be attached to pipes at intervals of not more than 25 feet, and, at either side of points where pipes pass through walls and above and below points where pipes pass through floors or roofs.

#### **4715.2010 MINIMUM REQUIRED AIR GAP.**

Subpart 1. **Measurement.** The minimum required air gap shall be measured vertically from the lowest end of a potable water outlet to the flood rim or line of the fixture or receptacle into which it discharges.

Subp. 2. **Requirement.** The minimum required air gap shall be twice the effective opening of a potable water outlet unless the outlet is a distance less than three times the effective opening away from a wall or similar vertical surface in which cases the minimum required air gap shall be three times the effective opening of the outlet. In no case shall the minimum required air gap be less than shown in subpart 4.

Subp. 3. **Effect of walls, ribs, and similar obstructions.** Side walls, ribs, or similar obstructions do not affect air gaps when spaced from inside edge of spout opening a distance greater than three times the diameter of the effective opening for a single wall, or a distance greater than four times the diameter of the effective opening for two intersecting walls.

Vertical walls, ribs, or similar obstructions extending from the water surface to or above the horizontal plane of the spout opening require a greater air gap when spaced closer to the nearest inside edge of spout opening than specified in this subpart. The effect of three or more such vertical walls or ribs has not been determined. In such cases, the air gap shall be measured from the top of the wall.

**Subp. 4. Minimum air gaps for plumbing fixtures.**

Fixture	Minimum Air Gap	
	When Not Affected By Near Wall (1) (Inches)	When Affected By Near Wall (2) (Inches)
Lavatories and other fixtures with effective opening not greater than 1/2 inch diameter	1.0	1.50
Sink, Laundry trays, gooseneck bath faucets and other fixtures with effective openings not greater than 3/4 inch diameter	1.5	2.25
Over rim bath fillers and other fixtures with effective openings not greater than 1 inch diameter	2.0	3.0
Drinking water fountains	1.0	1.50
Effective openings greater than 1 inch	2x diameter of effective opening	3x diameter of effective opening

**4715.2020 DEVICES FOR THE PROTECTION OF THE POTABLE WATER SUPPLY.**

Approved devices or assemblies to protect against backflow and back-siphonage must be installed at any plumbing fixture or equipment where backflow or back-siphonage may occur and where a minimum air gap cannot be provided between the water outlet to the fixture or equipment and its flood level rim.

**4715.2030 APPROVAL OF DEVICES.**

Before any device or assembly for the prevention of backflow or back-siphonage is installed, it shall have first been certified by a recognized testing laboratory acceptable to the administrative authority. Devices or assemblies installed in a building potable water supply distribution system for protection against backflow shall be maintained in good working condition by the person or persons responsible for the maintenance of the system.

**4715.2100 BACKFLOW PREVENTERS.**

- A. Atmospheric vacuum breaker (AVB):
  - (1) Must be installed at least six inches above spill line (see special requirements in part 4715.2150);
  - (2) No possibility of back pressure permitted;
  - (3) Only permitted on discharge side of last control valve; and
  - (4) No more than eight hours of continuous line pressure permitted.
  
- B. Pressure vacuum breaker assembly (PVB):
  - (1) Must be installed at least 12 inches above spill line;
  - (2) No possibility of back pressure permitted; and
  - (3) Continuous line pressure permitted.



- C. Spill-proof vacuum breaker (SVB):
  - (1) Must be installed at least six inches above spill line;
  - (2) No possibility of back pressure permitted;
  - (3) Continuous line pressure permitted; and
  - (4) Field testable.
  
- D. Hose connection vacuum breaker (Hose VB):
  - (1) Required for threaded hose connections;
  - (2) Back pressure not permitted;
  - (3) Continuous line pressure not permitted; and
  - (4) Any new device must be field testable. Exception: a vacuum breaker installed as an integral part of a product, approved to a standard, and installed at the factory will not be required to be field testable.
  
- E. Double-check valve with intermediate atmospheric vent (DCVIAV):
  - (1) Permitted for low hazard with small pipe sizes;
  - (2) Back pressure permitted; and
  - (3) Continuous line pressure permitted.
  
- F. Reduced pressure zone backflow preventer assembly (RPZ):
  - (1) Any degree of hazard permitted;
  - (2) Back pressure permitted; and
  - (3) Continuous line pressure permitted.
  
- G. Double-check valve assembly (DCVA):
  - (1) Permitted only for nontoxic, low hazard installations with nuisance or aesthetic concern;
  - (2) Back pressure permitted; and
  - (3) Continuous line pressure permitted.

**4715.2110 TYPES OF DEVICES REQUIRED WHERE AN AIR GAP CANNOT BE PROVIDED<sup>1</sup>**

	RPZ	DCV		Only allowed where no back pressure is possible		
		IAV	DCVA	SVB or PVB	AVB	Hose VB
A. Boiler, other than one- or two-family residential	X					
B. Boiler, one- or two-family residential	X	X				
C. Car wash	X			X	X	
D. Carbonated beverage machine (postmix) (see part 4715.2163)	X					
E. Chemical line	X					
F. Chemical tank	X			X	X	
G. Chiller	X					
H. Cooling tower	X	X		X	X	
I. Dental units (separate assembly required for each unit)	X					
J. Dishwasher, commercial				X	X	
K. Fire sprinkler system <sup>2</sup>	X	X	X			
L. Flush tank (water closet, urinal, similar) (see part 4715.2150)	X			X	X	
M. Flush valve (water closet, urinal, similar) (see part 4715.2150)	X			X	X	
N. Food and beverage equipment or system	X	X	X	X	X	
O. Garbage can washer	X			X	X	
P. Glycol or other antifreeze system	X					
Q. Lab equipment	X			X	X	
R. Lab faucet				X		
S. Laundry machine, commercial	X	X		X	X	
T. Lawn, garden or greenhouse sprinkler system	X			X	X	
U. Operating, dissection, embalming or mortuary table (see part 4715.1950)	X			X	X	
V. Private potable water supply (where permitted by administrative authority)	X	X	X			
W. Private nonpotable water supply (where permitted by administrative authority)	X					
X. Process line	X	X				
Y. Process tank	X			X	X	
Z. RV dump station	X	X		X	X	
AA. Sewage treatment	X			X	X	
BB. Soap dispenser	X	X		X	X	
CC. Swimming pool, fountain, pond, baptistery, aquarium or similar	X	X		X	X	
DD. Threaded hose connections, including: hose bibs, hydrants, service sinks, laundry trays					X <sup>3</sup>	X
EE. Truck fill	X			X	X	
FF. Vacuum systems or aspirators	X			X	X	

<sup>1</sup> For installations not listed in this part, review with the Administrative Authority.

<sup>2</sup> Installations must comply with AWWA-M14, Chapter 6 (1990) except that the following statement is deleted from section 6.3: At any time where the fire sprinkler piping is not an acceptable potable water system material, there shall be a backflow-prevention assembly isolating the fire sprinkler system from the potable water system.

<sup>3</sup> A vacuum breaker installed as an integral part of a product approved to a standard does not require additional backflow prevention on the hose threads; the product must be constructed so that if the integral backflow preventer is removed, the remaining threads will not be hose thread type. An unprotected threaded hose connection must be protected against backflow by addition of a backflow preventer complying with ASSE 1052.

#### **4715.2120 LOCATION OF BACKFLOW PREVENTERS.**

Backflow and back-siphonage preventing devices must be located so as to be readily accessible, preferably in the same room with the fixture they serve. Installation in utility or service spaces, provided they are readily accessible, is also permitted.

The access area must provide enough space for testing and maintenance of the device. A backflow preventer must not be installed in a pit or other confined area subject to recurrent flooding. When a conductor pipe is provided from a backflow preventer drain, a visible air gap must be provided at the device. New installations of reduced pressure zone backflow preventers must be at least 12 inches, but not more than six feet, above the finished floor or ground level.

#### **4715.2440 DESIGN OF SUMPS.**

Subpart 1. **Construction.** Sumps and receiving tanks shall be constructed of poured concrete, metal, or other approved materials. If constructed of poured concrete, the walls and bottom shall be adequately reinforced and designed to acceptable standards. Metal sumps or tanks shall be of such thickness as to serve their intended purpose and shall be treated internally and externally to resist corrosion.

Subp. 4. **Covers.** Sumps and receiving tanks must be provided with gastight metal covers, except that float control or switch rods must operate without binding. The cover must be of a bolt and gasket type or equivalent manhole opening to permit access for inspection, repairs, and cleaning. Covers must be metal or other structurally-sound material that is water-resistant and impervious to moisture, and must be adequate to support anticipated loads in the area of use.

#### **4715.2820 METHOD OF TESTING.**

Subpart 1. **Testing.** The air tests shall be applied to the plumbing drainage system in its entirety or in sections. Sections which are found satisfactory need not be retested after completion of the entire system unless considered necessary by the proper administrative authority.

Subp. 2. **Rough plumbing.** The piping of plumbing drainage and venting systems shall be tested upon completion of the rough piping. The method of testing shall be specified by the designer and shall either be an air test or hydrostatic test as described in this subpart or an alternative test as approved by the administrative authority. The air test shall be made by attaching the air compressor or testing apparatus to any suitable opening and closing all other inlets and outlets to the system by means of proper testing plugs. Plaster of paris shall not be used in roof terminals. Air shall be forced into the system until there is a uniform pressure of five pounds per square inch on the portion of the system being tested. The pressure shall remain constant for 15 minutes without the addition of air.

The hydrostatic test for thermoplastic piping materials shall be conducted by tightly closing all openings in the entire system to be tested except the highest opening. The system shall be filled with water to the point of overflow. If the system is tested in sections, each opening shall be tightly plugged except the highest opening of the section under test. Each section shall be filled with water, but a section shall not be tested with less than ten foot head of water. In testing successive sections, at least the upper ten feet of the next preceding section shall be tested, so that no joint or pipe in the building, except the uppermost ten feet of the system, is subjected to a test of less than ten foot head of water. The water shall be kept in the system or in the portion under test for at least 15 minutes before inspection begins. The system shall be tight at all points.

In lieu of five pound air test, concrete manholes and sewer pipes may be tested by negative pressure in accordance with ASTM Standards C1214-92 and C1244-93.

**Subp. 2a. Exceptions.**

- A Testing is not required for:
- (1) Outside leaders;
  - (2) Perforated or open drain tile; or
  - (3) Portions of storm sewers located more than ten feet from buildings, more than ten feet from buried water lines, and more than 50 feet from water wells, and not passing through soil or water identified as being contaminated.
- B. Building storm sewers may be tested in accordance with the Hydrostatic Test Method from the City Engineers Association of Minnesota, except that an air test may be required for any section of the building storm sewer that passes through contaminated soils or contaminated water. The Hydrostatic Test Method, provisions H2 and H3, as specified in Standard Utilities Specifications for Watermain and Service Line Installation and Sanitary Sewer and Storm Sewer Installation, written and published by the City Engineers Association of Minnesota, 1988 edition, is incorporated by reference, is not subject to frequent change, and is available in the office of the commissioner of administration.

**Subp. 3. Finished plumbing.** After the plumbing fixtures have been set and their traps filled with water, their connections shall be tested and proven gas and water tight by plugging the stack openings on the roof and the building drain where it leaves the building, and air introduced into the system equal to the pressure of a one inch water column. Such pressure shall remain constant for the period of inspection without the introduction of additional air.

**Subp. 4. Conductor pipes.** Conductor pipes and their roof connections inside the building shall be tested with air. (See subpart 2.).

**Subp. 5. Test of water distribution system.** Upon the completion of a section or of the entire water distribution system, it shall be tested and proved tight with the use of air or water not less than the maximum working pressure under which it is to be used. If tested with water, the water used for the test shall be obtained from a potable source.

**Subp. 6. Material and labor for tests.** The equipment, material, power, and labor necessary for the inspection and test shall be furnished by the plumbing contractor.

**Subp. 7. Test plugs or caps.** Test plugs or caps for roof terminals must extend above or outside the end of the vent pipe to provide a visible indication for removal after the test has been completed.

**MINNESOTA DEPARTMENT OF HEALTH, CHAPTER 103I,  
WELLS, BORINGS AND UNDERGROUND USES  
2008**

- 103I.001 Legislative intent.
- 103I.005 Definitions.
- JURISDICTION OVER WELLS AND BORINGS**
- 103I.101 Powers and duties of commissioner of health.
- 103I.103 Waste prevention may be required.
- 103I.105 Advisory council on wells and borings.
- 103I.111 Local authority over wells and borings.
- 103I.112 Fee exemptions for state and local government.
- 103I.113 Applicability to mining activities.
- WELL CONSTRUCTION AND OWNERSHIP**
- 103I.115 Compliance with this chapter required.
- 103I.205 Well construction.
- 103I.208 Notification filing fees and permit fees.
- 103I.211 Inactive.
- 103I.221 Plastic casings.
- 103I.222 Inactive.
- 103I.231 Commissioner may order repairs.
- 103I.235 Real property sale; disclosure of location of wells.
- 103I.236 Well disclosure in Washington County.
- 103I.241 Action for well contamination.
- WELL SEALING**
- 103I.301 Well sealing requirements.
- 103I.311 Identification and sealing of wells on state property.
- 103I.315 Orders to seal wells and borings.
- 103I.321 Inactive.
- 103I.325 Landowner sealed well and boring liability.
- 103I.331 Inactive.
- 103I.335 Funding for persons to seal wells.
- 103I.341 Collection and enforcement of well sealing costs.
- 103I.345 Well and boring sealing account.
- ELEVATOR BORINGS**
- 103I.401 Elevator borings.
- ENVIRONMENTAL BORE HOLES**
- 103I.451 Environmental bore holes.

- LICENSING AND REGISTRATION**
- 103I.501 Licensing and regulation of wells and borings.
- 103I.505 Reciprocity of licenses and registrations.
- 103I.515 Licenses not transferable.
- 103I.521 Fees deposited with commissioner of finance.
- 103I.525 Well contractor's license; representative's certification.
- 103I.531 Limited well/boring contractor's license; Representative's certification.
- 103I.533 Inactive.
- 103I.535 Elevator boring contractor's license; representative's certification.
- 103I.541 Monitoring well contractor's registration; representative's certification.
- 103I.545 Registration of drilling machines and hoists required.
- EXPLORATORY BORINGS**
- 103I.601 Exploratory boring procedures.
- 103I.605 Submission of data from exploratory borings.
- GROUNDWATER THERMAL EXCHANGE DEVICES**
- 103I.621 Permits for groundwater thermal exchange devices.
- VERTICAL HEAT EXCHANGERS**
- 103I.641 Vertical heat exchangers.
- UNDERGROUND SPACE DEVELOPMENT**
- 103I.661 Mined underground space development.
- UNDERGROUND STORAGE OF GAS OR LIQUID**
- 103I.681 Permit for underground storage of gas or liquid.
- 103I.685 Abandonment of underground storage project.
- 103I.691 Certificate of use.
- ENFORCEMENT**
- 103I.701 Inactive.
- 103I.705 Inactive.
- 103I.711 Impounding of equipment.
- 103I.715 Criminal penalties.

**Minnesota Statutes 2009, Chapter 103I**  
**State of Minnesota**

**103I.001 LEGISLATIVE INTENT.**

This chapter is intended to protect the health and general welfare by providing a means for the development and protection of the natural resource of groundwater in an orderly, healthful, and reasonable manner.

**History:** 1989 c 326 art 3 s 1

**103I.005 DEFINITIONS.**

Subdivision 1. **Applicability.** The definitions in this chapter apply to this chapter.

Subd. 2. **Boring.** "Boring" means a hole or excavation that is not used to extract water and includes exploratory borings, environmental bore holes, vertical heat exchangers, and elevator shafts.

Subd. 2a. **Certified representative.** "Certified representative" means a person certified by the commissioner to represent a well contractor, limited well/boring contractor, monitoring well contractor, or elevator boring contractor.

Subd. 3. **Commissioner.** "Commissioner" means the commissioner of health.

Subd. 4. **Department.** "Department" means the Department of Health.

Subd. 4a. **Dewatering well.** "Dewatering well" means a nonpotable well used to lower groundwater levels to allow for construction or use of underground space. A dewatering well does not include:  
(1) an excavation 25 feet or less in depth for temporary dewatering during construction; or  
(2) a well used to lower groundwater levels for control or removal of groundwater contamination.

Subd. 5. **Drive point well.** "Drive point well" means a well constructed by forcing a pointed well screen, attached to sections of pipe, into the ground with the screen and casing forced or driven into the ground with a hammer, maul, or weight.

Subd. 6. **Elevator boring.** "Elevator boring" means a bore hole, jack hole, drilled hole, or excavation constructed to install an elevator hydraulic cylinder.

Subd. 7. **Elevator boring contractor.** "Elevator boring contractor" means a person with an elevator boring contractor's license issued by the commissioner.

Subd. 8. **Environmental bore hole.** "Environmental bore hole" means a hole or excavation in the ground that penetrates a confining layer or is greater than 25 feet in depth and enters or goes through a water bearing layer and is used to monitor or measure physical, chemical, radiological, or biological parameters without extracting water. An environmental bore hole also includes bore holes constructed for vapor recovery or venting systems. An environmental bore hole does not include a well, elevator shaft, exploratory boring, or monitoring well.

Subd. 9. **Exploratory boring.** "Exploratory boring" means a surface drilling done to explore or prospect for oil, natural gas, apatite, diamonds, graphite, gemstones, kaolin clay, and metallic minerals, including iron, copper, zinc, lead, gold, silver, titanium, vanadium, nickel, cadmium, molybdenum, chromium, manganese, cobalt, zirconium, beryllium, thorium, uranium, aluminum, platinum, palladium, radium, tantalum, tin, and niobium, and a drilling or boring for petroleum.

Subd. 10. **Explorer.** "Explorer" means a person with an explorer's license issued by the commissioner.

Subd. 11. **Groundwater thermal exchange device.** "Groundwater thermal exchange device" means a heating or cooling device that depends on extraction and reinjection of groundwater from an independent aquifer to operate.

Subd. 12. **Limited well/boring contractor.** "Limited well/boring contractor" means a person with a limited well/boring contractor's license issued by the commissioner. Limited well/boring contractor's licenses are issued for constructing, repairing, and sealing vertical heat exchangers; installing, repairing, and modifying pitless units and pitless adaptors, well casings above the pitless unit or pitless adaptor, well screens, or well diameters; constructing, repairing, and sealing drive point wells or dug wells; constructing, repairing, and sealing dewatering wells; sealing wells; and installing well pumps or

pumping equipment.

Subd. 13.[Repealed, 2005 c 106 s 68]

Subd. 14. **Monitoring well.** “Monitoring well” means an excavation that is drilled, cored, bored, washed, driven, dug, jetted, or otherwise constructed to extract groundwater for physical, chemical, or biological testing. “Monitoring well” includes a groundwater quality sampling well.

Subd. 15. **Monitoring well contractor.** “Monitoring well contractor” means a person who is registered by the commissioner to construct monitoring wells.

Subd. 16. **Person.** “Person” means an individual, firm, partnership, association, or corporation or other entity including the United States government, any interstate body, the state, and any agency, department, or political subdivision of the state.

Subd. 17. **Provisions of this chapter.** “Provisions of this chapter” means the sections in this chapter and rules adopted by the commissioner under this chapter.

Subd. 18.[Repealed, 1991 c 199 art 2 s 29; 1991 c 355 s 54]

Subd. 19.[Repealed, 1990 c 597 s 73]

Subd. 20. **Vertical heat exchanger.** “Vertical heat exchanger” means an earth-coupled heating or cooling device consisting of a sealed closed-loop piping system installed vertically in the ground to transfer heat to or from the surrounding earth with no discharge.

Subd. 20a. **Water-supply well.** “Water-supply well” means a well that is not a dewatering well or monitoring well and includes wells used:

- (1) for potable water supply;
- (2) for irrigation;
- (3) for agricultural, commercial, or industrial water supply;
- (4) for heating or cooling;
- (5) as a remedial well; and
- (6) for testing water yield for irrigation, commercial or industrial uses, residential supply, or public water supply.

Subd. 21. **Well.** “Well” means an excavation that is drilled, cored, bored, washed, driven, dug, jetted, or otherwise constructed if the excavation is intended for the location, diversion, artificial recharge, or acquisition of groundwater. Well includes monitoring wells, drive point wells, and dewatering wells. “Well” does not include:

- (1) an excavation by backhoe, or otherwise for temporary dewatering of groundwater for nonpotable use during construction, if the depth of the excavation is 25 feet or less;
- (2) an excavation made to obtain or prospect for oil, natural gas, minerals, or products of mining or quarrying;
- (3) an excavation to insert media to repressure oil or natural gas bearing formations or to store petroleum, natural gas, or other products;
- (4) an excavation for nonpotable use for wildfire suppression activities; or
- (5) borings.

Subd. 22. **Well disclosure certificate.** “Well disclosure certificate” means a certificate containing the requirements of section 103I.235, subdivision 1, paragraph (j).

Subd. 23. **Well contractor.** “Well contractor” means a person with a well contractor's license.

Subd. 23a. **Well that is in use.** A “well that is in use” means a well that operates on a daily, regular, or seasonal basis. A well in use includes a well that operates for the purpose of irrigation, fire protection, or emergency pumping.

Subd. 24. **Wellhead protection area.** “Wellhead protection area” means the surface and subsurface area surrounding a well or well field that supplies a public water system, through which contaminants are likely to move toward and reach the well or well field.

**History:** 1989 c 326 art 3 s 2; 1990 c 597 s 16-20; 1991 c 355 s 6-8; 1999 c 153 s 1-3; 2000 c 260 s 15; 2005 c 106 s 9-15; 2006 c 281 art 3 s 16; 2008 c 277 art 1 s 5

## **JURISDICTION OVER WELLS AND BORINGS**

### **103I.101 POWERS AND DUTIES OF COMMISSIONER OF HEALTH.**

Subdivision 1. **Powers of commissioner.** The commissioner has the powers reasonable and necessary to effectively exercise the authority granted by this chapter.

Subd. 2. **Duties.** The commissioner shall:

- (1) regulate the drilling, construction, modification, repair, and sealing of wells and borings;
- (2) examine and license well contractors; persons constructing, repairing, and sealing vertical heat exchangers; persons modifying or repairing well casings, well screens, or well diameters; persons constructing, repairing, and sealing drive point wells or dug wells; persons constructing, repairing, and sealing dewatering wells; persons sealing wells; persons installing well pumps or pumping equipment; and persons excavating or drilling holes for the installation of elevator borings or hydraulic cylinders;
- (3) register and examine monitoring well contractors;
- (4) license explorers engaged in exploratory boring and examine individuals who supervise or oversee exploratory boring;
- (5) after consultation with the commissioner of natural resources and the Pollution Control Agency, establish standards for the design, location, construction, repair, and sealing of wells and borings within the state; and
- (6) issue permits for wells, groundwater thermal devices, vertical heat exchangers, and elevator borings.

Subd. 3. **Procedures for permits.** The commissioner shall establish procedures for application, approval, and issuance of permits by rule.

Subd. 4. **Inspections by commissioner.** The commissioner may inspect, collect water samples, and have access, at all reasonable times, to a well or boring site, including wells or borings drilled, sealed, or repaired.

Subd. 5. **Commissioner to adopt rules.** The commissioner shall adopt rules including:

- (1) issuance of licenses for:
  - (i) qualified well contractors, persons modifying or repairing well casings, well screens, or well diameters;
  - (ii) persons constructing, repairing, and sealing drive point wells or dug wells;
  - (iii) persons constructing, repairing, and sealing dewatering wells;
  - (iv) persons sealing wells;
  - (v) persons installing well pumps or pumping equipment;
  - (vi) persons constructing, repairing, and sealing vertical heat exchangers; and
  - (vii) persons constructing, repairing, and sealing elevator borings;
- (2) issuance of registration for monitoring well contractors;
- (3) establishment of conditions for examination and review of applications for license and registration;
- (4) establishment of conditions for revocation and suspension of license and registration;
- (5) establishment of minimum standards for design, location, construction, repair, and sealing of wells and borings to implement the purpose and intent of this chapter;
- (6) establishment of a system for reporting on wells and borings drilled and sealed;
- (7) establishment of standards for the construction, maintenance, sealing, and water quality monitoring of wells in areas of known or suspected contamination;
- (8) establishment of wellhead protection measures for wells serving public water supplies;
- (9) establishment of procedures to coordinate collection of well and boring data with other state and local governmental agencies;
- (10) establishment of criteria and procedures for submission of well and boring logs, formation samples or well or boring cuttings, water samples, or other special information required for and water resource mapping; and
- (11) establishment of minimum standards for design, location, construction, maintenance, repair, sealing, safety, and resource conservation related to borings, including exploratory borings as defined in section 103I.005, subdivision 9.



Subd. 6. **Fees for variances.** The commissioner shall charge a nonrefundable application fee of \$215 to cover the administrative cost of processing a request for a variance or modification of rules adopted by the commissioner under this chapter.

**History:** 1989 c 326 art 3 s 3; 1990 c 597 s 21-23; 1991 c 355 s 9-12; 1994 c 557 s 19; 1996 c 305 art 2 s 21; 1997 c 203 art 2 s 4; 1999 c 153 s 4,5; 1Sp2001 c 9 art 1 s 3; 2002 c 379 art 1 s 113; 2005 c 106 s 16, 17; 1Sp2005 c 4 art 6 s 2; 2007 c 147 art 16 s 2

### **103I.103 WASTE PREVENTION MAY BE REQUIRED.**

The commissioner of natural resources may require the owners of wells, especially flowing artesian wells, to prevent waste to conserve the groundwater water supply of the state.

**History:** 1989 c 326 art 3 s 4

### **103I.105 ADVISORY COUNCIL ON WELLS AND BORINGS.**

(a) The Advisory Council on Wells and Borings is established as an advisory council to the commissioner. The advisory council shall consist of 18 voting members. Of the 18 voting members:

- (1) one member must be from the Department of Health, appointed by the commissioner of health;
- (2) one member must be from the Department of Natural Resources, appointed by the commissioner of natural resources;
- (3) one member must be a member of the Minnesota Geological Survey of the University of Minnesota, appointed by the director;
- (4) one member must be a responsible individual for a licensed explorer;
- (5) one member must be a certified representative of a licensed elevator boring contractor;
- (6) two members must be members of the public who are not connected with the boring or well drilling industry;
- (7) one member must be from the Pollution Control Agency, appointed by the commissioner of the Pollution Control Agency;
- (8) one member must be from the Department of Transportation, appointed by the commissioner of transportation;
- (9) one member must be from the Board of Water and Soil Resources appointed by its chair;
- (10) one member must be a certified representative of a monitoring well contractor;
- (11) six members must be residents of this state appointed by the commissioner, who are certified representatives of licensed well contractors, with not more than two from the seven-county metropolitan area and at least four from other areas of the state who represent different geographical regions; and
- (12) one member must be a certified representative of a licensed vertical heat exchanger contractor.

(b) An appointee of the well drilling industry may not serve more than two consecutive terms.

(c) The appointees to the advisory council from the well drilling industry must:

- (1) have been residents of this state for at least three years before appointment; and
- (2) have at least five years' experience in the well drilling business.

(d) The terms of the appointed members and the compensation and removal of all members are governed by section 15.059, except section 15.059, subdivision 5, relating to expiration of the advisory council does not apply.

**History:** 1989 c 326 art 3 s 5; 1991 c 355 s 13; 1999 c 153 s 6; 2005 c 106 s 18

### **103I.111 LOCAL AUTHORITY OVER WELLS AND BORINGS.**

Subdivision 1. **Delegation of duties of commissioner.** (a) The commissioner of health may enter into an agreement with a board of health to delegate all or part of the inspection, reporting, and enforcement duties authorized under provisions of this chapter pertaining to permitting, construction, repair, and sealing of wells and elevator borings.

(b) A board of health may delegate its powers and duties to other boards of health within its jurisdiction. An agreement to delegate powers and duties of a board of health must be approved by the commissioner and is subject to subdivision 3.

Subd. 2. **Delegation agreements.** (a) Agreements authorized under this section must be in writing and signed by the delegating authority and the designated agent.

- (b) The agreement must list criteria the delegating authority will use to determine if the designated agent's performance meets appropriate standards and is sufficient to replace performance by the delegating authority.
- (c) The agreement may specify minimum staff requirements and qualifications, set procedures for the assessment of costs, and provide for termination procedures if the delegating authority finds that the designated agent fails to comply with the agreement.
- (d) A designated agent must not perform licensing, inspection, or enforcement duties under the agreement in territory outside its jurisdiction unless approved by the governing body for that territory through a separate agreement.
- (e) The scope of agreements established under this section is limited to duties and responsibilities agreed upon by the parties. The agreement may provide for automatic renewal and for notice of intent to terminate by either party.
- (f) During the life of the agreement, the delegating authority shall not perform duties that the designated agent is required to perform under the agreement, except inspections necessary to determine compliance with the agreement and this section or as agreed to by the parties.
- (g) The delegating authority shall consult with, advise, and assist a designated agent in the performance of its duties under the agreement.
- (h) This section does not alter the responsibility of the delegating authority for the performance of duties specified in law.

Subd. 2a. **Fees.** A board of health under a delegation agreement with the commissioner may charge permit and notification fees, including a fee for well sealing, in excess of the fees specified in section 103I.208 if the fees do not exceed the total direct and indirect costs to administer the delegated duties.

Subd. 2b. **Ordinance authority.** A political subdivision may adopt ordinances to enforce and administer powers and duties delegated under this section. The ordinances may not be inconsistent with or be less restrictive than standards in state law or rule. Ordinances adopted by the governing body of a statutory or home rule charter city or town may not be inconsistent with or be less restrictive than ordinances adopted by the county board. The commissioner shall review ordinances proposed under a delegation agreement. The commissioner shall approve ordinances if the commissioner determines the ordinances are not inconsistent with and not less restrictive than the provisions of this chapter.

Subd. 2c. **Permits.** A board of health under a delegation agreement with the commissioner may require permits in lieu of the notifications required under sections 103I.205 and 103I.301.

Subd. 3. **Preemption unless delegation.** Notwithstanding any other law, a political subdivision may not regulate the construction, repair, or sealing of wells or borings unless the commissioner delegates authority under subdivisions 1 and 2.

Subd. 4. **Local authority over exploratory boring.** This chapter does not limit the authority of a local unit of government to prohibit mineral exploration within its boundaries, require permits from explorers, or impose reasonable requirements and fees upon explorers, that are consistent with other law.

Subd. 5. **Local government regulation of open wells and recharging basins.** (a) The governing body of a county, municipality, statutory or home rule charter city, or town may regulate open wells and recharging basins in a manner not inconsistent with this chapter and rules and may provide penalties for the violations. The use or maintenance of an open well or recharging basin that endangers the safety of a considerable number of persons may be defined as a public nuisance and abated as a public nuisance. (b) The abatement of the public nuisance may include covering the open well or recharging basin or surrounding the open well or recharging basin with a protective fence.

Subd. 6. **Unsealed wells are public health nuisances.** A well that is required to be sealed under section 103I.301 but is not sealed is a public health nuisance. A county may abate the unsealed well with the same authority of a board of health to abate a public health nuisance under section 145A.04, subdivision 8.

Subd. 7. **Local license or registration fees prohibited.** (a) A political subdivision may not require a licensed well contractor to pay a license or registration fee.

(b) The commissioner of health must provide a political subdivision with a list of licensed well contractors upon request.

Subd. 8. **Municipal regulation of drilling.** A municipality may regulate all drilling, except well, elevator shaft, and exploratory drilling that is subject to the provisions of this chapter, above, in, through, and adjacent to subsurface areas designated for mined underground space development and existing mined underground space. The regulations may prohibit, restrict, control, and require permits for the drilling.

**History:** 1989 c 326 art 3 s 6; 1990 c 597 s 24-26; 1991 c 355 s 14-17; 2005 c 106 s 19,20

**103I.112** [Repealed, 2009 c 79 art 10 s 51]

### **103I.113 APPLICABILITY TO MINING ACTIVITIES.**

The provisions of this chapter do not apply to mining activities within a mining area described in a permit to mine issued under section 93.481 except a well or boring from which water is withdrawn. The provisions of this chapter do not apply to borings made within an area for which a conditional use permit for kaolin clay extraction has been obtained from the appropriate permitting authority when the kaolin clay extraction activity will remove all of the materials in which the borings occurred except a well or boring from which water is withdrawn.

**History:** 1989 c 326 art 3 s 7; 1993 c 113 art 3 s 1

## **WELL CONSTRUCTION AND OWNERSHIP**

### **103I.115 COMPLIANCE WITH THIS CHAPTER REQUIRED.**

A person may not construct, repair, or seal a well or boring, except as provided under the provisions of this chapter.

**History:** 1989 c 326 art 3 s 8; 1992 c 544 s 5; 2005 c 106 s 21

### **103I.205 WELL CONSTRUCTION.**

Subdivision 1. **Notification required.** (a) Except as provided in paragraphs (d) and (e), a person may not construct a well until a notification of the proposed well on a form prescribed by the commissioner is filed with the commissioner with the filing fee in section 103I.208. If after filing the well notification an attempt to construct a well is unsuccessful, a new notification is not required unless the information relating to the successful well has substantially changed.

(b) The property owner, the property owner's agent, or the well contractor where a well is to be located must file the well notification with the commissioner.

(c) The well notification under this subdivision preempts local permits and notifications, and counties or home rule charter or statutory cities may not require a permit or notification for wells unless the commissioner has delegated the permitting or notification authority under section 103I.111.

(d) A person who is an individual that constructs a drive point well on property owned or leased by the individual for farming or agricultural purposes or as the individual's place of abode must notify the commissioner of the installation and location of the well. The person must complete the notification form prescribed by the commissioner and mail it to the commissioner by ten days after the well is completed. A fee may not be charged for the notification. A person who sells drive point wells at retail must provide buyers with notification forms and informational materials including requirements regarding wells, their location, construction, and disclosure. The commissioner must provide the notification forms and informational materials to the sellers.

(e) A person may not construct a monitoring well until a permit is issued by the commissioner for the construction. If after obtaining a permit an attempt to construct a well is unsuccessful, a new permit is not required as long as the initial permit is modified to indicate the location of the successful well.

**Subd. 2. Emergency permit and notification exemptions.** The commissioner may adopt rules that modify the procedures for filing a well notification or well permit if conditions occur that:

- (1) endanger the public health and welfare or cause a need to protect the groundwater; or
- (2) require the monitoring well contractor, limited well/boring contractor, or well contractor to begin constructing a well before obtaining a permit or notification.

**Subd. 3. Maintenance permit.** (a) Except as provided under paragraph (b), a well that is not in use must be sealed or have a maintenance permit.

(b) If a monitoring well or a dewatering well is not sealed by 14 months after completion of construction, the owner of the property on which the well is located must obtain and annually renew a maintenance permit from the commissioner.

**Subd. 4. License required.** (a) Except as provided in paragraph (b), (c), (d), or (e), section 103I.401, subdivision 2, or section 103I.601, subdivision 2, a person may not drill, construct, repair, or seal a well or boring unless the person has a well contractor's license in possession.

(b) A person may construct, repair, and seal a monitoring well if the person:

- (1) is a professional engineer licensed under sections 326.02 to 326.15 in the branches of civil or geological engineering;
- (2) is a hydrologist or hydrogeologist certified by the American Institute of Hydrology;
- (3) is a professional geoscientist licensed under sections 326.02 to 326.15;
- (4) is a geologist certified by the American Institute of Professional Geologists; or
- (5) meets the qualifications established by the commissioner in rule.

A person must register with the commissioner as a monitoring well contractor on forms provided by the commissioner.

(c) A person may do the following work with a limited well/boring contractor's license in possession. A separate license is required for each of the six activities:

- (1) installing or repairing well screens or pitless units or pitless adaptors and well casings from the pitless adaptor or pitless unit to the upper termination of the well casing;
- (2) constructing, repairing, and sealing drive point wells or dug wells;
- (3) installing well pumps or pumping equipment;
- (4) sealing wells;
- (5) constructing, repairing, or sealing dewatering wells; or
- (6) constructing, repairing, or sealing vertical heat exchangers.

(d) A person may construct, repair, and seal an elevator boring with an elevator boring contractor's license.

(e) Notwithstanding other provisions of this chapter requiring a license or registration, a license or registration is not required for a person who complies with the other provisions of this chapter if the person is:

- (1) an individual who constructs a well on land that is owned or leased by the individual and is used by the individual for farming or agricultural purposes or as the individual's place of abode; or
- (2) an individual who performs labor or services for a contractor licensed or registered under the provisions of this chapter in connection with the construction, sealing, or repair of a well or boring at the direction and under the personal supervision of a contractor licensed or registered under the provisions of this chapter.

**Subd. 5. At-grade monitoring wells.** At-grade monitoring wells are authorized without variance and may be installed for the purpose of evaluating groundwater conditions or for use as a leak detection device. An at-grade monitoring well must be installed in accordance with the rules of the commissioner. The at-grade monitoring wells must be installed with an impermeable double locking cap approved by the commissioner and must be labeled monitoring wells.

**Subd. 6. Distance requirements for sources of contamination.** (a) A person may not place, construct, or install an actual or potential source of contamination any closer to a well than the isolation distances prescribed by the commissioner by rule unless a variance has been prescribed by rule.

(b) The commissioner shall establish by rule reduced isolation distances for facilities which have safeguards in accordance with sections 18B.01, subdivision 26, and 18C.005, subdivision 29.

Subd. 7. **Well identification label required.** After a well has been constructed, the person constructing the well must attach a label to the well showing the unique well number.

Subd. 8. **Wells on property of another.** A person may not construct or have constructed a well for the person's own use on the property of another until the owner of the property on which the well is to be located and the intended well user sign a written agreement that identifies which party will be responsible for obtaining all permits or filing notification, paying applicable fees and for sealing the well. If the property owner refuses to sign the agreement, the intended well user may, in lieu of a written agreement, state in writing to the commissioner that the well user will be responsible for obtaining permits, filing notification, paying applicable fees, and sealing the well. Nothing in this subdivision eliminates the responsibilities of the property owner under this chapter, or allows a person to construct a well on the property of another without consent or other legal authority.

Subd. 9. **Report of work.** Within 30 days after completion or sealing of a well or boring, the person doing the work must submit a verified report to the commissioner containing the information specified by rules adopted under this chapter. Within 30 days after receiving the report, the commissioner shall send or otherwise provide access to a copy of the report to the commissioner of natural resources, to the local soil and water conservation district where the well is located, and to the director of the Minnesota Geological Survey.

**History:** 1989 c 326 art 3 s 9; 1990 c 597 s 28-33; 1991 c 355 s 18-23; 1992 c 507 s 22; 1994 c 557 s 20; 1999 c 153 s 7,8; 2005 c 106 s 22,23

### **103I.208 NOTIFICATION FILING FEES AND PERMIT FEES.**

Subdivision 1. **Well notification fee.** The well notification fee to be paid by a property owner is:

- (1) for a new water-supply well, \$215, which includes the state core function fee;
- (2) for a well sealing, \$50 for each well, which includes the state core function fee, except that for monitoring wells constructed on a single property, having depths within a 25 foot range, and sealed within 48 hours of start of construction, a single fee of \$50; and
- (3) for construction of a dewatering well, \$215, which includes the state core function fee, for each dewatering well except a dewatering project comprising five or more dewatering wells shall be assessed a single fee of \$1,075 for the dewatering wells recorded on the notification.

Subd. 1a. **State core function fee.** The state core function fee to be collected by the state and delegated boards of health and used to support state core functions is:

- (1) for a new well, \$20; and
- (2) for a well sealing, \$5.

Subd. 2. **Permit fee.** The permit fee to be paid by a property owner is:

- (1) for a water-supply well that is not in use under a maintenance permit, \$175 annually;
- (2) for construction of a monitoring well, \$215, which includes the state core function fee;
- (3) for a monitoring well that is unsealed under a maintenance permit, \$175 annually;
- (4) for a monitoring well owned by a federal agency, state agency, or local unit of government that is unsealed under a maintenance permit, \$50 annually. "Local unit of government" means a statutory or home rule charter city, town, county, or soil and water conservation district, watershed district, an organization formed for the joint exercise of powers under section 471.59, a board of health or community health board, or other special purpose district or authority with local jurisdiction in water and related land resources management;
- (5) for monitoring wells used as a leak detection device at a single motor fuel retail outlet, a single petroleum bulk storage site excluding tank farms, or a single agricultural chemical facility site, the construction permit fee is \$215, which includes the state core function fee, per site regardless of the number of wells constructed on the site, and the annual fee for a maintenance permit for unsealed monitoring wells is \$175 per site regardless of the number of monitoring wells located on site;
- (6) for a groundwater thermal exchange device, in addition to the notification fee for water-supply

wells, \$215, which includes the state core function fee;

(7) for a vertical heat exchanger with less than ten tons of heating/cooling capacity, \$215;

(8) for a vertical heat exchanger with ten to 50 tons of heating/cooling capacity, \$425;

(9) for a vertical heat exchanger with greater than 50 tons of heating/cooling capacity, \$650;

(10) for a dewatering well that is unsealed under a maintenance permit, \$175 annually for each dewatering well, except a dewatering project comprising more than five dewatering wells shall be issued a single permit for \$875 annually for dewatering wells recorded on the permit; and

(11) for an elevator boring, \$215 for each boring.

**History:** 1989 c 326 art 3 s 10; 1990 c 597 s 34; 1991 c 355 s 24; 1994 c 557 s 21; 1997 c 203 art 2 s 5; 1998 c 407 art 2 s 23; 1999 c 247 s 1; 1Sp2001 c 9 art 1 s 5,6; 2002 c 379 art 1 s 113; 2005 c 106 s 24,25; 1Sp2005 c 4 art 6 s 3,4; 2007 c 147 art 16 s 3,4; 209 c 79 art 10 s 1

**103I.211** [Repealed, 1990 c 597 s 73]

### **103I.221 PLASTIC CASINGS.**

Subdivision 1. **Plastic casings allowed.** The use of plastic casings in wells is expressly authorized.

Subd. 2. **Rules.** The commissioner may adopt rules relating to the installation of plastic well casing.

**History:** 1989 c 326 art 3 s 12

**103I.222** [Repealed, 2005 c 106 s 68]

### **103I.231 COMMISSIONER MAY ORDER REPAIRS.**

(a) The commissioner may order a property owner to take remedial measures, including making repairs, reconstructing, or sealing a well or boring according to provisions of this chapter. The order may be issued if the commissioner determines, based on inspection of the water or the well or boring site or an analysis of water from the well or boring, that the well or boring:

(1) is contaminated or may contribute to the spread of contamination;

(2) is required to be sealed under this chapter and has not been sealed according to provisions of this chapter;

(3) is in a state of disrepair so that its continued existence endangers the quality of the groundwater;

(4) is a health or safety hazard; or

(5) is located in a place or constructed in a manner that its continued use or existence endangers the quality of the groundwater.

(b) The order of the commissioner may be enforced in an action to seek compliance brought by the commissioner in the district court of the county where the well or boring is located.

**History:** 1989 c 326 art 3 s 13; 1991 c 355 s 25; 2005 c 106 s 26

### **103I.235 REAL PROPERTY SALE; DISCLOSURE OF LOCATION OF WELLS.**

Subdivision 1. **Disclosure of wells to buyer.** (a) Before signing an agreement to sell or transfer real property, the seller must disclose in writing to the buyer information about the status and location of all known wells on the property, by delivering to the buyer either a statement by the seller that the seller does not know of any wells on the property, or a disclosure statement indicating the legal description and county, and a map drawn from available information showing the location of each well to the extent practicable. In the disclosure statement, the seller must indicate, for each well, whether the well is in use, not in use, or sealed.

(b) At the time of closing of the sale, the disclosure statement information, name and mailing address of the buyer, and the quartile, section, township, and range in which each well is located must be provided on a well disclosure certificate signed by the seller or a person authorized to act on behalf of the seller.

(c) A well disclosure certificate need not be provided if the seller does not know of any wells on the property and the deed or other instrument of conveyance contains the statement: "The Seller certifies that the Seller does not know of any wells on the described real property."

(d) If a deed is given pursuant to a contract for deed, the well disclosure certificate required by this subdivision shall be signed by the buyer or a person authorized to act on behalf of the buyer. If the buyer knows of no wells on the property, a well disclosure certificate is not required if the following statement appears on the deed followed by the signature of the grantee or, if there is more than one grantee, the signature of at least one of the grantees: "The Grantee certifies that the Grantee does not know of any wells on the described real property." The statement and signature of the grantee may be on the front or back of the deed or on an attached sheet and an acknowledgment of the statement by the grantee is not required for the deed to be recordable.

(e) This subdivision does not apply to the sale, exchange, or transfer of real property:

(1) that consists solely of a sale or transfer of severed mineral interests; or

(2) that consists of an individual condominium unit as described in chapters 515 and 515B.

(f) For an area owned in common under chapter 515 or 515B the association or other responsible person must report to the commissioner by July 1, 1992, the location and status of all wells in the common area. The association or other responsible person must notify the commissioner within 30 days of any change in the reported status of wells.

(g) If the seller fails to provide a required well disclosure certificate, the buyer, or a person authorized to act on behalf of the buyer, may sign a well disclosure certificate based on the information provided on the disclosure statement required by this section or based on other available information.

(h) A county recorder or registrar of titles may not record a deed or other instrument of conveyance dated after October 31, 1990, for which a certificate of value is required under section 272.115, or any deed or other instrument of conveyance dated after October 31, 1990, from a governmental body exempt from the payment of state deed tax, unless the deed or other instrument of conveyance contains the statement made in accordance with paragraph (c) or (d) or is accompanied by the well disclosure certificate containing all the information required by paragraph (b) or (d). The county recorder or registrar of titles must not accept a certificate unless it contains all the required information. The county recorder or registrar of titles shall note on each deed or other instrument of conveyance accompanied by a well disclosure certificate that the well disclosure certificate was received. The notation must include the statement "No wells on property" if the disclosure certificate states there are no wells on the property. The well disclosure certificate shall not be filed or recorded in the records maintained by the county recorder or registrar of titles. After noting "No wells on property" on the deed or other instrument of conveyance, the county recorder or registrar of titles shall destroy or return to the buyer the well disclosure certificate. The county recorder or registrar of titles shall collect from the buyer or the person seeking to record a deed or other instrument of conveyance, a fee of \$45 for receipt of a completed well disclosure certificate. By the tenth day of each month, the county recorder or registrar of titles shall transmit the well disclosure certificates to the commissioner of health. By the tenth day after the end of each calendar quarter, the county recorder or registrar of titles shall transmit to the commissioner of health \$37.50 of the fee for each well disclosure certificate received during the quarter. The commissioner shall maintain the well disclosure certificate for at least six years. The commissioner may store the certificate as an electronic image. A copy of that image shall be as valid as the original.

(i) No new well disclosure certificate is required under this subdivision if the buyer or seller, or a person authorized to act on behalf of the buyer or seller, certifies on the deed or other instrument of conveyance that the status and number of wells on the property have not changed since the last previously filed well disclosure certificate. The following statement, if followed by the signature of the person making the statement, is sufficient to comply with the certification requirement of this paragraph: "I am familiar with the property described in this instrument and I certify that the status and number of wells on the described real property have not changed since the last previously filed well disclosure certificate." The certification and signature may be on the front or back of the deed or on an attached sheet and an acknowledgment of the statement is not required for the deed or other instrument of conveyance to be recordable.

(j) The commissioner in consultation with county recorders shall prescribe the form for a well disclosure certificate and provide well disclosure certificate forms to county recorders and registrars of titles and other interested persons.

(k) Failure to comply with a requirement of this subdivision does not impair:

(1) the validity of a deed or other instrument of conveyance as between the parties to the deed or instrument or as to any other person who otherwise would be bound by the deed or instrument; or

(2) the record, as notice, of any deed or other instrument of conveyance accepted for filing or recording contrary to the provisions of this subdivision.

Subd. 2. **Liability for failure to disclose.** Unless the buyer and seller agree to the contrary, in writing, before the closing of the sale, a seller who fails to disclose the existence or known status of a well at the time of sale and knew or had reason to know of the existence or known status of the well, is liable to the buyer for costs relating to sealing of the well and reasonable attorney fees for collection of costs from the seller, if the action is commenced within six years after the date the buyer closed the purchase of the real property where the well is located.

**History:** 1989 c 326 art 3 s 14; 1990 c 597 s 35; 1991 c 292 art 2 s 2; 1991 c 355 s 26; 1992 c 544 s 6; 1994 c 557 s 22; 1997 c 7 art 1 s 23; 1999 c 11 art 3 s 6; 1Sp2001 c 9 art 1 s 7; 2002 c 379 art 1 s 113; 1Sp2005 c 4 art 6 s 5; 2007 c 147 art 16 s 5; 2008 c 277 art 1 s 6

### **103I.236 WELL DISCLOSURE IN WASHINGTON COUNTY.**

Before signing an agreement to sell or transfer real property in Washington County that is not served by a municipal water system, the seller must state in writing to the buyer whether, to the seller's knowledge, the property is located within a special well construction area designated by the commissioner of health under Minnesota Rules, part 4725.3650. If the disclosure under section 103I.235, subdivision 1, paragraph (a), states that there is an unsealed well on the property, the disclosure required under this clause must be made regardless of whether the property is served by a municipal water system.

**History:** 2003 c 128 art 1 s 170

### **103I.241 ACTION FOR WELL CONTAMINATION.**

Subdivision 1. **Owner's cause of action for well contamination.** The owner of real property where a well is located has a cause of action for civil damages against a person whose action or inaction caused contamination of a well. The property owner may commence an action for a period of six years after the owner knows or becomes aware of the contamination of the well.

Subd. 2. **Court awards.** The court may award damages, reasonable attorney fees, and costs and disbursements.

**History:** 1989 c 326 art 3 s 15

## **WELL SEALING**

### **103I.301 WELL SEALING REQUIREMENTS.**

Subdivision 1. **Wells and borings.** (a) A property owner must have a well or boring sealed if:

(1) the well or boring is contaminated or may contribute to the spread of contamination;

(2) the well or boring was attempted to be sealed but was not sealed according to the provisions of this chapter; or

(3) the well or boring is located, constructed, or maintained in a manner that its continued use or existence endangers groundwater quality or is a safety or health hazard.



(b) A well that is not in use must be sealed unless the property owner has a maintenance permit for the well.

(c) The property owner must have a well or boring sealed by a registered or licensed person authorized to seal the well or boring, consistent with provisions of this chapter.

Subd. 2. **Monitoring wells.** The owner of the property where a monitoring well is located must have the monitoring well sealed when the well is no longer in use. The owner must have a well contractor, limited well/boring sealing contractor, or a monitoring well contractor seal the monitoring well.

Subd. 3. **Dewatering wells.** (a) The owner of the property where a dewatering well is located must have the dewatering well sealed when the dewatering well is no longer in use.

(b) A well contractor, limited well/boring sealing contractor, or limited dewatering well contractor shall seal the dewatering well.

Subd. 4. **Sealing procedures.** Wells and borings must be sealed according to rules adopted by the commissioner.

Subd. 5. [Repealed, 1990 c 597 s 73]

Subd. 6. **Notification required.** A person may not seal a well until a notification of the proposed sealing is filed as prescribed by the commissioner.

**History:** 1989 c 326 art 3 s 16; 1990 c 597 s 36; 1991 c 355 s 27,28; 1992 c 544 s 7,8; 1999 c 153 s 9,10

### **103I.311 IDENTIFICATION AND SEALING OF WELLS ON STATE PROPERTY.**

Subdivision 1. **Identification of wells.** The commissioner of natural resources in cooperation with other state agencies must identify the location and status of wells and abandoned wells located on state property.

Subd. 2. **Plan and appropriation request for well sealing.** In each budget year of a biennium, the commissioner must present a plan and an appropriation request to properly seal wells on state property.

Subd. 3. **Prohibition on state land purchased without well identification.** The state may not purchase or sell a fee interest in real property without identifying the location of all wells on the property, whether in use, not in use, or sealed, and making provisions to have the wells not in use properly sealed at the cost of the seller as part of the contract. The deed or other instrument of conveyance evidencing the sale may not be recorded with the county recorder or registrar of titles unless this subdivision is complied with. Failure to comply with a requirement of this subdivision does not impair: (1) the validity of a deed or other instrument of conveyance as between the parties to the deed or instrument or as to any other person who otherwise would be bound by the deed or instrument; or (2) the record, as notice, of any deed or other instrument of conveyance accepted for filing or recording contrary to the provisions of this subdivision.

**History:** 1989 c 326 art 3 s 17; 1990 c 597 s 37; 1991 c 355 s 29, 2008 c 277 art 1s 7

### **103I.315 ORDERS TO SEAL WELLS AND BORINGS.**

Subdivision 1. **Order to seal well or boring.** The commissioner may order a property owner to seal a well or boring if:

- (1) the commissioner determines that without being sealed the well or boring is an imminent threat to public health or public safety;
- (2) the well or boring is required to be sealed under section 103I.301; or
- (3) a well is a monitoring well or dewatering well and by 14 months after construction of the well, the owner has not obtained a maintenance permit, or after a maintenance permit has been issued the owner has not renewed a maintenance permit.

Subd. 2. **Failure of owner to seal well or boring.** If the property owner fails to seal a well or boring in the time provided in the commissioner's order, or if the commissioner is unable to identify or locate the property owner, the commissioner may enter the property and have the well or boring sealed. The property owner is liable for and must pay the costs of sealing the well or boring.

**History:** 1989 c 326 art 3 s 18; 1992 c 544 s 9

**103I.321** [Repealed, 1990 c 597 s 73]

### **103I.325 LANDOWNER SEALED WELL AND BORING LIABILITY.**

Subdivision 1. [Repealed, 1990 c 597 s 73]

Subd. 2. **Liability after sealing.** The owner of a well or boring is not liable for contamination of groundwater from the well or boring that occurs after the well or boring has been sealed by a licensed contractor in compliance with this chapter if a report of sealing has been filed with the commissioner of health by the contractor who performed the work, and if the owner has not disturbed or disrupted the sealed well or boring.

**History:** 1989 c 326 art 3 s 20; 1990 c 597 s 38; 2005 c 106 s 27

**103I.331** [Repealed, 1989 c 326 art 3 s 21, subd 6; 1994 c 557 s 23]

### **103I.335 FUNDING FOR PERSONS TO SEAL WELLS.**

Subdivision 1. **Application.** A property owner who desires to seal a well may apply to the Board of Water and Soil Resources for the board to provide funds and seal the well.

Subd. 2. **Criteria for sealing.** The Board of Water and Soil Resources shall adopt criteria for accepting applications to seal wells for property owners applying under subdivision 1.

Subd. 3. **Collection and enforcement of costs.** If the applications are accepted, the costs of sealing become a governmental services lien as provided in section 103I.341. The Board of Water and Soil Resources must enter a written agreement to collect the costs of sealing the well in a manner provided under section 103I.341, subdivision 3. If the costs are not paid according to the agreement, the Board of Water and Soil Resources may enforce the lien in any manner provided under section 103I.341, subdivisions 2 and 3.

**History:** 1989 c 326 art 3 s 22

### **103I.341 COLLECTION AND ENFORCEMENT OF WELL SEALING COSTS.**

Subdivision 1. **Lien for sealing costs.** The commissioner and the Board of Water and Soil Resources have a governmental services lien under section 514.67 for the costs of sealing a well or boring that the commissioner or board has contracted to be sealed under section 103I.315, subdivision 2 ; or 103I.335. The lien attaches to the real property where the well or boring is located. The lien is perfected by recording the lien with the county recorder or registrar of titles where the well or boring and the property are located and serving or mailing by return receipt a copy of the lien to the property owner.

Subd. 2. **Enforcement of lien.** The commissioner or the Board of Water and Soil Resources may enforce the lien in the manner provided for a judgment lien under chapter 550 or certify the amount to the county auditor, which must be assessed against the property and collected in the same manner as real estate taxes.

Subd. 3. **Assessment of installments.** (a) In lieu of certifying the entire amount to be collected, the commissioner or the Board of Water and Soil Resources may have the amount due assessed in seven or less equal annual installments plus interest due at the rate determined by the state court administrator for judgments under section 549.09.

(b) The interest due is an additional perfected lien on the property without further action by the commissioner or the Board of Water and Soil Resources.

(c) The interest and the installment due must be entered on the tax lists for the year and collected in the same manner as real estate taxes for that year by collecting one-half of the total of the installment and interest with and as part of the real estate taxes.

Subd. 4. **Satisfaction of lien.** The amount due and interest of a lien under this section may be paid at any time. When the amount of the lien including accrued interest is paid, the commissioner or board must execute a satisfaction of the lien and record the satisfaction with the county recorder or registrar of titles where the lien was recorded.

Subd. 5. **Appropriation of recovered costs.** Costs of sealing wells recovered from property owners by the Board of Water and Soil Resources must be deposited in the state treasury and credited to the account from which the amounts were originally appropriated. The amounts are continuously appropriated to the board for sealing wells.

**History:** 1989 c 326 art 3 s 23; 1992 c 544 s 10,11; 1997 c 7 art 1 s 24; 2005 c 4 s 27,28

### **103I.345 WELL AND BORING SEALING ACCOUNT.**

Subdivision 1. **Revenue sources.** Revenue from the following sources must be deposited in the state treasury and credited to a special account:

- (1) all money recovered by the commissioner under section 103I.341;
- (2) all money paid under section 144.99 or under any agreement, stipulation, or settlement resolving an enforcement action brought by the commissioner;
- (3) all interest attributable to investment of money credited to the account; and
- (4) all money received in the form of gifts, grants, reimbursements, or appropriations from any source intended to be used for the purposes of the account.

Subd. 2. **Expenditures.** Subject to appropriation by law, money in the account established under subdivision 1 may be used by the commissioner for sealing wells and borings.

**History:** 1992 c 544 s 12; 1993 c 206 s 1; 2005 c 106 s 28

## **ELEVATOR BORINGS**

### **103I.401 ELEVATOR BORINGS.**

Subdivision 1. **Permit required.** (a) A person may not construct an elevator boring until a permit for the hole or excavation is issued by the commissioner.

(b) The elevator boring permit preempts local permits except local building permits, and counties and home rule charter or statutory cities may not require a permit for elevator borings.

Subd. 2. **License required.** A person may not construct an elevator boring unless the person possesses a well contractor's license or an elevator boring contractor's license issued by the commissioner.

Subd. 3. **Sealing.** A well contractor or elevator boring contractor must seal a hole or excavation that is no longer used for an elevator boring. The sealing must be done according to rules adopted by the commissioner.

Subd. 4. **Report.** Within 30 days after completion or sealing of an elevator boring, the person doing the work must submit a report to the commissioner on forms provided by the commissioner.

**History:** 1989 c 326 art 3 s 24; 1994 c 557 s 24; 1997 c 203 art 2 s 6; 2005 c 106 s 29

## **ENVIRONMENTAL BORE HOLES**

### **103I.451 ENVIRONMENTAL BORE HOLES.**

An environmental bore hole must be constructed, sealed, and reported as prescribed by rule of the commissioner by a well contractor or a monitoring well contractor.

**History:** 1989 c 326 art 3 s 25

## **LICENSING AND REGISTRATION**

### **103I.501 LICENSING AND REGULATION OF WELLS AND BORINGS.**

(a) The commissioner shall regulate and license:

- (1) drilling, constructing, and repair of wells;
- (2) sealing of wells;
- (3) installing of well pumps and pumping equipment;
- (4) excavating, drilling, repairing, and sealing of elevator borings;
- (5) construction, repair, and sealing of environmental bore holes; and
- (6) construction, repair, and sealing of vertical heat exchangers.

(b) The commissioner shall examine and license well contractors, limited well/boring contractors, and elevator boring contractors, and examine and register monitoring well contractors.

(c) The commissioner shall license explorers engaged in exploratory boring and shall examine persons who supervise or oversee exploratory boring.

**History:** 1989 c 326 art 3 s 26; 1999 c 153 s 11; 2005 c 106 s 30

### **103I.505 RECIPROCITY OF LICENSES AND REGISTRATIONS.**

Subdivision 1. **Reciprocity authorized.** The commissioner may issue a license or register a person under this chapter, without giving an examination, if the person is licensed or registered in another state and:

(1) the requirements for licensing or registration under which the well or boring contractor was licensed or registered do not conflict with this chapter;

(2) the requirements are of a standard not lower than that specified by the rules adopted under this chapter; and

(3) equal reciprocal privileges are granted to licensees or registrants of this state.

Subd. 2. **Fees required.** A well or boring contractor must apply for the license or registration and pay the fees under the provisions of this chapter to receive a license or registration under this section.

**History:** 1989 c 326 art 3 s 27; 2005 c 106 s 31

### **103I.515 LICENSES NOT TRANSFERABLE.**

A license or registration issued under this chapter is not transferable.

**History:** 1989 c 326 art 3 s 28

### **103I.521 FEES DEPOSITED WITH COMMISSIONER OF MANAGEMENT AND BUDGET.**

Fees collected for licenses or registration under this chapter shall be deposited in the state treasury.

**History:** 1989 c 326 art 3 s 29; 2003 c 112 art 2 s 50; 209 c 101 art 2 s 109

### **103I.525 WELL CONTRACTOR'S LICENSE; REPRESENTATIVE'S CERTIFICATION.**

Subdivision 1. **Certification application.** (a) A person must file an application and application fee with the commissioner to represent a well contractor.

(b) The application must state the applicant's qualifications for certification as a representative, and other information required by the commissioner. The application must be on forms prescribed by the commissioner.

(c) A person may apply as an individual if the person:

(1) is not representing a firm, sole proprietorship, partnership, association, corporation, or other entity including the United States government, any interstate body, the state, and an agency, department, or political subdivision of the state; and

(2) meets the well contractor certification and license requirements under this chapter.

Subd. 2. **Certification application fee.** The application fee for certification as a representative of a well contractor is \$75. The commissioner may not act on an application until the application fee is paid.

Subd. 3. **Examination.** After the commissioner has approved the application, the applicant must take an examination given by the commissioner.

Subd. 3a. **Issuance of certification.** If an applicant meets the experience requirements established by rule and passes the examination as determined by the commissioner, the commissioner shall issue the applicant a certification to represent a well contractor.

Subd. 4. **Issuance of license.** If a person employs a certified representative, submits the bond under subdivision 5, and pays the license fee under subdivision 6, the commissioner shall issue a well contractor's license.

Subd. 5. **Bond.** (a) As a condition of being issued a well contractor's license, the applicant, except a person applying for an individual well contractor's license, must submit a corporate surety bond for \$25,000 approved by the commissioner. The bond must be conditioned to pay the state on performance of work in this state that is not in compliance with this chapter or rules adopted under this chapter. The bond is in lieu of other license bonds required by a political subdivision of the state.

(b) From proceeds of the bond, the commissioner may compensate persons injured or suffering financial loss because of a failure of the applicant to perform work or duties in compliance with this chapter or

rules adopted under this chapter.

Subd. 6. **License fee.** The fee for a well contractor's license is \$250, except the fee for an individual well contractor's license is \$75.

Subd. 7. **Validity.** A well contractor's license is valid until the date prescribed in the license by the commissioner.

Subd. 8. **Renewal.** (a) A licensee must file an application and a renewal application fee to renew the license by the date stated in the license.

(b) The renewal application fee for a well contractor's license is \$250, except the fee for an individual well contractor's license is \$75.

(c) The renewal application must include information that the certified representative of the applicant has met continuing education requirements established by the commissioner by rule.

(d) At the time of the renewal, the commissioner must have on file all properly completed well and boring construction reports, well and boring sealing reports, reports of elevator borings, water sample analysis reports, well and boring permits, and well notifications for work conducted by the licensee since the last license renewal.

Subd. 9. **Incomplete or late renewal.** If a licensee fails to submit all information required for renewal in subdivision 8 or submits the application and information after the required renewal date:

(1) the licensee must include a late fee of \$75; and

(2) the licensee may not conduct activities authorized by the well contractor's license until the renewal application, renewal application fee, late fee, and all other information required in subdivision 8 are submitted.

**History:** 1989 c 326 art 3 s 30; 1990 c 597 s 40-42; 1991 c 355 s 31-34; 1996 c 305 art 3 s 12,13; 1999 c 250 art 3 s 10; 1Sp2001 c 9 art 1 s 8-11; 2002 c 379 art 1 s 113; 2005 c 106 s 32-37; 2007 c 124 s 1

### **103I.531 LIMITED WELL/BORING CONTRACTOR'S LICENSE; REPRESENTATIVE'S CERTIFICATION.**

Subdivision 1. **Certification application.** (a) A person must file an application and an application fee with the commissioner to represent a limited well/boring contractor.

(b) The application must state the applicant's qualifications for the certification, and other information required by the commissioner. The application must be on forms prescribed by the commissioner.

Subd. 2. **Certification application fee.** The application fee for certification as a representative of a limited well/boring contractor is \$75. The commissioner may not act on an application until the application fee is paid.

Subd. 3. **Examination.** After the commissioner has approved the application, the applicant must take an examination given by the commissioner.

Subd. 3a. **Issuance of certification.** If an applicant meets the experience requirements established by rule and passes the examination as determined by the commissioner, the commissioner shall issue the applicant a certification to represent a limited well/boring contractor.

Subd. 4. **Issuance of license.** If a person employs a certified representative, submits the bond under subdivision 5, and pays the license fee under subdivision 6, the commissioner shall issue a limited well/boring contractor's license. If the other conditions of this section are satisfied, the commissioner may not withhold issuance of a dewatering limited license based on the applicant's lack of prior experience under a licensed well contractor.

Subd. 5. **Bond.** (a) As a condition of being issued a limited well/boring contractor's license for constructing, repairing, and sealing drive point wells or dug wells, sealing wells or borings, constructing, repairing, and sealing dewatering wells, or constructing, repairing, and sealing vertical heat exchangers, the applicant must submit a corporate surety bond for \$10,000 approved by the commissioner. As a condition of being issued a limited well/boring contractor's license for installing or repairing well screens or pitless units or pitless adaptors and well casings from the pitless adaptor or pitless unit to the upper termination of the well casing, or installing well pumps or pumping equipment, the applicant must submit a corporate surety bond for \$2,000 approved by the commissioner. The bonds required in this paragraph

must be conditioned to pay the state on performance of work in this state that is not in compliance with this chapter or rules adopted under this chapter. The bonds are in lieu of other license bonds required by a political subdivision of the state.

(b) From proceeds of a bond required in paragraph (a), the commissioner may compensate persons injured or suffering financial loss because of a failure of the applicant to perform work or duties in compliance with this chapter or rules adopted under this chapter.

Subd. 6. **License fee.** The fee for a limited well/boring contractor's license is \$75. The fee for three or more limited well/boring contractor licenses is \$225.

Subd. 7. **Validity.** A limited well/boring contractor's license is valid until the date prescribed in the license by the commissioner.

Subd. 8. **Renewal.** (a) A person must file an application and a renewal application fee to renew the limited well/boring contractor's license by the date stated in the license.

(b) The renewal application fee for a limited well/boring contractor's license is \$75.

(c) The renewal application must include information that the certified representative of the applicant has met continuing education requirements established by the commissioner by rule.

(d) At the time of the renewal, the commissioner must have on file all properly completed well and boring construction reports, well and boring sealing reports, well and boring permits, water quality sample reports, and well notifications for work conducted by the licensee since the last license renewal.

Subd. 9. **Incomplete or late renewal.** If a licensee fails to submit all information required for renewal in subdivision 8 or submits the application and information after the required renewal date:

(1) the licensee must include a late fee of \$75; and

(2) the licensee may not conduct activities authorized by the limited well/boring contractor's license until the renewal application, renewal application fee, and late fee, and all other information required in subdivision 8 are submitted.

**History:** 1989 c 326 art 3 s 31; 1990 c 597 s 43; 1991 c 355 s 35-37; 1996 c 305 art 3 s 14,15; 1999 c 153 s 12; 1999 c 250 art 3 s 11; 1Sp2001 c 9 art 1 s 12-15; 2002 c 379 art 1 s 113; 2005 c 106 s 38-43; 2007 c 124 s 2

**103I.533** [Repealed, 1990 c 597 s 73]

### **103I.535 ELEVATOR BORING CONTRACTOR'S LICENSE; REPRESENTATIVE'S CERTIFICATION.**

Subdivision 1. **Certification application.** (a) An individual must file an application and application fee with the commissioner to represent an elevator boring contractor.

(b) The application must state the applicant's qualifications for the certification, and other information required by the commissioner. The application must be on forms prescribed by the commissioner.

Subd. 2. **Certification application fee.** The application fee for certification as a representative of an elevator boring contractor is \$75. The commissioner may not act on an application until the application fee is paid.

Subd. 3. **Examination.** After the commissioner has approved the application, the applicant must take an examination given by the commissioner.

Subd. 3a. **Issuance of certification.** If the applicant meets the experience requirements established by rule and passes the examination as determined by the commissioner, the commissioner shall issue the applicant a certification to represent an elevator boring contractor.

Subd. 4. **Issuance of license.** If a person employs a certified representative, submits the bond under subdivision 5, and pays the license fee under subdivision 6, the commissioner shall issue an elevator boring contractor's license to the applicant.

Subd. 5. **Bond.** (a) As a condition of being issued an elevator boring contractor's license, the applicant must submit a corporate surety bond for \$10,000 approved by the commissioner. The bond must be conditioned to pay the state on performance of work in this state that is not in compliance with this chapter or rules adopted under this chapter.

(b) From proceeds of the bond, the commissioner may compensate persons injured or suffering financial loss because of a failure of the applicant to perform work or duties in compliance with this chapter or rules adopted under this chapter.

Subd. 6. **License fee.** The fee for an elevator shaft contractor's license is \$75.

Subd. 7. **Validity.** An elevator boring contractor's license is valid until the date prescribed in the license by the commissioner.

Subd. 8. **Renewal.** (a) A person must file an application and a renewal application fee to renew the license by the date stated in the license.

(b) The renewal application fee for an elevator boring contractor's license is \$75.

(c) The renewal application must include information that the certified representative of the applicant has met continuing education requirements established by the commissioner by rule.

(d) At the time of renewal, the commissioner must have on file all reports and permits for elevator boring work conducted by the licensee since the last license renewal.

Subd. 9. **Incomplete or late renewal.** If a licensee fails to submit all information required for renewal in subdivision 8 or submits the application and information after the required renewal date:

(1) the licensee must include a late fee of \$75; and

(2) the licensee may not conduct activities authorized by the elevator boring contractor's license until the renewal application, renewal application fee, and late fee, and all other information required in subdivision 8 are submitted.

**History:** 1989 c 326 art 3 s 33; 1991 c 355 s 38,39; 1996 c 305 art 3 s 16; 1997 c 7 art 1 s 25; 1999 c 250 art 3 s 12; 1Sp2001 c 9 art 1 s 16-19; 2002 c 379 art 1 s 113; 2005 c 106 s 44-51

### **103L.541 MONITORING WELL CONTRACTOR'S REGISTRATION; REPRESENTATIVE'S CERTIFICATION.**

Subdivision 1. **Registration.** A person seeking registration as a monitoring well contractor must meet examination and experience requirements adopted by the commissioner by rule.

Subd. 2. **Validity.** A monitoring well contractor's registration is valid until the date prescribed in the registration by the commissioner.

Subd. 2a. **Certification application.** (a) An individual must submit an application and application fee to the commissioner to apply for certification as a representative of a monitoring well contractor.

(b) The application must be on forms prescribed by the commissioner. The application must state the applicant's qualifications for the certification, and other information required by the commissioner.

Subd. 2b. **Issuance of registration.** If a person employs a certified representative, submits the bond under subdivision 3, and pays the registration fee of \$75 for a monitoring well contractor registration, the commissioner shall issue a monitoring well contractor registration to the applicant. The fee for an individual registration is \$75. The commissioner may not act on an application until the application fee is paid.

Subd. 2c. **Certification application fee.** The application fee for certification as a representative of a monitoring well contractor is \$75. The commissioner may not act on an application until the application fee is paid.

Subd. 2d. **Examination.** After the commissioner has approved an application, the applicant must take an examination given by the commissioner.

Subd. 2e. **Issuance of certification.** If the applicant meets the experience requirements established by rule and passes the examination as determined by the commissioner, the commissioner shall issue the applicant a certification to represent a monitoring well contractor.

Subd. 3. **Bond.** (a) As a condition of being issued a monitoring well contractor's registration, the applicant must submit a corporate surety bond for \$10,000 approved by the commissioner. The bond must be conditioned to pay the state on performance of work in this state that is not in compliance with this chapter or rules adopted under this chapter. The bond is in lieu of other license bonds required by a political subdivision of the state.

(b) From proceeds of the bond, the commissioner may compensate persons injured or suffering financial loss because of a failure of the applicant to perform work or duties in compliance with this chapter or rules adopted under this chapter.

Subd. 4. **Renewal.** (a) A person must file an application and a renewal application fee to renew the registration by the date stated in the registration.

(b) The renewal application fee for a monitoring well contractor's registration is \$75.

(c) The renewal application must include information that the certified representative of the applicant has met continuing education requirements established by the commissioner by rule.

(d) At the time of the renewal, the commissioner must have on file all well and boring construction reports, well and boring sealing reports, well permits, and notifications for work conducted by the registered person since the last registration renewal.

Subd. 5. **Incomplete or late renewal.** If a registered person submits a renewal application after the required renewal date:

(1) the registered person must include a late fee of \$75; and

(2) the registered person may not conduct activities authorized by the monitoring well contractor's registration until the renewal application, renewal application fee, late fee, and all other information required in subdivision 4 are submitted.

**History:** 1989 c 326 art 3 s 34; 1990 c 597 s 44-46; 1991 c 355 s 40,41; 1996 c 305 art 3 s 17,18; 1999 c 250 art 3 s 13; 1Sp2001 c 9 art 1 s 20-22; 2002 c 379 art 1 s 113; 2005 c 106 s 52

### **103I.545 REGISTRATION OF DRILLING MACHINES AND HOISTS REQUIRED.**

Subdivision 1. **Drilling machine.** (a) A person may not use a drilling machine such as a cable tool, rotary tool, hollow rod tool, or auger for a drilling activity requiring a license or registration under this chapter unless the drilling machine is registered with the commissioner.

(b) A person must apply for the registration on forms prescribed by the commissioner and submit a \$75 registration fee.

(c) A registration is valid for one year.

Subd. 2. **Hoist.** (a) A person may not use a machine such as a hoist for an activity requiring a license or registration under this chapter to repair wells or borings, seal wells or borings, or install pumps unless the machine is registered with the commissioner.

(b) A person must apply for the registration on forms prescribed by the commissioner and submit a \$75 registration fee.

(c) A registration is valid for one year.

**History:** 1989 c 326 art 3 s 35; 1991 c 355 s 42; 1Sp2001 c 9 art 1 s 23; 2002 c 379 art 1 s 113; 2005 c 106 s 53

## **EXPLORATORY BORINGS**

### **103I.601 EXPLORATORY BORING PROCEDURES.**

Subdivision 1. **Definitions.** (a) For the purposes of this section, the following words have the meanings given them.

(b) "Data" includes samples and factual noninterpreted data obtained from exploratory borings and samples including analytical results.

(c) "Parcel" means a government section, fractional section, or government lot.

(d) "Samples" means at least a one-quarter portion of all samples from exploratory borings that are customarily collected by the explorer. When the exploratory borings are being done to explore or prospect for kaolin clay, "samples" means a representative sample of at least two cubic inches of material per foot from exploratory borings of the material that is customarily collected by the explorer.

Subd. 2. **License required to make borings.** (a) Except as provided in paragraph (d), a person must not make an exploratory boring without an explorer's license. The fee for an explorer's license is \$75. The explorer's license is valid until the date prescribed in the license by the commissioner.

(b) A person must file an application and renewal application fee to renew the explorer's license by the date stated in the license. The renewal application fee is \$75.

(c) If the licensee submits an application fee after the required renewal date, the licensee:

(1) must include a late fee of \$75; and



(2) may not conduct activities authorized by an explorer's license until the renewal application, renewal application fee, late fee, and sealing reports required in subdivision 9 are submitted.

(d) An explorer must designate a responsible individual to supervise and oversee the making of exploratory borings. Before an individual supervises or oversees an exploratory boring, the individual must file an application and application fee of \$75 to qualify as a responsible individual. The individual must take and pass an examination relating to construction, location, and sealing of exploratory borings. A professional engineer or geoscientist licensed under sections 326.02 to 326.15 or a professional geologist certified by the American Institute of Professional Geologists is not required to take the examination required in this subdivision, but must be certified as a responsible individual to supervise an exploratory boring.

**Subd. 3. Notification of project construction.** (a) By 30 days before making an exploratory boring, an explorer must register with the commissioner of natural resources and provide a copy of the registration to the commissioner of health. The registration must include:

(1) the identity of the firm, association, or company engaged in exploratory boring; and

(2) the identification of an agent, including the agent's business address.

(b) The commissioner of natural resources may require a bond, security, or other assurance from an explorer if the commissioner of natural resources has reasonable doubts about the explorer's financial ability to comply with requirements of law relating to exploratory boring. The commissioner's determination to require assurance is exempt from the rulemaking provisions of chapter 14 and section 14.386 does not apply.

(c) An explorer shall annually register with the commissioner of natural resources while conducting exploratory boring.

**Subd. 4. Map of borings.** By ten days before beginning exploratory boring, an explorer must submit to the commissioners of health and natural resources a county road map having a scale of one-half inch equal to one mile, as prepared by the Department of Transportation, or a 7.5 minute series topographic map (1:24,000 scale), as prepared by the United States Geological Survey, showing the location of each proposed exploratory boring to the nearest estimated 40 acre parcel. Exploratory boring that is proposed on the map may not be commenced later than 180 days after submission of the map, unless a new map is submitted.

**Subd. 5. Access to drill sites.** The commissioners of health, natural resources, and the Pollution Control Agency, the community health board as authorized under section 145A.04, and their officers and employees shall have access to exploratory boring sites to inspect the drill holes, drilling, and sealing of the borings, and to sample ambient air and drilling waters, and to measure the radioactivity of the waste drill cuttings at the drilling site at the time of observation.

**Subd. 6. Emergency notification.** The explorer must promptly notify the commissioners of health, natural resources, and the Pollution Control Agency, and the authorized agent of the commissioner of health of an occurrence during exploratory boring that has a potential for significant adverse health or environmental effects. The explorer must take reasonable action to minimize the adverse effects.

**Subd. 7. Inspection of data before submission.** The commissioner of health may, if necessary, inspect data before its submission under section 103L.605. The data examined by the commissioner is not public data before it is submitted under section 103L.605.

**Subd. 8. Permanent and temporary sealing procedures.** Exploratory borings must be temporarily or permanently sealed according to rules adopted by the commissioner.

**Subd. 9. Sealing report.** (a) By 30 days after permanent or temporary sealing of an exploratory boring, the explorer must submit a report to the commissioners of health and natural resources.

(b) The report must be on forms provided by the commissioner of health and include:

(1) the location of each drill hole in as large a scale as possible, which is normally prepared as part of the explorer's record;

(2) the type and thickness of overburden and rock encountered;

(3) identification of water bearing formations encountered;

(4) identification of hydrologic conditions encountered;

(5) method of sealing used;

(6) methods of construction and drilling used; and

(7) average scintillometer reading of waste drill cuttings from uranium or other radioactive mineral exploratory borings before backfilling of the recirculation pits.

**History:** 1989 c 326 art 3 s 36; 1991 c 228 s 2; 1993 c 113 art 3 s 2; 2004 c 221 s 44; 2005 c 106 s 54,55; 1Sp2005 c 4 art 6 s 6

### **103I.605 SUBMISSION OF DATA FROM EXPLORATORY BORINGS.**

Subdivision 1. **Requirement.** Data obtained from exploratory borings must be submitted by the explorer to the commissioner of natural resources as provided in this section.

Subd. 2. **Mineral deposit evaluation data.** (a) In applying for a permit required for activities relating to mineral deposit evaluation, which means examining an area to determine the quality and quantity of minerals, excluding exploratory boring but including obtaining a bulk sample, by excavating, trenching, constructing shafts, ramps, tunnels, pits, and producing refuse and other associated activities, but does not include activities intended, by themselves, for commercial exploitation of the ore body, the explorer must submit to the commissioner of natural resources data relevant to the proposal under consideration. The explorer may identify portions of the data that, if released, would impair the competitive position of the explorer submitting the data. Data identified must be considered to be not public data.

(b) If requested to disclose the data, the commissioner shall mail notice of the request to the explorer and determine whether release of the data would impair the competitive position of the explorer submitting the data. If the commissioner determines that release of the data would impair the competitive position of the explorer submitting the data, the commissioner may not release the data to a person other than parties to the proceedings relating to the permit under consideration. Parties to the proceedings shall maintain the confidentiality of data.

(c) Data that are classified as not public may not be released by the commissioner until 30 days after mailed notice to the explorer of the commissioner's intention to release the data. The commissioner may not release data to a person engaged in exploration, mining, milling, or related industry pertaining to minerals. If the commissioner determines to release data, the explorer may demand a contested case hearing on the commissioner's determination or may withdraw the permit application and the data may not be released.

(d) Any person aggrieved by the decision of the commissioner may appeal the decision according to chapter 14.

Subd. 3. **Mine development data.** In applying for a permit required for mine development, which means activities undertaken after mineral deposit evaluation for commercial exploitation of the ore body, the explorer must submit to the commissioner of natural resources data relevant to the proposal under consideration. The data is public data and persons submitting or releasing the data are not subject to civil or criminal liability for its use by others.

Subd. 4. **Exploration data.** (a) By 180 days after termination by the explorer of a lease or other type of exploration agreement on a property the data from the exploration must be submitted to the commissioner of natural resources. The data are public data and persons submitting or releasing the data are not subject to civil or criminal liability for its use by others.

(b) Data that will become public under paragraph (a) may be submitted, with the prior written permission of the commissioner of natural resources, before the termination. If the data are submitted earlier than the required time, the data do not become public data until 180 days after termination by the explorer of the lease or other type of exploration agreement on the property from which the data are obtained. An explorer submitting data before the time required by paragraph (a) shall provide to the commissioner of natural resources at the time the data are submitted and every 180 days after that time, in a format designated by the commissioner of natural resources, satisfactory evidence that the lease or other type of exploration agreement is in effect. If satisfactory evidence that the mineral lease or other exploration agreement is still in effect is not provided to the commissioner of natural resources for a given 180-day period by the required date, the data immediately become public data. The explorer may waive, in writing, the data privacy requirements and agree that data submitted before the time required by paragraph (a) are public data.

(c) Upon the written request of the explorer, data submitted under paragraph (a) are nonpublic data until 180 days after termination by the explorer of: (1) all other leases or other types of exploration agreements

on property located within the same government section as the property on which the exploratory boring was done, and (2) all other leases or other types of exploration agreements on property located within a government section having at least one point in common along its boundary line with the government section in which the exploratory boring was done; provided that the owner of the property on which the exploration occurred consents to the data not becoming public data. An explorer requesting that the exploration data not become public data shall provide to the commissioner of natural resources at the time the data are submitted and every 180 days after that time, in a format designated by the commissioner of natural resources: (1) satisfactory evidence that the lease or exploration agreement that provides the basis for requesting that the data remain as not public data remains in effect, and (2) satisfactory evidence that the owner of the property upon which the exploration occurred consents to the data not becoming public data. If either of the pieces of satisfactory evidence is not provided to the commissioner of natural resources for a given 180-day period by the required date, the data immediately become public data. The explorer may waive, in writing, the data privacy requirements and agree that the submitted data are public data.

(d) Exploration data and samples submitted under paragraphs (b) and (c) become public data no later than five years after receipt of the exploration data and samples by the commissioner of natural resources even if the lease or other type of exploration agreement described in paragraphs (b) and (c) has not terminated.

**Subd. 5. Designation of samples to be submitted.** The commissioner of natural resources shall designate the samples to be submitted, and specify where the sample is to be delivered. If an explorer requires certain samples in their entirety, the commissioner of natural resources may waive the requirement for a one-fourth portion of the samples. Samples submitted are property of the state.

**History:** 1989 c 326 art 3 s 37; 1991 c 228 s 3; 1993 c 113 art 3 s 3

## GROUNDWATER THERMAL EXCHANGE DEVICES

### 103I.621 PERMITS FOR GROUNDWATER THERMAL EXCHANGE DEVICES.

Subdivision 1. **Permit.** (a) Notwithstanding any department or agency rule to the contrary, the commissioner shall issue, on request by the owner of the property and payment of the permit fee, permits for the reinjection of water by a properly constructed well into the same aquifer from which the water was drawn for the operation of a groundwater thermal exchange device.

(b) As a condition of the permit, an applicant must agree to allow inspection by the commissioner during regular working hours for department inspectors.

(c) Not more than 200 permits may be issued for small systems having maximum capacities of 20 gallons per minute or less. The small systems are subject to inspection twice a year.

(d) Not more than ten permits may be issued for larger systems having maximum capacities from 20 to 50 gallons per minute. The larger systems are subject to inspection four times a year.

(e) A person issued a permit must comply with this section for the permit to be valid.

**Subd. 2. Water use requirements apply.** Water use permit requirements and penalties under chapter 103F and related rules adopted and enforced by the commissioner of natural resources apply to groundwater thermal exchange permit recipients. A person who violates a provision of this section is subject to enforcement or penalties for the noncomplying activity that are available to the commissioner and the Pollution Control Agency.

**Subd. 3. Construction requirements.** (a) Withdrawal and reinjection for the groundwater thermal exchange device must be accomplished by a closed system in which the waters drawn for thermal exchange do not have contact or commingle with water from other sources or with polluting material or substances. The closed system must be constructed to allow an opening for inspection by the commissioner.

(b) Wells that are part of a groundwater thermal exchange system may not serve another function, except water may be supplied to the domestic water system if:

(1) the supply is taken from the thermal exchange system ahead of the heat exchange unit; and

(2) the domestic water system is protected by an airgap or backflow prevention device as described in rules relating to plumbing enforced by the commissioner of labor and industry.

(c) A groundwater thermal exchange system may be used for domestic water heating only if the water heating device is an integral part of the heat exchange unit that is used for space heating and cooling.

Subd. 4. **Rules.** The commissioner may adopt rules to administer this section.

**History:** 1989 c 326 art 3 s 38; 1991 c 355 s 43; 2007 c 140 art 12 s 2

## VERTICAL HEAT EXCHANGERS

### 103I.641 VERTICAL HEAT EXCHANGERS.

Subdivision 1. **Requirements.** A person may not drill or construct an excavation used to install a vertical heat exchanger unless the person is a limited well/boring contractor licensed for constructing, repairing, and sealing vertical heat exchangers or a well contractor.

Subd. 2. **Regulations for vertical heat exchangers.** Vertical heat exchangers must be constructed, maintained, and sealed under the provisions of this chapter.

Subd. 3. **Permit required.** (a) A vertical heat exchanger may not be installed without first obtaining a permit for the vertical heat exchanger from the commissioner. A limited well/boring contractor licensed for constructing, repairing, and sealing vertical heat exchangers or a well contractor must apply for the permit on forms provided by the commissioner and must pay the permit fee.

(b) As a condition of the permit, the owner of the property where the vertical heat exchanger is to be installed must agree to allow inspection by the commissioner during regular working hours of Department of Health inspectors.

**History:** 1989 c 326 art 3 s 39; 1999 c 153 s 13,14

## UNDERGROUND SPACE DEVELOPMENT

### 103I.661 MINED UNDERGROUND SPACE DEVELOPMENT.

Subdivision 1. **Commissioner of natural resources review.** The commissioners of natural resources and health shall review all project plans that involve dewatering of underground formations for construction and operation of mined underground space to determine the effects of the proposal on the quality and quantity of underground waters in and adjacent to the areas where the mined underground space is to be developed.

Subd. 2. **Permit for water removal.** A mined underground space project involving or affecting the quality and quantity of groundwater may not be developed until a water use permit for the appropriation of waters under chapter 103G has been issued by the commissioner of natural resources.

**History:** 1989 c 326 art 3 s 40

## UNDERGROUND STORAGE OF GAS OR LIQUID

### 103I.681 PERMIT FOR UNDERGROUND STORAGE OF GAS OR LIQUID.

Subdivision 1. **Permit required.** (a) The state, a person, partnership, association, private or public corporation, county, municipality, or other political subdivision of the state may not displace groundwater in consolidated or unconsolidated formations by the underground storage of a gas or liquid under pressure without an underground storage permit from the commissioner of natural resources.

(b) The state, a person, a public corporation, county, municipality, or other political subdivision of the state may not store a gas or liquid, except water, below the natural surface of the ground by using naturally occurring rock materials as a storage reservoir without an underground storage permit from the commissioner of natural resources.

Subd. 2. **Application.** (a) A person may apply for an underground storage permit by filing an application form with the commissioner of natural resources accompanied by the application fee and maps, plans, and specifications describing the proposed displacement of groundwater and the underground storage of gases or liquids and other data required by the commissioner.

(b) The commissioner of natural resources shall prescribe the application form to apply for an underground storage permit.

(c) The commissioner of natural resources may require an applicant to demonstrate to the commissioner that the applicant has adequately provided a method to ensure payment of any damages resulting from the operation of a gas or liquid storage reservoir.

Subd. 3. **Hearing required.** (a) An underground storage permit allowing displacement of groundwater may not be issued by the commissioner of natural resources without holding a public hearing on the issuance of the permit.

(b) By 20 days after receiving a complete application, the commissioner of natural resources shall set a time and location for the hearing.

Subd. 4. **Notice of hearing.** The hearing notice must:

(1) state the date, place, and time of the hearing;

(2) show the location of groundwater and surface water and property affected by the proposed underground storage;

(3) be published by the applicant, or by the commissioner of natural resources if the proceeding is initiated by the commissioner of natural resources, once each week for two successive weeks in a legal newspaper that is published in the county where a part or all of the affected groundwater or surface waters are located; and

(4) be mailed by the commissioner of natural resources to the county auditor and the chief executive official of an affected municipality.

Subd. 5. **Procedure at hearing.** (a) The hearing must be public and conducted by the commissioner of natural resources or a referee appointed by the commissioner.

(b) Affected persons must have an opportunity to be heard. Testimony must be taken under oath and the parties must have the right of cross-examination. The commissioner of natural resources shall provide a stenographer, at the expense of the applicant, to take testimony and a record of the testimony, and all proceedings at the hearing shall be taken and preserved.

(c) The commissioner of natural resources is not bound by judicial rules of evidence or of pleading and procedure.

Subd. 6. **Subpoenas.** The commissioner of natural resources may subpoena and compel the attendance of witnesses and the production of books and documents material to the purposes of the hearing.

Disobedience of a subpoena, or refusal to be sworn, or refusal to answer as a witness, is punishable as contempt in the same manner as a contempt of the district court. The commissioner of natural resources must file a complaint of the disobedience with the district court of the county where the disobedience or refusal occurred.

Subd. 7. **Required findings.** An order granting a permit for the proposed storage may not be issued unless it contains and is based on a finding stating:

(1) the proposed storage will be confined to geological stratum or strata lying more than 500 feet below the surface of the soil;

(2) the proposed storage will not substantially impair or pollute groundwater or surface water; and

(3) the public convenience and necessity of a substantial portion of the gas-consuming public in the state will be served by the proposed project.

Subd. 8. **Order conditions.** The order granting the permit must contain conditions and restrictions that will reasonably protect:

(1) private property or an interest not appropriated;

(2) the rights of the property owners and owners of an interest in property located within the boundaries of the proposed storage area, or persons claiming under the owners, to explore for, drill for, produce or develop for the recovery of oil or gas or minerals under the property, and to drill wells on the property to develop and produce water; provided that the exploration, drilling, producing, or developing complies with orders and rules of the commissioner of natural resources that protect underground storage strata or formations against pollution and against the escape of gas; and

(3) public resources of the state that may be adversely affected by the proposed project.

Subd. 9. **Publication of findings, conclusions, orders.** (a) The commissioner of natural resources shall mail notice of any findings, conclusions, and orders made after the hearing to:

- (1) the applicant;
- (2) parties who entered an appearance at the hearing;
- (3) the county auditor; and
- (4) the chief executive officer of an affected municipality.

(b) The commissioner of natural resources must publish notice of findings, conclusions, and orders made after the hearing at least once each week for two successive weeks in a legal newspaper in the county where a part or all of the proposed project is located. The costs of the publication must be paid by the applicant.

Subd. 10. **Appeal of commissioner's determination.** An interested party may appeal the determination of the commissioner of natural resources to the Court of Appeals in accordance with the provisions of chapter 14.

Subd. 11. **Permit fee schedule.** (a) The commissioner of natural resources shall adopt a permit fee schedule under chapter 14. The schedule may provide minimum fees for various classes of permits, and additional fees, which may be imposed subsequent to the application, based on the cost of receiving, processing, analyzing, and issuing the permit, and the actual inspecting and monitoring of the activities authorized by the permit, including costs of consulting services.

(b) A fee may not be imposed on a state or federal governmental agency applying for a permit.

(c) The fee schedule may provide for the refund of a fee, in whole or in part, under circumstances prescribed by the commissioner of natural resources. Fees received must be deposited in the state treasury and credited to the general fund. Permit fees received are appropriated annually from the general fund to the commissioner of natural resources for the costs of inspecting and monitoring the activities authorized by the permit, including costs of consulting services.

**History:** 1989 c 326 art 3 s 41; 1990 c 597 s 47; 1Sp2005 c 1 art 2 s 124

### **103I.685 ABANDONMENT OF UNDERGROUND STORAGE PROJECT.**

An underground storage project for which an underground storage permit is granted may not be abandoned, or a natural or artificial opening extending from the underground storage area to the ground surface be filled, sealed, or otherwise closed to inspection, except after written approval by the commissioner of natural resources and in compliance with conditions that the commissioner may impose.

**History:** 1989 c 326 art 3 s 42; 1990 c 597 s 48

### **103I.691 CERTIFICATE OF USE.**

A person may not use a gas or liquid storage reservoir under an underground storage permit unless the right to use the property affected by the project has been acquired and a notice of the acquisition filed with the commissioner of natural resources. The commissioner of natural resources must issue a certificate approving use of the gas or liquid storage reservoir.

**History:** 1989 c 326 art 3 s 43; 1990 c 597 s 49

## **ENFORCEMENT**

**103I.701** [Repealed, 1993 c 206 s 25]

**103I.705** [Repealed, 1993 c 206 s 25]

### **103I.711 IMPOUNDING OF EQUIPMENT.**

Subdivision 1. **Impoundment.** The commissioner may apply to district court for a warrant authorizing seizure and impoundment of all drilling machines or hoists owned or used by a person. The court shall issue an impoundment order upon the commissioner's showing that a person is constructing, repairing, or sealing wells or borings or installing pumps or pumping equipment or excavating holes for installing

elevator shafts without a license or registration as required under this chapter. A sheriff on receipt of the warrant must seize and impound all drilling machines and hoists owned or used by the person. A person from whom equipment is seized under this subdivision may file an action in district court for the purpose of establishing that the equipment was wrongfully seized.

Subd. 2. **Release.** The equipment must remain in the custody of the sheriff until the equipment is released under the order of a court or until the commissioner orders the sheriff to release the equipment.

**History:** 1989 c 326 art 3 s 46; 1991 c 355 s 50

### **103I.715 CRIMINAL PENALTIES.**

Subdivision 1. **Misdemeanors.** A person who violates a provision of this chapter is guilty of a misdemeanor.

Subd. 2. **Gross misdemeanors.** A person is guilty of a gross misdemeanor who:

- (1) willfully violates a provision of this chapter or order of the commissioner;
- (2) engages in the business of drilling or making wells, sealing wells, installing pumps or pumping equipment, or constructing elevator shafts without a license required by this chapter; or
- (3) engages in the business of exploratory boring without an exploratory borer's license under this chapter.

Subd. 3. **Prosecution and venue.** A violation of this chapter shall be prosecuted by the county attorney in the county where the violation occurred or is occurring. The trial shall be held in that county.

**History:** 1989 c 326 art 3 s 47

## ABBREVIATIONS LIST

AASHTO	American Association of State Highway and Transportation Officials
ABS	Acrylonitrile Butadiene Styrene
ACI	American Concrete Institute
API	American Petroleum Institute
ANSI	American National Standards Institute
ASME	American Society of Mechanical Engineers
ASTM	American Society for Testing and Materials
AWWA	American Water Works Association
CISPI	Cast Iron Soil Pipe Institute
DLI	Department of Labor and Industry
EBH	Environmental Bore Hole
EPA	Environmental Protection Agency (federal)
FEMA	Federal Emergency Management Agency
FIFRA	Federal Insecticide, Fungicide, and Rodenticide Act
FS	Federal Specifications (General Services Administration)
FT <sup>3</sup>	Cubic Feet
G.P.M.	Gallons Per Minute
ID	Inside Diameter
MDH	Minnesota Department of Health
MF	Membrane Filter (coliform test)
MGS	Minnesota Geological Survey
MPN	Most Probable Number (coliform test)
MPCA	Minnesota Pollution Control Agency
NPS	Nominal Pipe Size
NSF	NSF International (formerly (National Sanitation Foundation)
OD	Outside Diameter
OHWL	Ordinary High Water Level
PCA	Pollution Control Agency (Minnesota)
PFC	Perfluorochemical
PPB	Part Per Billion
PPM	Part Per Million
PSI	Pounds Per Square Inch
PVC	Polyvinyl Chloride
PWL	Pumping Water Level
RPZ	Reduced Pressure Zone (backflow preventer)
SDR	Standard Dimension Ratio
SWL	Static Water Level
UL	Underwriters Laboratory
USDA	United States Department of Agriculture
USP	United States Pharmacopoeia





**WELL MANAGEMENT SECTION  
ENVIRONMENTAL HEALTH DIVISION  
MINNESOTA DEPARTMENT OF HEALTH**

CENTRAL OFFICE STAFF  
625 North Robert Street,  
P.O. Box 64975  
St. Paul, MN 55164-0975  
Phone: 651/201-4600  
Fax: 651/201-4599

Dan Wilson, Manager  
Kim Benson-Johnson, Hydrologist, Local Programs, Monitoring Well Maint. Permits  
Mary Jo Connolly, Support, Cashier  
Mike Convery, Operations Unit Supervisor  
Kathy Dunaway, Support, Disclosures/Maintenance Permits  
Deb Grundtner, Support, Monitoring Wells/Maint. Permits, Variances, Sealing Records  
Mark Hoffman, Hydrologist, Monitoring Wells, Exploratory Borings, Heat Loops  
Mark Johnson, Enforcement Coordinator  
Mary Johnson, Support, Cashier, Enforcement, Construction Records  
Francine LaFayette, Support Staff Unit Supervisor, Contractor Licenses  
Norm Mofjeld, Hydrologist, Disclosures/Well Sealing  
Karen Mullally, Support, Disclosures, Water Quality Data  
Becky Renko, Receptionist  
Ed Schneider, Hydrologist, Variances, Community Well Plans  
Janice Stanger, Database Management

651/201-4600  
651/201-4583  
651/201-4585  
651/201-4586  
651/201-4587  
651/201-4588  
651/201-4589  
651/201-4590  
651/201-4591  
651/201-4592  
651/201-4593  
651/201-4594  
651/201-4595  
651/201-4596

Mark Malmanger, Northern Regional Supv. 218/308-2118  
Scott Longanecker, Well Standards Rep. 218/308-2123  
Kelly Jorgensen, Well Standards Rep. 218/308-2112  
Northwestern District  
Suite A  
705 Fifth Street Northwest  
Bemidji, MN 56601

Jeff Grugel, Hydrologist  
218/332-5148  
West Central District  
Suite 300  
1505 Pebble Lake Road  
Fergus Falls, MN 56537

H. Curtis Wunderlich, Hydrologist  
320/223-7329  
Keith Donabauer, Well Inspector  
320/223-7316  
Central District  
Midtown Square, Suite 212  
3333 West Division Street  
St. Cloud, MN 56301

Robert Nielsen, Hydrologist  
507/537-6071  
Tom Steffl, Well Standards Rep  
507/537-7109  
Southwestern District  
1400 East Lyon Street  
Marshall, MN 56258

Scott Longanecker, Well Standards Rep.  
218/723-4642  
Sandra Beck, Hydrologist  
218/723-4653  
Northeastern District  
Government Service Center, Rm. 703  
320 West Second Street  
Duluth, MN 55802

Ron Thompson, Metro Regional Supv. 651/201-3658  
Douglas Edson, Hydrologist 651/201-3659  
Patrick Sarafolean, Hydrologist 651/201-3962  
Steve Bennett, Well Standards Rep. 651/201-3963  
Metro District-Mailing Address:  
P.O. Box 64975, St. Paul, MN 55164-0975  
Street Address:  
1645 Energy Park Drive, St. Paul, MN 55108

Peter Zimmerman, Southern Regional Supv.  
507/206-2737  
Chris De Mattos, Hydrologist  
507/206-2722  
Southeastern District  
18 Wood Lake Drive Southeast  
Rochester, MN 55904

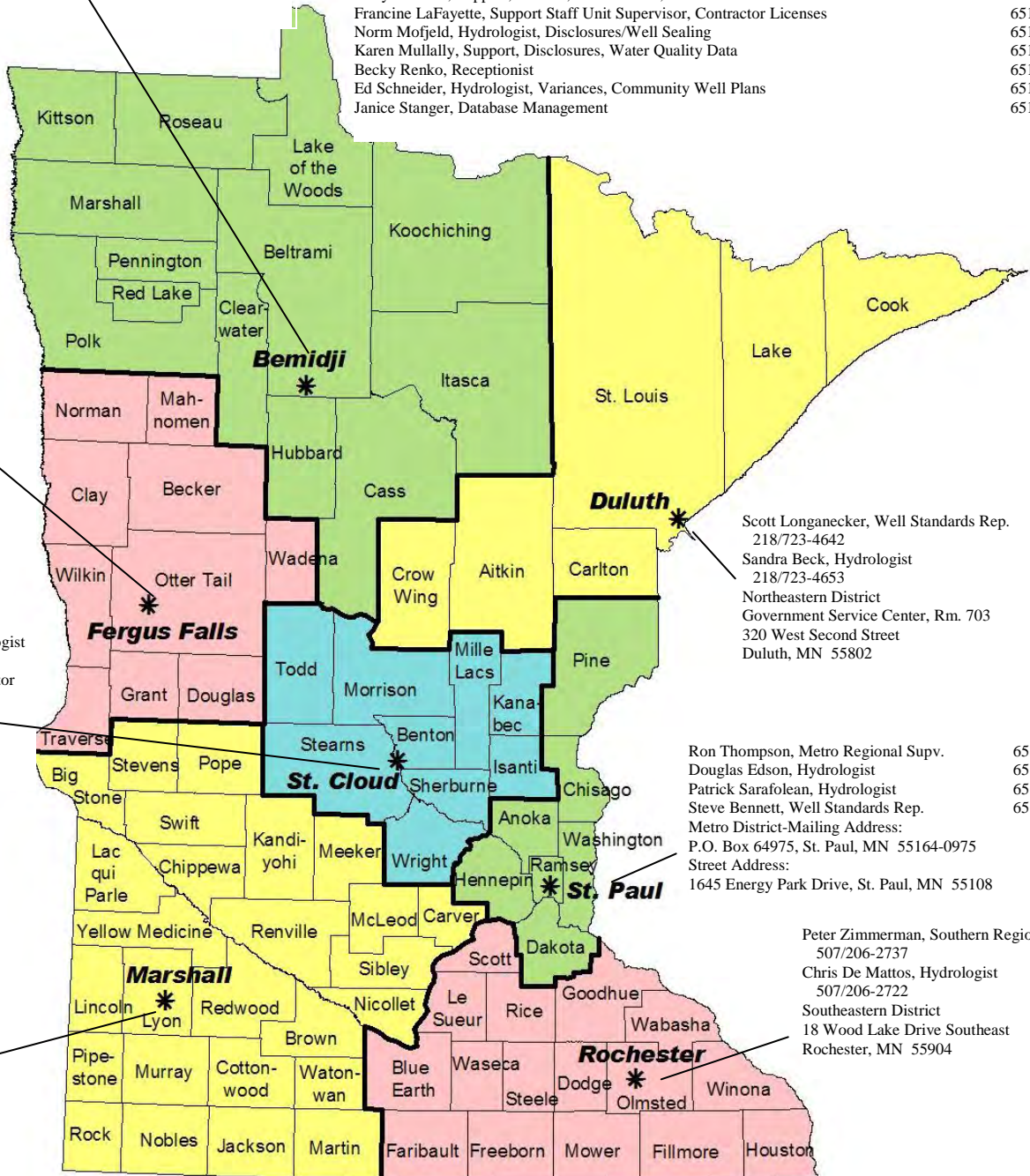

## STATE AGENCY PHONE NUMBERS, WEB SITES

Minnesota Board of Water and Soil Resources (BWSR), St. Paul	
General Information .....	651-296-3767
Web site.....	<a href="http://www.bwsr.state.mn.us">www.bwsr.state.mn.us</a>
Minnesota Department of Agriculture (MDA), St. Paul	
General Information .....	651-201-6000
Web site.....	<a href="http://www.mda.state.mn.us">www.mda.state.mn.us</a>
Minnesota Department of Health (MDH), St. Paul	
Well Management Section (wells and borings).....	651-201-4600
Drinking Water Protection (public water supplies).....	651-201-4700
Department Web Sites	
Department.....	<a href="http://www.health.state.mn.us">www.health.state.mn.us</a>
Well Management Section.....	<a href="http://www.health.state.mn.us/divs/eh/wells">www.health.state.mn.us/divs/eh/wells</a>
County Well Index.....	<a href="http://www.health.state.mn.us/divs/eh/cwi">www.health.state.mn.us/divs/eh/cwi</a>
Health Risk Limits .....	<a href="http://www.health.state.mn.us/divs/eh/risk/guidance/gw/table.html">www.health.state.mn.us/divs/eh/risk/guidance/gw/table.html</a>
Minnesota Department of Labor and Industry (DLI), St. Paul	
Plumbing .....	651-284-5067
Electrical.....	651-284-5026
Web site.....	<a href="http://www.dli.mn.gov/cclld.asp">www.dli.mn.gov/cclld.asp</a>
Minnesota Department of Natural Resources (DNR), St. Paul	
General Information .....	651-296-6157
Division of Waters (appropriations permits).....	651-259-5654
Web site.....	<a href="http://www.dnr.state.mn.us/waters">www.dnr.state.mn.us/waters</a>
Minnesota Department of Public Safety (DPS), St. Paul	
Driver and Vehicle Services Division .....	651-297-2126
Minnesota Duty Officer.....	651-649-5451
Toll free .....	800-422-0798
Web site.....	<a href="http://www.dps.state.mn.us">www.dps.state.mn.us</a>
Minnesota Department of Transportation (MnDOT), St. Paul	
General Information .....	651-296-3000
Web site.....	<a href="http://www.dot.state.mn.us">www.dot.state.mn.us</a>
Minnesota Geological Survey (MGS), St. Paul	
General Information .....	612-627-4780
Web site.....	<a href="http://www.mngs.umn.edu">www.mngs.umn.edu</a>
Minnesota Pollution Control Agency (MPCA), St. Paul	
General Information .....	612-296-6300
Toll free .....	800-657-3864
Web site.....	<a href="http://www.pca.state.mn.us">www.pca.state.mn.us</a>

## GROUNDWATER RELATED CONTACTS

### Gopher State One Call

General Information ..... 651-454-0002  
Toll free ..... 800-252-1166  
Web site ..... [www.gopherstateonecall.org](http://www.gopherstateonecall.org)

### Minnesota Ground Water Association (MGWA)

Web site ..... [www.mgwa.org](http://www.mgwa.org)

### Minnesota Water Well Association (MWWA)

General Information ..... 651-290-6270  
Web site ..... [www.mwwa.org](http://www.mwwa.org)

### U. S. Environmental Protection Agency (EPA), Region 5

General Information ..... 312-353-2000  
Toll free ..... 800-621-8431  
Web site ..... [www.epa.gov/region5](http://www.epa.gov/region5)

### U. S. Geological Survey (Mounds View)

General Information ..... 763-783-3100  
Toll Free ..... 888-275-8747  
Web site ..... [mn.water.usgs.gov](http://mn.water.usgs.gov)

### University of Minnesota Water Resources Center

General Information ..... 612-624-9282  
Web site ..... [wrc.umn.edu](http://wrc.umn.edu)

## **DELEGATED WELL PROGRAMS**

The MDH has delegated portions of the state Well Program to several local boards of health. The commissioner of health may enter into an agreement to delegate all or part of the inspection, reporting, and enforcement duties pertaining to the construction, repair, and sealing of wells and elevator borings. The department has developed four separate delegation agreements whereby the MDH may delegate: (1) the construction, repair and sealing of water-supply wells except community public-water-supply wells, (2) sealing of water-supply wells except community public-water-supply wells, (3) construction, repair and sealing of dewatering wells, or (4) construction, repair and sealing of monitoring wells. The local board of health may enter into one or more of the agreements.

- Inspection and enforcement of environmental bore holes, vertical heat exchangers, exploratory borings, and community public water-supply wells cannot be delegated.
- At the present time, local units of government have not been delegated responsibility for elevator borings.
- Local units of government may not license contractors.
- Variance requests for wells in delegated counties or cities must be first approved by the MDH.
- Local programs may enact ordinances which require higher fees than those established by the state, require more restrictive standards, and require permits instead of notifications.

If you have questions regarding well construction, well location, or well sealing in a city or county listed below please contact the local program staff. If the city or county is not listed, please call the MDH district office nearest you.

## **DELEGATED WELL PROGRAMS**

**2010**

### **City of Bloomington**

Mike Thissen/ Erik Solie  
Jeff Luedeman  
Bloomington Environmental Services  
1800 West Old Shakopee Road  
Bloomington, Minnesota 55431  
952-563-8934  
Fax: 952-563-8949  
E-mail: mthissen@ci.bloomington.mn.us  
esolie@ci.bloomington.mn.us  
jluedeman@ci.bloomington.mn.us

Water Well Program  
Monitoring Well Program  
Dewatering Well Program

### **City of Minneapolis**

Tom Frame/Alison Fong  
City of Minneapolis  
250 South Fourth Street, Room 414  
Minneapolis, Minnesota 55415  
612-673-5807  
Fax: 612-673-2635  
E-mail: tom.frame@ci.minneapolis.mn.us  
alison.fong@ci.minneapolis.mn.us

Water Well Program  
Monitoring Well Program

### **Blue Earth County**

Tim Grant/Peter Otterness  
Blue Earth County Government Center  
410 South 5th Street, 3rd Floor  
P.O. Box 3566  
Mankato, Minnesota 56002-3566  
507-304-4381  
Fax: 507-304-4431  
E-mail: tim.grant@co.blue-earth.mn.us  
peter.otterness@co.blue-earth.mn.us

Water Well Program

### **Dakota County**

Jeff Luehrs/Bill Olsen  
Michael Rutten/Vanessa Demuth  
Dakota County Environmental Services  
14955 Galaxie Avenue West  
Apple Valley, Minnesota 55124  
952-891-7556  
Fax: 952-891-7588  
E-mail: jeff.luehrs@co.dakota.mn.us  
bill.olsen@co.dakota.mn.us  
michael.rutten@co.dakota.mn.us  
vanessa.demuth@co.dakota.mn.us

Water Well Program  
Monitoring Well Program  
Dewatering Well Program

### **Goodhue County**

Jason Petersen/Pam Holst  
Goodhue County Environmental Health Department  
512 West 6th Street, P.O. Box 408  
Red Wing, Minnesota 55066  
651-385-6130 or 800-950-2142  
Fax: 651-385-6472  
E-mail: jason.petersen@co.goodhue.mn.us  
pam.holst@co.goodhue.mn.us

Water Well Program

### **LeSueur County**

Matt Finkenbiner  
LeSueur-Waseca Community Health Services  
88 South Park Street  
LeCenter, Minnesota 56057  
507-357-8231  
Fax: 507-357-4223  
E-mail: mfinkenbiner@co.le-sueur.mn.us

Water Well Program

**Olmsted County**

Dennis Manning/Richard Alwes  
Rochester-Olmsted Consolidated Planning  
2122 Campus Drive Southeast  
Rochester, Minnesota 55904  
507-328-7111  
Fax: 507-328-7958  
E-mail: manning.dennis@co.olmsted.mn.us  
alwes.richard@co.olmsted.mn.us

Water Well Program  
Monitoring Well Program  
Dewatering Well Program

**Wabasha County**

Darrin Thompson  
Wabasha County Public Health Services  
411 Hiawatha Drive East  
Wabasha, Minnesota 55981  
651-565-5200  
Fax: 651-565-2637  
E-mail: dthompson@co.wabasha.mn.us

Water Well Program

**Waseca County**

Cheri Lewer/Sarah DeLong  
LeSueur-Waseca Community Health Services  
299 Johnson Avenue Southwest  
Waseca, Minnesota 56093  
507-835-0655  
Fax: 507-835-0687  
E-mail: cheri.lewer@co.waseca.mn.us  
sarah.delong@co.waseca.mn.us

Water Well Program

**Winona County**

Ross Dunsmoor  
Winona County Environmental Services  
225 West Second Street  
Winona, Minnesota 55987  
507-457-6405  
Fax: 507-457-6465  
E-mail: rdunsmoor@co.winona.mn.us

Water Well Program  
Monitoring Well Program  
Dewatering Well Program

## COUNTY PLANNING, ZONING, ENVIRONMENTAL OFFICES

County governments may regulate a number of planning, zoning, and environmental activities such as building, land use and zoning, sewage treatment (SSTS), feedlots, water resources, and other activities. Counties vary as to which activities are regulated, and whether the programs are contained in a single department, or separated into multiple departments. Some townships and cites also regulate various environmental activities.

The following is a list of county planning, zoning, and/or environmental contacts.

Aitkin County  
Aitkin County Courthouse  
Room 118  
209 Second Street Northwest  
Aitkin, Minnesota 56431  
218-927-7342

Anoka County  
2100 – 3rd Avenue  
Anoka, Minnesota 55303  
612-422-7066

Becker County  
Becker County Courthouse  
915 Lake Avenue  
P.O. Box 787  
Detroit Lakes, Minnesota 56501  
218-846-7314

Beltrami County  
Beltrami County Administration Building  
701 Minnesota Avenue Northwest  
Bemidji, Minnesota 56601  
218-333-4158

Benton County  
Benton County Courthouse  
531 Dewey Street  
P.O. Box 129  
Foley, Minnesota 56329  
320-968-5065

Big Stone County  
Big Stone County Courthouse  
20 Southeast Second Street  
Ortonville, Minnesota 56278  
320-839-6253

Blue Earth County  
Blue Earth County Planning and Zoning  
P.O. Box 3566  
Mankato, Minnesota 56001  
507-304-4381

Brown County  
P.O. Box 248  
New Ulm, Minnesota 56073  
507-233-6640

Carlton County  
Carlton County Courthouse,  
301 Walnut  
P.O. Box 220  
Carlton, Minnesota 55718  
218-384-9176

Carver County  
Carver County Government Center  
600 East Fourth Street  
Chaska, Minnesota 55318  
952-361-1820

Cass County  
Cass County Courthouse,  
303 Minnesota Avenue West  
P.O. Box 3000  
Walker, Minnesota 56484  
218-547-7241

Chippewa County  
629 North 11th Street  
Montevideo, Minnesota 56265  
320-269-6231

Chisago County  
Room 243 Government Center  
313 North Main Street  
Center City, Minnesota 55012  
651-213-0447

Clay County  
807 North 11th Street  
P.O. Box 280  
Moorhead, Minnesota 56560  
218-299-5002

Clearwater County  
213 North Main Avenue  
Bagley, Minnesota 56621  
218-694-6183

Cook County  
Cook County Courthouse  
411 – Second Street  
Grand Marais, Minnesota 55604  
218-387-3630

Cottonwood County  
235 Ninth Street  
Windom, Minnesota 56101  
507-831-2060

Crow Wing County  
Crow Wing County Courthouse  
326 Laurel Street  
Brainerd, Minnesota 56401  
218-824-1125

Dakota County  
14955 Galaxie Avenue West  
Apple Valley, Minnesota 55124  
612-891-7030

Dodge County  
Dodge County Courthouse  
22 East Sixth Street  
Mantorville, Minnesota 55955  
507-635-6272

Douglas County  
305 Eighth Avenue West  
Alexandria, Minnesota 56308  
320-762-3863

Faribault County  
Suite 8  
415 South Grove Street  
Blue Earth, Minnesota 56013  
507-526-2388

Fillmore County  
P.O. Box 655  
101 Fillmore Street  
Preston, Minnesota 55965  
507-765-3325

Freeborn County  
Freeborn County Courthouse  
411 South Broadway  
Albert Lea, Minnesota 56007  
507-377-5186

Goodhue County  
Goodhue County Government Center  
509 West Fifth Street  
Red Wing, Minnesota 55066  
612-385-3102

Grant County  
Grant County Courthouse  
10 First Street Northwest  
Elbow Lake, Minnesota 56531  
218-685-4969

Houston County  
Houston County Courthouse  
304 South Marshall Street  
Caledonia, Minnesota 55921  
507-725-5800

Hubbard County  
Hubbard County Courthouse  
301 Court Avenue  
Park Rapids, Minnesota 56470  
218-732-3890

Isanti County  
555 18th Avenue Southwest  
Cambridge, Minnesota 55008  
763-689-5165

Itasca County  
123 Northeast Fourth Street  
Grand Rapids, Minnesota 55744  
218-327-2857

Jackson County  
405 – Fourth Street  
Jackson, Minnesota 56143  
507-847-2240



Kanabec County  
Suite 291  
18 North Vine Street  
Mora, Minnesota 55051  
320-679-6456

Kandiyohi County  
400 Southwest Benson Avenue  
Willmar, Minnesota 56201  
320-231-6532

Kittson County  
Suite 106  
410 South Fifth Street  
Hallock, Minnesota 56728  
218-843-2655

Koochiching County  
715 Fourth Street  
International Falls, Minnesota 56649  
218-283-1155

Lac Qui Parle County  
Lac Qui Parle County Courthouse  
Suite 11  
600 Sixth Street  
Madison, Minnesota 56256  
612-598-7444

Lake County  
Lake County Courthouse  
601 Third Avenue  
Two Harbors, Minnesota 55616  
218-834-8327

Lake of the Woods County  
Lake of the Woods County Government Center  
206 Eighth Avenue Southeast  
Baudette, Minnesota 56623  
218-634-1945

Le Sueur County  
Le Sueur County Courthouse  
88 South Park Avenue  
Le Center, Minnesota 56057  
507-357-2251

Lincoln County  
Lincoln County Courthouse  
221 North Wallace Avenue  
P. O. Box 66  
Ivanhoe, Minnesota 56142  
507-694-1344

Lyon County  
504 Fairgrounds Road  
Marshall, Minnesota 56258  
507-532-8206

McLeod County  
McLeod County Courthouse  
830 - 11th Street East  
Glencoe, Minnesota 55336  
320-864-5551

Mahnomen County  
P. O. Box 160  
Mahnomen, Minnesota 56567  
218-935-5639

Marshall County  
Suite 3  
208 East Colvin  
Warren, Minnesota 56762  
218-745-4217

Martin County  
Martin County Courthouse  
Room 104  
201 Lake Avenue  
Fairmont, Minnesota 56031  
507-238-3242

Meeker County  
Meeker County Courthouse  
325 Sibley Avenue North  
Litchfield, Minnesota 55355  
320-693-5290

Mille Lacs County  
Mille Lacs County Courthouse Annex  
635 Second Street Southeast  
Milaca, Minnesota 56353  
320-983-8205

Morrison County  
Morrison County Government Center  
213 Southeast First Avenue  
Little Falls, Minnesota 56345  
320-632-2941

Mower County  
1105 – 1/2 Northeast Eighth Avenue  
Austin, Minnesota 55912  
507-437-9527

Murray County  
Murray County Courthouse  
2500 – 28th Street  
P. O. Box 57  
Slayton, Minnesota 56172  
507-836-6148

Nicollet County  
Nicollet County Government Center  
501 South Minnesota Avenue  
St. Peter, Minnesota 56082  
507-934-0250

Nobles County  
315 10th Street  
Worthington, Minnesota 56187  
507-376-3109

Norman County  
816 East Main Street  
Ada, Minnesota 56510  
218-784-5493

Olmsted County  
Rochester-Olmsted Planning Department  
Suite 100  
2122 Campus Drive Southeast  
Rochester, Minnesota 55904  
507-285-8232

Otter Tail County  
Government Services Center  
540 Fir Avenue West  
Fergus Falls, Minnesota 56537  
218-998-8095

Pennington County  
Pennington County Courthouse  
First and Main  
Thief River Falls, Minnesota 56701  
218-683-7030

Pine County  
1610 Highway 23 North  
Sandstone, Minnesota 55072  
320-245-6707

Pipestone County  
Suite 13  
119 Second Avenue South  
Pipestone, Minnesota 56164  
507-825-5024

Polk County  
Polk County Courthouse  
612 North Broadway  
Crookston, Minnesota 56716  
218-281-5700

Pope County  
130 East Minnesota Avenue  
Glenwood, Minnesota 56334  
320-634-5715

Red Lake County  
Red Lake County Courthouse  
124 Langevin Avenue  
Red Lake Falls, Minnesota 56750  
218-253-4121

Redwood County  
P.O. Box 130  
Redwood Falls, Minnesota 56283  
507-637-4023

Renville County  
410 East DePue Avenue  
Olivia, Minnesota 56277  
320-523-3768

Rice County  
320 Northwest Third Street  
Faribault, Minnesota 55021  
507-332-6100

Rock County  
Suite 5  
311 West Gabrielson Road  
Luverne, Minnesota 56156  
507-283-8862

Roseau County  
Roseau County Courthouse  
Roseau, Minnesota 56751  
218-463-1282

St. Louis County  
Suite 100  
227 West First Street  
Duluth, Minnesota 55802  
218-725-5000

Scott County  
200 Fourth Avenue Wwest  
Shakopee, Minnesota 55379  
952-496-8475

Sherburne County  
Sherburne County Government Center  
13880 Highway 10  
Elk River, Minnesota 55330  
763-241-2900

Sibley County  
Sibley County Courthouse  
400 Court Street  
Gaylord, Minnesota 55334  
507-237-4091

Stearns County  
Stearns County Administration Center  
705 Courthouse Square  
P. O. Box 1107  
St. Cloud, Minnesota 56303  
320-656-3613

Steele County  
630 Florence Avenue  
P.O. Box 890  
Owatonna, Minnesota 55060  
507-444-7475

Stevens County  
400 Colorado Avenue  
P.O. Box 530  
Morris, Minnesota 56267  
320-589-7420

Swift County  
1000 Industrial Drive  
P. O. Box 288  
Benson, Minnesota 56215  
320-843-2356

Todd County  
Suite 201  
215 First Avenue South  
Long Prairie, Minnesota 56347  
320-732-4420

Traverse County  
Room 205  
1700 Third Avenue South  
Wheaton, Minnesota 56296  
320-563-4411

Wabasha County  
625 Jefferson Avenue  
Wabasha, Minnesota 55981  
651-565-3062

Wadena County  
Wadena County Courthouse  
415 South Jefferson Street  
Wadena, Minnesota 56482  
218-631-7604

Waseca County  
300 North State Street  
Waseca, Minnesota 56093  
507-835-0630

Washington County  
Washington County Government Center  
14949 62nd Street North  
Stillwater, Minnesota 55082-0006  
651-430-6875

Watonwan County  
Suite 20  
108 Eighth Street South  
St. James, Minnesota 56081  
507-375-1275

Wilkin County  
505 Eighth Street South  
Breckenridge, Minnesota 56520  
218-643-5815

Winona County  
177 Main Street  
Winona, Minnesota 55987  
507-457-6335

Wright County  
Wright County Government Center  
10 Second Street Northwest  
Buffalo, Minnesota 55313  
763-682-7693

Yellow Medicine County  
Yellow Medicine County Courthouse  
415 Ninth Avenue  
Granite Falls, Minnesota 56241  
320-564-3132

## VOLUME OF CASING OR HOLE

Diameter of Casing (I.D.) or Hole (Inches)	Gallons per Foot of Depth	Cubic Feet per Foot of Depth	Sacks of Cement per Foot of Depth*	Feet of Hole Filled per Sack of Cement*
1 1-1/2	0.041 0.092	0.0055 0.0123	.0043 .0096	232.7 104.1
2 2-1/2	0.163 0.255	0.0218 0.0341	.0170 .0266	58.72 37.54
3 3-1/2	0.367 0.500	0.0491 0.0668	.0384 .0522	26.07 19.16
4 4-1/2	0.653 0.826	0.0873 0.1104	.0682 .0863	14.66 11.59
5 5-1/2	1.020 1.234	0.1364 0.1650	.1066 .1289	9.384 7.757
6 7	1.469 2.000	0.1963 0.2673	.1534 .2088	6.521 4.789
8 9	2.611 3.305	0.3491 0.4418	.2727 .3451	3.666 2.897
10 11	4.080 4.937	0.5454 0.6600	.4261 .5156	2.347 1.939
12 13	5.875 6.895	0.7854 0.9217	.6136 .7211	1.630 1.387
14 15	8.000 9.180	1.069 1.227	.8351 .9586	1.197 1.043
16 17	10.44 11.79	1.396 1.576	1.090 1.231	.9169 .8122
18 19	13.22 14.73	1.767 1.969	1.380 1.538	.7244 .6501
20 22	16.32 19.75	2.182 2.640	1.705 2.063	.5866 .4848
24 26	23.50 27.58	3.142 3.687	2.455 2.881	.4074 .3472
28 30	32.00 36.72	4.276 4.909	3.341 3.835	.2993 .2607
32 34	41.78 47.16	5.585 6.305	4.363 4.926	.2292 .2030
36	52.88	7.069	5.523	.1811

\* Cement calculations based on 6 gallons of water per sack (94 lbs.) of cement yielding 1.28 cubic feet or 9.5 gallons.

**ANNULAR VOLUME BETWEEN A PLAIN-END CASING AND AN OPEN HOLE**

Casing Outside Diameter (O.D.) Inches	Diameter of Hole Inches	Gallons per Lineal Foot	Lineal Feet per Gallon	Cubic Feet per Lineal Foot	Lineal Feet per Cubic Foot
2-3/8 (2" nominal casing size)	4	.423	2.36	.056	17.7
	5	.790	1.27	.106	9.47
	<b>5-3/8*</b>	.949	1.05	.127	7.88
	6	1.24	.807	.166	6.04
	7	1.77	.565	.236	4.23
	8	2.38	.420	.318	3.14
4-1/2 (4" nominal casing size)	5	.194	5.16	.026	38.6
	6	.643	1.55	.086	11.6
	7	1.17	.853	.157	6.38
	<b>7-1/2*</b>	1.47	.681	.196	5.09
	8	1.78	.560	.239	4.19
	9	2.48	.403	.331	3.02
	10	3.25	.307	.435	2.30
5-1/2 (5" nominal casing size)	6	.235	4.26	.031	31.9
	7	.765	1.31	.102	9.78
	8	1.38	.726	.184	5.43
	<b>8-1/2*</b>	1.71	.584	.230	4.36
	9	2.07	.483	.277	3.61
	10	2.84	.351	.380	2.63
	12	4.64	.215	.620	1.61
6-5/8 (6" nominal casing size)	7	.208	4.80	.028	35.9
	8	.820	1.22	.110	9.12
	9	1.51	.660	.202	4.94
	<b>9-5/8*</b>	1.99	.503	.266	3.76
	10	2.29	.437	.306	3.27
	12	4.08	.245	.546	1.83
8-5/8 (8" nominal casing size)	9	.270	3.71	.036	27.7
	10	1.05	.957	.140	7.16
	11	1.90	.526	.254	3.94
	<b>11-5/8*</b>	2.48	.404	.331	3.02
	12	2.84	.352	.380	2.63
	14	4.96	.201	.663	1.51
10-3/4 (10" nominal casing size)	12	1.16	.862	.155	6.45
	13	2.18	.459	.291	3.43
	<b>13-3/4*</b>	2.99	.333	.401	2.49
	16	5.73	.174	.766	1.30
	18	8.50	.118	1.14	.880
12-3/4 (12" nominal casing size)	14	2.04	.490	.273	3.66
	15	2.55	.393	.340	2.94
	<b>15-3/4*</b>	3.49	.287	.466	2.14
	18	6.59	.152	.880	1.14
	20	9.69	.103	1.29	.772

**ANNULAR VOLUME BETWEEN A PLAIN-END CASING AND AN OPEN HOLE  
(Continued)**

Casing Outside Diameter (O.D.) Inches	Diameter of Hole Inches	Gallons per Lineal Foot	Lineal Feet per Gallon	Cubic Feet per Lineal Foot	Lineal Feet per Cubic Foot
14 (14" nominal casing size)	15	1.18	.845	.158	6.32
	16	2.45	.408	.327	3.06
	17	3.79	.222	.601	1.66
	<b>17-1/2**</b>	4.50	.241	.554	1.80
	18	5.22	.191	.698	1.43
	20	8.32	.120	1.11	.899
16 (16" nominal casing size)	17	1.35	.743	.180	5.55
	18	2.77	.360	.371	2.69
	19	4.28	.233	.573	1.74
	<b>19-1/2**</b>	5.07	.197	.677	1.47
	20	5.87	.170	.784	1.22
	22	9.30	.107	1.24	.804
20 (20" nominal casing size)	21	1.67	.598	.224	4.47
	22	3.43	.292	.458	2.18
	23	5.26	.190	.704	1.42
	<b>23-1/2**</b>	6.21	.161	.830	1.20
	24	7.18	.139	.960	1.04
	26	11.3	.088	1.50	.664
24 (24" nominal casing size)	25	1.99	.502	.267	3.74
	26	4.08	.245	.545	1.83
	27	6.24	.160	.834	1.20
	<b>27-1/2**</b>	7.35	.136	.983	1.02
	28	8.49	.118	1.13	.885
	30	13.2	.076	1.77	.565

\* Hole size 3.0 inches larger than the casing.

\*\* Hole size 3.5 inches larger than the casing.

**ANNULAR VOLUME BETWEEN TWO PLAIN-END  
SCHEDULE 40 OR STANDARD WEIGHT STEEL CASINGS**

Casing Combination outer casing x inner casing (nominal casing size)	Annular Volume (cubic feet/linear feet)	1 Cubic Yard Fills (linear feet)
6 x 2	.1755	152.1 ft.
8 x 4	.2386	113.0 ft.
10 x 5	.3785	71.0 ft.
10 x 6	.3082	87.6 ft.
12 x 6	.5460	49.5 ft.
12 x 8	.3797	71.1 ft.
14 x 8	.5518	49.0 ft.
16 x 8	.8627	31.3 ft.
16 x 10	.6381	42.3 ft.
18 x 10	.9926	27.2 ft.
18 x 12	.7363	36.7 ft.
20 x 12	1.1344	23.8 ft.
20 x 14	.9520	28.4 ft.
22 x 16	1.0660	25.3 ft.
24 x 16	1.5862	17.0 ft.
24 x 18	1.1811	22.9 ft.
30 x 24	1.5247	17.7 ft.



## INNER AND OUTER CASING COMBINATIONS

Minnesota Rules, part 4725.2250, subpart 8 requires the inside diameter of an outer casing to be at least 3.0 inches larger than the outside diameter of the inner casing, couplings or bell-end, whichever is larger, for inner casings with 12 inches inside diameter and smaller. The inside diameter of an outer casing must be at least 3.5 inches larger than the outside diameter of the inner casing, couplings or bell end, whichever is larger, for inner casings larger than 12 inches inside diameter and over 100 feet deep.

The following chart lists inner/outer casing combinations for an outer steel casing and common inner casing materials. The chart does not list all combinations or all materials. **THE CHART SHOULD BE USED AS A GENERAL GUIDE ONLY.** Other combinations, or other approved casing materials, are allowed as long as the annular space requirements are met.

OUTER STEEL CASING, NOMINAL PIPE SIZE	MAXIMUM SIZE INNER CASING ALLOWED NOMINAL PIPE SIZE			
	Plain-end Steel (Sch. 40, Std. Wt)	Threaded and Coupled Steel (Sch. 40, Std. Wt)	Bell-end Plastic SDR 21	Flush Threaded Plastic Sch 40
5	1-1/2	1-1/4		
6	2-1/2	2	2*	2-1/2
8	4	3-1/2	4**	4-1/2
10	6	5	5	6
12	8	6	6-1/8	8
14	8	8	8	
16	10	10	10	
18	12	10	12***	
20	14	14		
22	16	16		
24	18	18		
26	20	20		
28	22			
30	24			
32	26			
36	30			

\* Schedule 40 2-inch plastic bell and spigot casing is manufactured that meets the ASTM standard, exceeds a 200 psi rating, and meets the requirements of the rule.

\*\* 4-inch bell and spigot plastic casing must have a bell outside diameter of 5.0 inches or less, and meet the 200 psi pressure rating and SDR 21 minimum to be installed inside an 8-inch casing.

\*\*\* All plastic casing must meet the requirements in rule, including the minimum pressure and SDR rating. A 3.5-inch difference between the O.D. of the inner casing bell-end for inner casings that are 12 inches and larger and deeper than 100 feet, and the outer casing I.D. is required. SDR 21 casing is generally not available larger than 12 inches.

Pipe Size	O.D. in Inches	ANSI PIPE SCHEDULES													
		5	10	20	30	40	STD	60	80	E.H.	100	120	140	160	DbI e. E.H.
1/8	.405	.035 .1383	.049 .1863			.068 .2447	.068 .2447			.095 .3145	.095 .3145				
1/4	.540	.049 .2570	.065 .3297			.088 .4248	.088 .4248			.119 .5351	.119 .5351				
3/8	.675	.049 .3276	.065 .4235			.091 .5676	.091 .5676			.126 .7388	.126 .7388				
1/2	.840	.065 .5383	.083 .6710			.109 .8510	.109 .8510			.147 1.088	.147 1.088			.187 1.304	.294 1.714
3/4	1.050	.065 .6838	.083 .8572			.113 1.131	.113 1.131			.154 1.474	.154 1.474			.218 1.937	.308 2.441
1	1.315	.065 .8678	.109 1.404			.133 1.679	.133 1.679			.179 2.172	.179 2.172			.250 2.844	.358 3.659
1-1/4	1.660	.065 1.107	.109 1.806			.140 2.273	.140 2.273			.191 2.997	.191 2.997			.250 3.765	.382 5.214
1-1/2	1.900	.065 1.274	.109 2.085			.145 2.718	.145 2.718			.200 3.631	.200 3.631			.281 4.859	.400 6.408
2	2.375	.065 1.604	.109 2.638			.154 3.653	.154 3.653			.218 5.022	.218 5.022			.343 7.444	.436 9.029
2-1/2	2.875	.083 2.475	.120 3.531			.203 5.793	.203 5.793			.276 7.661	.276 7.661			.375 10.01	.552 13.70
3	3.5	.083 3.029	.120 4.332			.216 7.576	.216 7.576			.300 10.25	.300 10.25			.437 14.32	.600 18.58
3-1/2	4.0	.083 3.472	.120 4.973			.226 9.109	.226 9.109			.318 12.51	.318 12.51				.636 22.85
4	4.50	.083 3.915	.120 5.613			.237 10.79	.237 10.79	.281 12.66	.337 14.98	.337 14.98		4.37 19.01		.531 22.51	.674 27.54
4-1/2	5.0					.247 12.53				.355 17.61					.710 32.53
5	5.563	.109 6.349	.134 7.770			.258 14.62	.258 14.62		.375 20.78	.375 20.78		.500 27.04		.625 32.96	.750 38.55
6	6.625	.109 7.585	.134 9.289			.280 18.97	.280 18.97		.432 28.57	.432 28.57		.562 36.39		.718 45.30	.864 53.16
7	7.625					.301 23.57				.500 38.05					.875 63.08
8	8.625	.109 9.914	.148 13.40	.250 22.36	.277 24.70	.322 28.55	.322 28.55	.406 35.64	.500 43.39	.500 43.39	.593 50.87	.718 60.93	.812 67.76	.906 74.69	.875 72.42
9	9.625					.342 33.90				.500 48.72					
10	10.75	.134 15.19	.165 18.70	.250 28.04	.307 34.24	.365 40.48	.365 40.48	.500 54.74	.593 64.33	.500 54.74	.718 76.93	.843 89.20	1.000 104.1	1.125 115.7	
11	11.75					.375 45.55				.500 60.07					
12	12.75	.165 22.18	.180 24.20	.250 33.38	.330 43.77	.406 53.53	.375 49.56	.562 73.16	.687 88.51	.500 65.42	.843 107.2	1.000 125.5	1.125 139.7	1.312 160.3	
14	14.0		.250 36.71	.312 45.68	.375 63.37	.437 63.37	.375 54.57	.593 84.91	.750 106.1	.500 72.09	.937 130.7	1.093 150.7	1.250 170.2	1.406 189.1	
16	16.0		.250 42.05	.312 52.36	.375 54.57	.500 82.77	.375 62.58	.656 107.5	.843 136.5	.500 82.77	1.031 164.8	1.218 192.3	1.437 223.5	1.593 245.1	
18	18.0		.250 47.39	.312 59.03	.437 82.06	.562 104.8	.375 70.59	.750 138.2	.937 170.8	.500 93.45	1.156 208.0	1.375 244.1	1.562 274.2	1.781 308.5	
20	20.0		.250 52.73	.375 78.60	.500 104.1	.593 122.9	.375 78.60	.812 166.4	1.031 208.9	.500 104.1	1.280 256.1	1.500 296.4	1.750 341.1	1.968 379.0	
22	22.0		.250 58.07	.375 86.61	.500 114.8		.375 86.61	.875 197.4	1.125 250.8	.500 114.8	1.375 302.9	1.625 353.6	1.875 403.0	2.125 451.1	
24	24.0		.250 63.41	.375 94.62	.562 140.8	.687 171.2	.375 94.62	.968 238.1	1.218 296.4	.500 125.5	1.531 367.4	1.812 429.4	2.062 483.1	2.343 541.9	

**BOLD FIGURES** – Wall Thickness in Inches

**FIGURES** – Wt. per Ft. in Pounds

## ESTIMATING FLOW FROM VERTICAL PIPE OR CASING

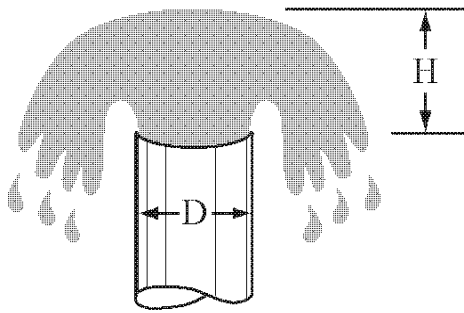

The approximate flow from vertical pipes or casings can be determined by measuring the maximum height (H) in inches to which the water column rises above the pipe, and the inside diameter of the pipe (D) in inches.

The flow in gallons per minute is given in the following table for different sizes of standard pipe and for different heights of the water column (H).

WATER COLUMN HEIGHT (H) in Inches	WATER FLOW IN GALLONS PER MINUTE							
	Nominal Diameter (D) of Standard Pipe (Inches)							
	2	3	4	5	6	7	8	10
3	35	77	135	217	311	425	569	950
3-1/2	38	85	149	238	341	465	626	1055
4	41	92	161	252	369	503	687	1115
4-1/2	44	98	172	270	396	540	733	1200
5	47	104	182	286	420	575	779	1280
5-1/2	49	109	192	301	444	606	825	1350
6	52	115	202	316	469	638	872	1415
6-1/2	54	121	211	331	490	667	913	1475
7	57	126	219	345	509	700	949	1530
8	61	135	236	370	548	751	1025	1640
9	65	144	251	396	585	802	1095	1740
10	69	153	265	418	621	850	1155	1840
12	76	169	294	463	685	933	1275	2010
14	83	184	319	502	740	1020	1380	2170
16	89	197	342	540	796	1090	1480	2320
18	95	209	364	575	845	1160	1560	2460
20	101	221	386	607	890	1225	1645	2600
25	113	249	433	680	998	1375	1840	2900
30	124	273	476	746	1095	1505	2010	3180
35	135	298	516	810	1175	1630	2160	3420
40	145	318	551	865	1270	1745	2320	3680

FOR EXAMPLE: If the water column height (H) is 4 inches above a 4-inch diameter casing, the well is flowing at 161 gallons per minute.

For other pipe sizes and heights of water columns, use the formula:

$$\text{GPM} = 5.68 \times C \times D^2 \times \%H$$

where GPM = gallons per minute; C = a constant varying from 0.87 to 0.97 for pipes of 2 to 6 inches in diameter and heights from 6 to 24 inches; D = inside diameter of pipe in inches; and H = height of water column in inches.

# CALCULATING THE DISCHARGE FROM FLOWING WELLS OR BORINGS

## ESTIMATING FLOW FROM HORIZONTAL OR INCLINED PIPES

### FULL PIPES

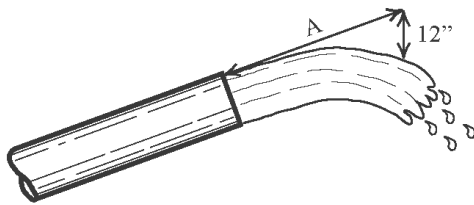
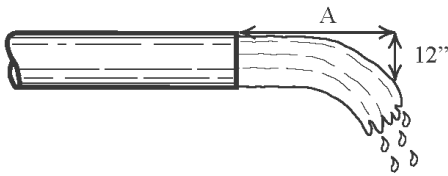

A fairly close determination of the flow volume from full open pipes may be made by measuring the distance the stream of water travels parallel to the pipe before dropping 12 inches vertically.

The inside diameter of the pipe must be measured, as well as the distance (A) the water stream travels (in inches) parallel to the pipe before dropping 12 inches vertically.

The flow, in gallons per minute, equals the distance (A) in inches multiplied by a constant (K) obtained from the following table:

PIPE INSIDE DIAMETER

	2	2½	3	4	5	6	7	8	9	10	12	14	16
K	2.3	5.1	7.3	13.1	20.4	29.4	40.0	52.3	66.2	81.7	118	160	209

FOR EXAMPLE: If the distance A (to drop 12 inches) is 8 inches for a 6 inch diameter pipe, the flow is  $8 \times 29.4 = 235.2$  gallons per minute.

# CALCULATING THE DISCHARGE FROM FLOWING WELLS OR BORINGS

## ESTIMATING FLOW FROM HORIZONTAL OR INCLINED PIPES

### PARTIALLY FILLED PIPES

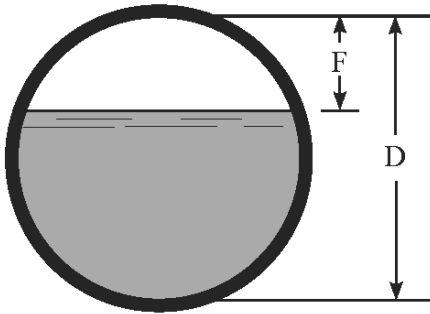

For partially filled pipes, measure the freeboard (F) and the inside diameter (D) and calculate the ratio of F/D (in percent). Measure the stream as explained for full pipes and calculate the discharge. The actual discharge will be approximately the value for a full pipe of the same diameter multiplied by the correction factor from the following table:

	F/D Percent										
	5	10	20	30	40	50	60	70	80	90	100
Correction Factor	.981	.948	.858	.747	.627	.500	.375	.253	.142	.052	.000

FOR EXAMPLE:

If a 4 inch pipe is 1/2 full (F = 2, D = 4, F/D = 2/4 = 0.5) and the distance A (to drop 12 inches) is 8 inches, the flow is estimated by  $A \times K \times \text{Factor} \approx (8)(13.1)(0.5) = \text{approximately } 52.4 \text{ gallons per minute.}$

### FLOW RATE CONVERSION TABLE

Gallons per Minute	Gallons per Day	Cubic Feet per Second
1	1,440	0.002
1.9*	2,740	0.004
5	7,200	0.011
6.9	10,000*	0.015
10	14,400	0.022
20	28,800	0.045
30	43,200	0.067
40	57,600	0.089
50	72,000	0.111
70**	100,800	0.156
100	144,000	0.223
250	360,000	0.557
500	720,000	1.11
1000	1,440,000	2.23

\* Appropriation permits are required from the DNR if water withdrawals exceed 10,000 gallons per day or 1 million gallons per year. Continuously pumping 1.9 gallons per minute for one year exceeds the 1 million gallons per year limit. Continuously pumping 6.9 gallons per minute for one day exceeds the 10,000 gallon per day limit.

\*\* Special construction is required for any flowing well or boring. Wells or borings which flow in excess of 70 gallons per minute, have pressures that exceed 10 psi, or where the well or boring is located in a flowing well or boring construction area must be double cased and cement grouted.

## CONVERSION FACTORS/WATER CALCULATIONS

- 1 acre (area) = 43,560 square feet
- 1 acre foot (volume) = 43,560 cubic feet
- 1 atmosphere (pressure) = 3.94 feet of water or 29.92 inches of mercury
  
- 1 centimeter (length) = 0.3937 inches
- 1 cubic centimeter (volume) = 0.06102 cubic inches or 0.033814 ounces
- 1 cubic foot of water (volume) = 7.481 gallons and weighs 62.316 pounds
- 1 cubic foot per second (cfs) (flow) = 450 gallons per minute (g.p.m.)
- 1 cubic foot per minute (flow = 7.481 g.p.m.)
- 1 cubic inch (volume) = 16.387 cubic centimeters
- 1 cubic yard (y<sup>3</sup>) (volume) = 27 cubic feet (ft<sup>3</sup>) = 202 gallons
  
- 1 foot (length) = 30.48 centimeters
- 1 foot of water (pressure) = 0.4335 pounds per square inch (psi)
- 1 foot per second (flow) = 0.68182 miles per hour
  
- 1 gallon (volume) = 0.1337 cubic feet or 128 fluid ounces
- 1 gallon of water weighs 8.3304 pounds
- 1 million gallons per day (flow) = 1.55 cubic feet per second or 694 g.p.m.
- 1 gallon per minute (flow) = 0.1337 cubic feet per minute (cfm)
- 1 grain per gallon (concentration) = 17.1488 parts per million (ppm)
- 1 gram (weight) = 15.432 grains or 0.03527 ounces
  
- 1 inch (length) = 2.540 centimeters
  
- 1 kilogram (weight) = 1000 grams or 2.2046 pounds
- 1 kilometer (length) = 3,280.8 feet or 0.62137 mile
  
- 1 liter (volume) = 0.001 cubic meter, 0.2642 gallon, or 1.057 quarts
  
- 1 meter (length) = 100 centimeters or 3.281 feet.
- 1 microgram per liter (µg/L) = 1 part per billion (ppb) (approximately)
- 1 micron (length) = 0.001 millimeter
- 1 mile (length) = 5,280 feet or 1.609 kilometers
- 1 mile per hour (flow) = 1.467 feet per second or 88 feet per minute
- 1 milligram per liter (mg/L) (concentration) = (approximately) 1 ppm
  
- 1 ounce (fluid) (volume) = 1.805 cubic inches
  
- 1 ppm (concentration) = 8.34 pounds per million gallons (of water)
- 1 percent (concentration) = 10,000 ppm
- 1 pound (weight) = 16 ounces or 0.4536 kilogram
- 1 pound per square inch (psi) (pressure) = 2.3066 feet of water or 27.68 inches of water
  
- 1 quart (volume) = 57.75 cubic inches or 0.0334 cubic foot

## CONVERSION FACTORS

### LENGTH

UNIT	EQUIVALENT						
	Centimeters	Inches	Feet	Yards	Meters	Kilometers	Miles
1 Centimeter =	One	.3937	.0328	.01093	.01	.00001	.00000621
1 Inch =	2.54	One	.08333	.0278	.02540	.0000254	.0000158
1 Foot =	30.48	12	One	.33333	.30480	.000305	.000189
1 Yard =	91.44	36	3	One	.91440	.000915	.000568
1 Meter =	100	39.37	3.2808	1.0936	One	.001	.000621
1 Kilometer =	100,000	39,370	3280.8	1093.6	1000	One	.62137
1 Mile =	160,935	63,360	5280	1760	1609.3	1.6093	One

### AREA

UNIT	EQUIVALENT						
	Square Centimeters	Square Inches	Square Feet	Square Yards	Square Meters	Acres	Square Miles
1 Sq. Centimeter =	One	.155	.001076	.0001196	.0001	---	---
1 Sq. Inch =	6.452	One	.00694	.0007716	.0006452	---	---
1 Sq. Foot =	929	144	One	.1111	.0929	.00002296	---
1 Sq. Yard =	8361	1296	9	One	.8361	.0002066	---
1 Sq. Meter =	10,000	1550	10.76	1.196	One	.0002471	---
1 Arce	40,465,284	6,272,640	43,560	4840	4047	One	.001563
1 Sq. Mile =	---	---	27,878,400	3,097,600	2,589,998	640	One

### VOLUME

UNIT	EQUIVALENT						
	Cubic Centimeters	Cubic Inches	Liters	U.S. Gallons	Cubic Feet	Cubic Yards	Cubic Meters
1 Cu. Centimeter =	One	.06102	.001	.0002642	.00003531	.000001308	.000001
1 Cu. Inch =	16.39	One	.016387	.004329	.0005787	.00002143	.00001639
1 Liter =	1000	61.0234	One	.26417	.03531	.001308	.001
1 U.S. Gallon =	3785.4	231	3.7854	One	.13368	.00495	.003785
1 Cubic Foot =	28,317	1728	28.317	7.4805	One	.03704	.02832
1 Cubic Yard =	764,560	46,656	764.56	201.974	27	One	.76456
1 Cubic Meter =	1,000,000	61,023	1000	264.17	35.3145	1.30794	One



**FLOW**

UNIT	EQUIVALENT				
	U.S. Gallon per Day	Cubic Feet per Day	U.S. Gallon per Minute	Acre Feet per Day	Cubic Feet per Second
1 U.S. Gallon per Day =	One	.1337	.0006944	.000003069	.000001548
1 Cubic Foot per Day =	7.4805	One	.005195	.00002296	.00001157
1 U.S. Gallon per Minute =	1440	192.50	One	.00442	.00223
1 Acre Foot per Day =	325,850	43,560	226.28	One	.5042
1 Cubic Foot per Second =	646,323	86,400	448.83	1.9935	One

**WEIGHT**

UNIT	EQUIVALENT				
	Grams	Avoirdupois Ounces	Avoirdupois Pounds	Kilograms	Tons (Short)
1 Gram =	One	0.3527	0.02205	.001	.000001102
1 Ounce (Avoirdupois) =	28.3495	One	.06250	.02835	.00003125
1 Pound (Avoirdupois) =	453.5924	16	One	.45359	.0005
1 Kilogram =	1000	35.2740	2.2046	One	.001102
1 Ton (Short)	907,184.8	32,000	2000	907.1846	One

## CALCULATING VOLUMES AND AREAS

Circumference of circle =  $3.1416 \times \text{diameter} = 6.2832 \times \text{radius}$

Area of circle =  $3.1416 \times (\text{radius})^2 = 0.7854 \times (\text{diameter})^2$

Volume of cylinder or pipe =  $0.7854 \times \text{height} \times (\text{diameter})^2$

Area of sphere =  $3.1416 \times (\text{diameter})^2$

Volume of sphere =  $0.5236 \times (\text{diameter})^3$

Area of triangle =  $0.5 \times \text{base} \times \text{height}$

Area of square or rectangle =  $\text{base} \times \text{height}$

Volume of cube or rectangular solid (parallelepiped) =  $\text{base} \times \text{height} \times \text{length}$

Volume of pyramid =  $\text{area of base} \times \frac{1}{3} \text{ height}$

Volume of cone =  $0.2618 \times (\text{diameter of base})^2 \times \text{height}$

## Property Location

The following illustration explains how to provide a well's location using the United States Land Office Grid System Coordinates.

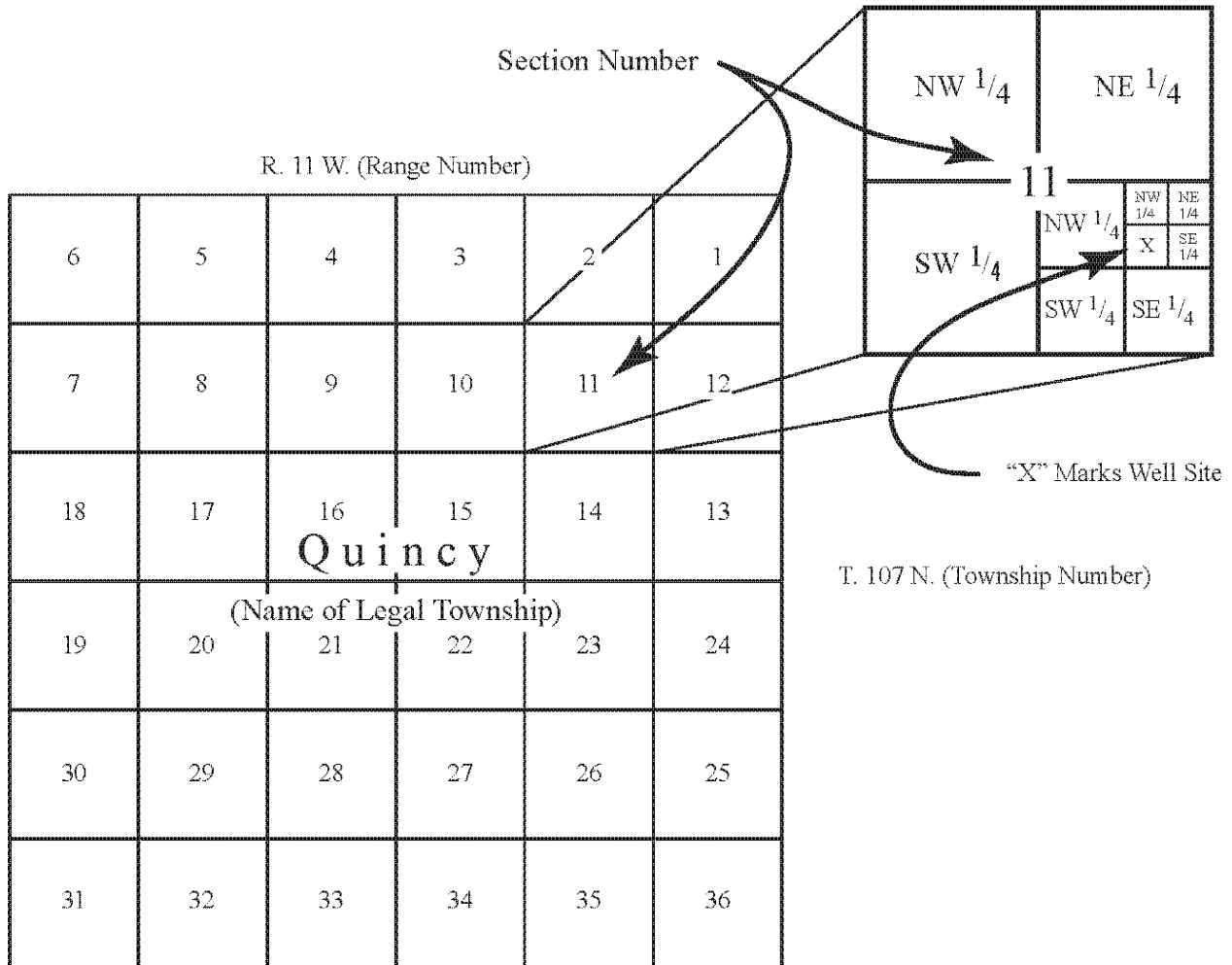

- Mark the position of the well on a map which uses the United States Land Office Grid System, such as a county highway map, USGS topographic map, or plat map.
- Determine the Township Number, the Range Number, and the Section Number in the legal township where the well is located.  
 Example:            T.107.N, R.11 W., Sec. 11
- Divide the Section into quarters and note in which Quarter Section the well is located.  
 Example:            SE 1/4
- Next, divide the Quarter Section into quarters and note the Quarter-Quarter Section.  
 Example:            NE 1/4
- Finally, divide the Quarter-Quarter Section into quarters and note the Quarter-Quarter-Quarter Section.  
 Example:            SW 1/4
- Now, write the well location from the smallest land subdivision to the largest.  
 Example:            SW 1/4 of NE 1/4 of SE 1/4, Sec. 11, T.107 N., R. 11 W.
- THE WELL IS NOW LOCATED TO THE NEAREST TEN ACRES.

## Property Location

A well's location can be determined to three quartiles (10 acres) by measuring (or estimating) the distance to the well from the nearest corner of the section. Distances below are given in feet.

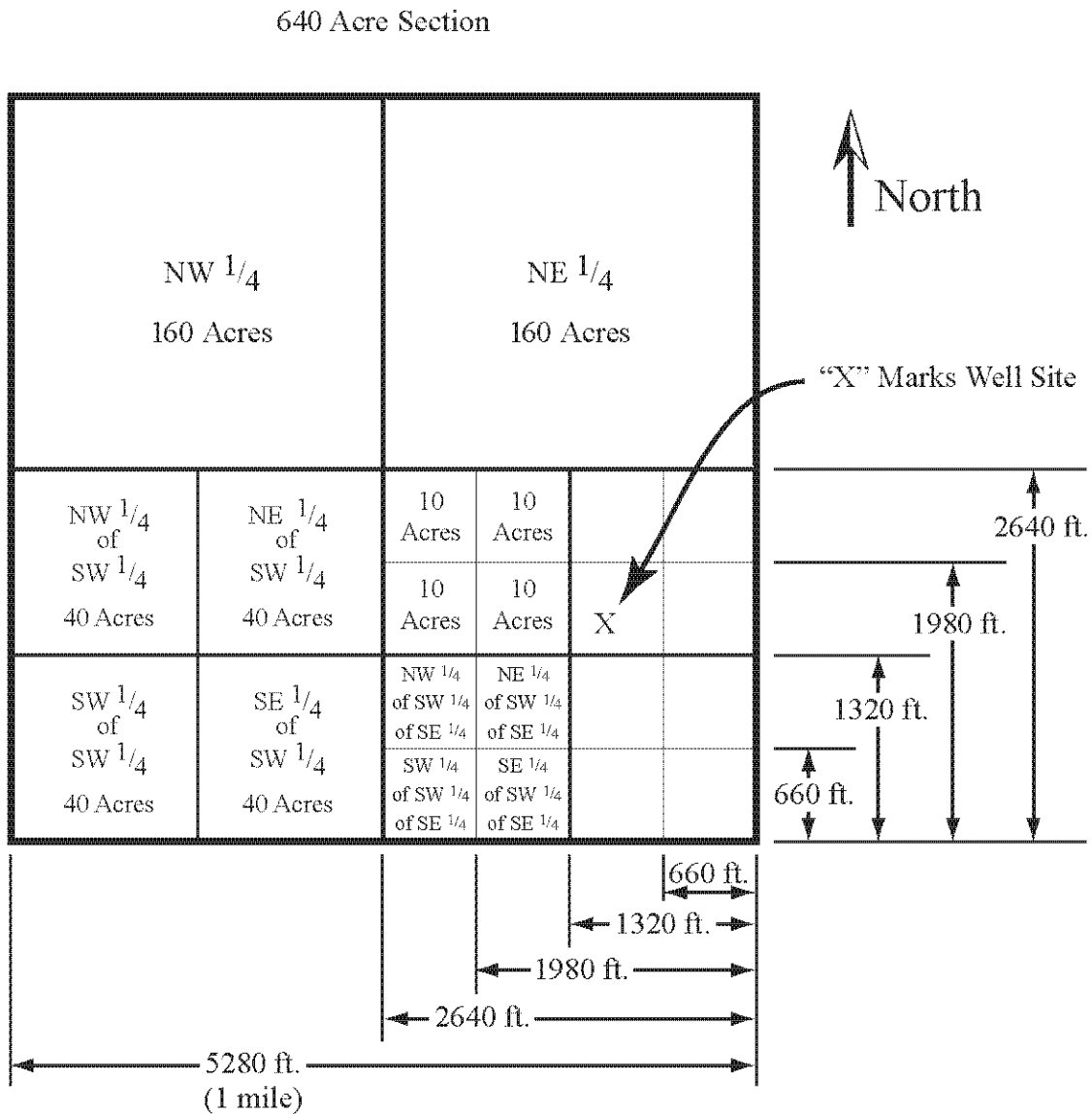

Using the example shown on the preceding page, this well is located between 1320 and 1980 feet north of the south section line and between 660 and 1320 feet west of the east section line. The well is in the SW 1/4 of the NE 1/4 of the SE 1/4 of the section.

## **MINNESOTA GROUNDWATER**

Groundwater is an important resource for Minnesota. Approximately three of every four Minnesotans use groundwater as a high quality source of drinking water. Groundwater is also used for other purposes including irrigation, industrial and commercial purposes, and heating and cooling. Groundwater quantity and quality are both dependent on geology. Soils, unconsolidated materials, and bedrock store groundwater, affect how much groundwater may be produced, influence how susceptible groundwater is to contamination, and affect the dissolved chemicals in the water. Some unconsolidated deposits and bedrock types readily store and transmit water (aquifers) while others do not (confining layers). The sequence of geologic materials beneath any part of Minnesota affects the amount of groundwater that can be present and hence affects the depths and yields of wells. Groundwater quality and quantity may be correlated with regional geologic conditions; however, wells may exhibit yields and quality considerably different from those expected on the basis of regional estimates. Local geologic conditions may even be so variable that the depths of wells within a single tract of land will be quite different.

Information about the geology and hydrogeology of the state may be obtained from well records, geologic maps, and hydrologic atlases available from the Minnesota Geological Survey, 2642 University Avenue West, St. Paul, Minnesota 55114-1057, 612-627-4780. The United States Geological Survey, Water Resources Division, 2280 Woodale Drive, Moundsview, Minnesota, 612-783-3100 also publishes reports and hydrologic atlases. Water well records are available online at [www.health.state.mn.us/divs/eh/cwi](http://www.health.state.mn.us/divs/eh/cwi).

### **GROUNDWATER**

Voids or pore spaces can occur between soil particles or rock fragments. The spaces can be large, such as the space between cobbles or gravel, or small such as the space between fine sand grains or even clay particles. Cracks or cavities in otherwise solid bedrock, such as granite or basalt, can also store water. If the spaces between the soil or rock particles, or the cracks and crevices, are connected to each other, rainfall or snow melt can infiltrate downward until the water reaches the water table. The water table is a surface beneath which all the pores and openings are filled with water.

### **AQUIFERS**

Earth materials that readily store and transmit water are called aquifers. Because groundwater occupies the pore spaces and cracks in soil, unconsolidated materials, or bedrock, the ability of an aquifer to yield water depends on (1) the percentage of the aquifer that is storage space, (2) the size of these storage spaces, (3) the degree to which they are interconnected, and (4) the extent and thickness of the aquifer. The larger the proportion of storage spaces and more uniform their distribution, the greater will be the capacity for an aquifer to yield water. A well-sorted, coarse-grained sand or sandstone has much more interconnected pore space than clay or shale and will yield water to pumping, while the clay or shale will exhibit little or no yield. Hard, dense bedrock, such as granite, may yield water from cracks or cavities, but usually at much lower rates because cracks normally have much less storage space than do voids between rock fragments. Sand, gravel, sandstone, limestone, and weathered or fractured rock are often aquifers. Clay, glacial till or "drift," shale, and unweathered igneous or metamorphic rocks are usually not aquifers and are referred to as confining layers.

## GROUNDWATER MOVEMENT

Gravity is the force which causes water to soak into porous soil, sediment and bedrock and to move laterally and vertically until it can escape from the strata which contain it. Places where water enters an aquifer are called recharge areas, and places where it leaves the ground are called discharge areas. Springs and seeps mark specific discharge points, but groundwater also discharges over larger areas, such as lake bottoms or along rivers. This explains why some lakes do not totally dry up and why some rivers continue to flow even during periods of prolonged drought. In places, groundwater moves laterally away from recharge areas but cannot discharge because gravity takes it under bodies of impermeable earth materials called confining layers. When wells are drilled through the confining layers, the groundwater will try to discharge from the well under what are called artesian conditions. The greater the water pressure or “head” within the aquifer, the greater will be the ability of the groundwater to rise against gravity. It can even reach the surface of the land and flow under what are called flowing artesian conditions.

The rate at which groundwater moves depends on combinations of a wide variety of geologic and hydrologic factors. Groundwater generally moves inches or feet per year, but may move miles per day in near-surface limestone aquifers that are honeycombed with caves. Typical groundwater movement in sand is 10 to 300 feet per year. Normally, the deeper below the land surface an aquifer occurs, the slower the groundwater moves within it and the longer infiltrating water takes to recharge it.

## MINNESOTA'S AQUIFERS

The two major categories of aquifers are unconsolidated deposits and bedrock. Most of Minnesota's bedrock is covered by a mantle of unconsolidated glacial deposits which range from a few feet, to more than 800 feet in thickness. Sand and gravel were sorted and redeposited by glacial meltwater over the bedrock surface, and some of these deposits can be observed at the land surface. However, some sand and gravel layers were covered by succeeding ice advances and were buried beneath clay or unsorted rock debris called till. Thick sequences of glacial deposits can contain several buried sand and gravel aquifers separated by confining layers of clay or till. The distribution of buried glacial aquifers is very difficult to determine without detailed investigation. Glacial aquifers that are only partially saturated or whose water levels fluctuate with atmospheric pressure are called unconfined, or “water-table,” aquifers. Bodies of sand and gravel that are covered by confining layers (clay, till) are generally buried artesian aquifers. Many wells, particularly in the western and central parts of Minnesota, obtain groundwater from glacial aquifers.

Bedrock aquifers include all types of bedrock that yield water to pumping. The bedrock over much of Minnesota yields very little water. Several exceptions occur in parts of the iron range, east-central Minnesota, and particularly in the southeastern part of the state. Bedrock aquifers may be under water-table or artesian conditions, depending on local geologic conditions.

## REGIONAL HYDROGEOLOGY

Groundwater is not uniformly distributed throughout Minnesota because of the wide variety of geologic conditions. Aquifers vary in composition, thickness, and distribution due to the geologic history of the area.

The following section discusses the general geologic and hydrologic conditions found in Minnesota. For discussion purposes, the state has been divided into six regions with similar geologic and hydrologic characteristics. A map found at the end of this section illustrates the regional hydrogeology.

### SOUTHEASTERN MINNESOTA – AREA OF GREATEST BEDROCK-AQUIFER YIELD

Southeastern Minnesota contains the state's largest reserves of high-quality groundwater. Sandstone, limestone, and dolomite bedrock formations, which have a large proportion of storage space, yield large amounts of groundwater. Some wells may yield more than 2,000 gallons per minute. These bedrock strata were deposited in ancient seas which once covered much of the upper Midwest, and thus these rock types also occur in Iowa and Wisconsin. Sandwiched between these bedrock aquifers are confining layers of shale and siltstone which do not readily yield water. As a result, the sequence of bedrock strata in southeastern Minnesota may be divided into aquifer systems, each of which is separated from the others by bedrock confining layers. A geologic column is included at the end of this section.

The geologic conditions in southeastern Minnesota which enable bedrock to store and transmit large volumes of groundwater also permit rapid contamination by unwise land-use and waste-disposal practices. Limestone and dolomite formations are especially sensitive because in some places they are honeycombed with caves and solution cavities of all shapes and sizes. This condition, termed "karst," permits the rapid infiltration of surface water and contaminants where limestone and dolomite formations occur at or near the land surface. The eastern half of the area generally has less than 100 feet of glacial deposits covering karst bedrock, and nitrate levels are frequently a concern in these limestone and dolomite aquifers. Where limestone or dolomite aquifers are particularly susceptible to contamination, use of the dolomite or limestone for potable supply is prohibited. If a lower aquifer is used, the casing must be cement grouted through the karst formation. This construction procedure prevents undesired water from directly entering the well along the bore hole. The presence of caves or other solution cavities may require large amounts of cement to seal the casing, thereby greatly increasing the cost of new well construction. Large amounts of cement may also be required for proper sealing of unsealed (abandoned) wells in which karst formations were left as an open bore hole.

Glacial deposits in southeastern Minnesota are used locally for domestic supplies and for a limited amount of high-capacity pumpage. Sand-plain aquifers north, east, and southeast of the St. Paul-Minneapolis area provide locally large supplies of groundwater but are particularly sensitive to agricultural (row crop fertilizer and pesticide use) and urban (sewage) contamination. The thickness of glacial deposits increases in a westward direction across the area and commonly exceeds 300 feet along the western margin. Near-surface sand aquifers are most abundant in the north and exhibit a high-yield potential. Elsewhere, buried sand and gravel aquifers generally have a much lower potential for groundwater yield.

### WESTERN MINNESOTA – AREA OF WIDELY DISTRIBUTED GLACIAL AQUIFERS

A diversity in the types of glacial deposits and in bedrock conditions occurs throughout this area. Aquifers capable of high yields are found in some portions of the central or northern portions of the region in glacial sands and gravels within 200 feet of the land surface. Most sand and gravel deposits, however, can provide only enough water for domestic wells. These aquifers occur at variable depths sandwiched between layers of glacial clay or till. The thickness of glacial deposits in this region ranges from less than 100 feet to more than 800 feet in the south. The thickness is not well known in the north, but is believed to be at least several hundred feet. The sporadic distribution of buried sand and gravel aquifers throughout this entire area makes it difficult to predict the location, size, and depth of aquifers and to assess groundwater reserves. The generally low water yield, higher sulfate concentrations, and elevated nitrate have led to rural water systems serving large areas of the southwestern portion of the district. Arsenic may exceed drinking water standards, particularly in buried glacial aquifers in the west central portion of the region.

The known bedrock types are primarily hard, dense, crystalline rocks, such as granite, or a variety of dense metamorphic rocks, none of which usually yields more than a gallon per minute. However, some Cretaceous sandstone is present locally and may provide somewhat higher yields. This sandstone was deposited in a shallow sea that once covered much of western Minnesota, but glacial erosion has left only widely scattered patches buried by hundreds of feet of clay, sand, and gravel. Cretaceous deposits may be too fine to produce sand-free water, and may have elevated sulfate and total dissolved solids. The upper part of some types of hard, dense bedrock was weathered to a clay-rich residue called regolith, prior to glaciation and burial by glacial deposits. The distribution of regolith is variable and in some places it will yield enough water for domestic wells. Wells in the regolith may produce water with suspended clay or silt, which gives the water a cloudy appearance and may eventually plug water conditioning equipment.

#### CENTRAL MINNESOTA – AREA OF GREATEST YIELD POTENTIAL FROM GLACIAL AQUIFERS

Deposits of sand and gravel occur at or near the land surface in many parts of central Minnesota and supply large volumes of groundwater. These “sand plain” aquifers have been extensively developed for irrigation and municipal use. Some buried sand and gravel aquifers also are capable of supplying high-capacity wells. However, there are parts of this region where neither type of glacial aquifer occurs, and not enough groundwater may exist in the glacial deposits to supply even a domestic well. Wells must then draw water from the bedrock, which exhibits low yields.

Bedrock commonly occurs at or near the land surface in the eastern third of this area, but elsewhere is covered by glacial deposits which may exceed 500 feet in thickness. Hard, dense granite and metamorphic rocks which often yield less than a gallon per minute are used where glacial aquifers are absent. Bedrock wells may have to be drilled hundreds of feet before encountering cracks which provide enough water. Although bedrock yields are small, a high artesian pressure is usually present, which raises the water level in the well during periods of non-pumping and thus permits the well itself to serve as a reservoir.

Weathered bedrock occurs in remnant patches particularly in the western half of this area, and may yield small amounts of groundwater. However, as with regolith materials in other parts of western Minnesota, small amounts of fine material may be pumped with the water and lead to plumbing difficulties.

#### SOUTHWESTERN MINNESOTA – AREAS OF LOW-YIELD POTENTIAL

The Sioux Quartzite, an extremely hard, dense metamorphic rock, is covered by only a thin mantle of glacial deposits. This quartzite is exposed throughout the western area and in parts of the eastern area. The thin glacial deposits contain only small, patchy occurrences of low-yielding sand and gravel aquifers. Wells may have to be drilled several hundred feet into the quartzite, and then may still only yield small quantities of water.

#### RED RIVER VALLEY

The extremely flat land surface of this region was once the bed of glacial Lake Agassiz, which covered a large part of Minnesota, North Dakota, and southern Canada at the end of the last glacial period. The lake deposits are mostly soft, sticky clay which produce little or no water. However, very localized deposits of sand and gravel, often formed as beach ridge deposits, occur in these lake clays and can produce large amounts of groundwater. These aquifers are pumped heavily for agricultural irrigation, and municipal or industrial supply. The glacial deposits that underlie the Lake Agassiz sediments contain irregularly distributed layers of sand and gravel that will provide for domestic wells, but rarely for large scale, high-capacity pumpage. Deeper aquifers may produce water with high dissolved solids. Where glacial aquifers do not exist, water must be transported in, because the bedrock either does not yield a sufficient supply or yields water that is saline.



The bedrock which occurs 300 to 400 feet below the surface throughout the southern 2/3 of the Red River Valley is hard and dense and is rarely used as an aquifer. Sandstone, limestone, and dolomite occur less than 200 feet below the surface in the northern third of the valley, but yield low-quality saline groundwater and are not used as aquifers.

Flowing artesian conditions are frequently encountered in glacial aquifers, particularly along the eastern margin of the area.

#### NORTHEASTERN MINNESOTA

Bedrock is exposed or occurs at shallow depths below the land surface throughout much of this region. Although the surface topography is marked by thousands of lakes and wetlands, most of the bedrock does not readily yield groundwater. Exceptions are some of the bedrock associated with the iron ranges, such as the Biwabik Iron formation, which yield large volumes of groundwater for municipal and mining use. Also, a well-cemented sandstone in the extreme southern part of the area will commonly provide municipal, as well as a domestic supply. Generally, well construction in the hard, dense bedrock types of northeastern Minnesota is difficult, and successful completion of a well cannot be guaranteed. Hydrofracturing of bedrock is sometimes successful in increasing yields. Some bedrock wells near Lake Superior may have high salinity, boron, and fluoride.

Thick accumulations of glacial deposits occur only in a narrow band extending about 30 miles southwest from Lake Superior. Elsewhere, the depth to bedrock is typically less than 100 feet. Near-surface sand and gravel deposits occur locally and supply domestic needs but have not been extensively developed for high-capacity pumpage. Buried sand and gravel deposits are used where present, but generally have limited distribution and exhibit variable yield. Where glacial aquifers are absent or very thin, some older wells were finished so as to draw water that collects at the boundary between the glacial materials and the bedrock.

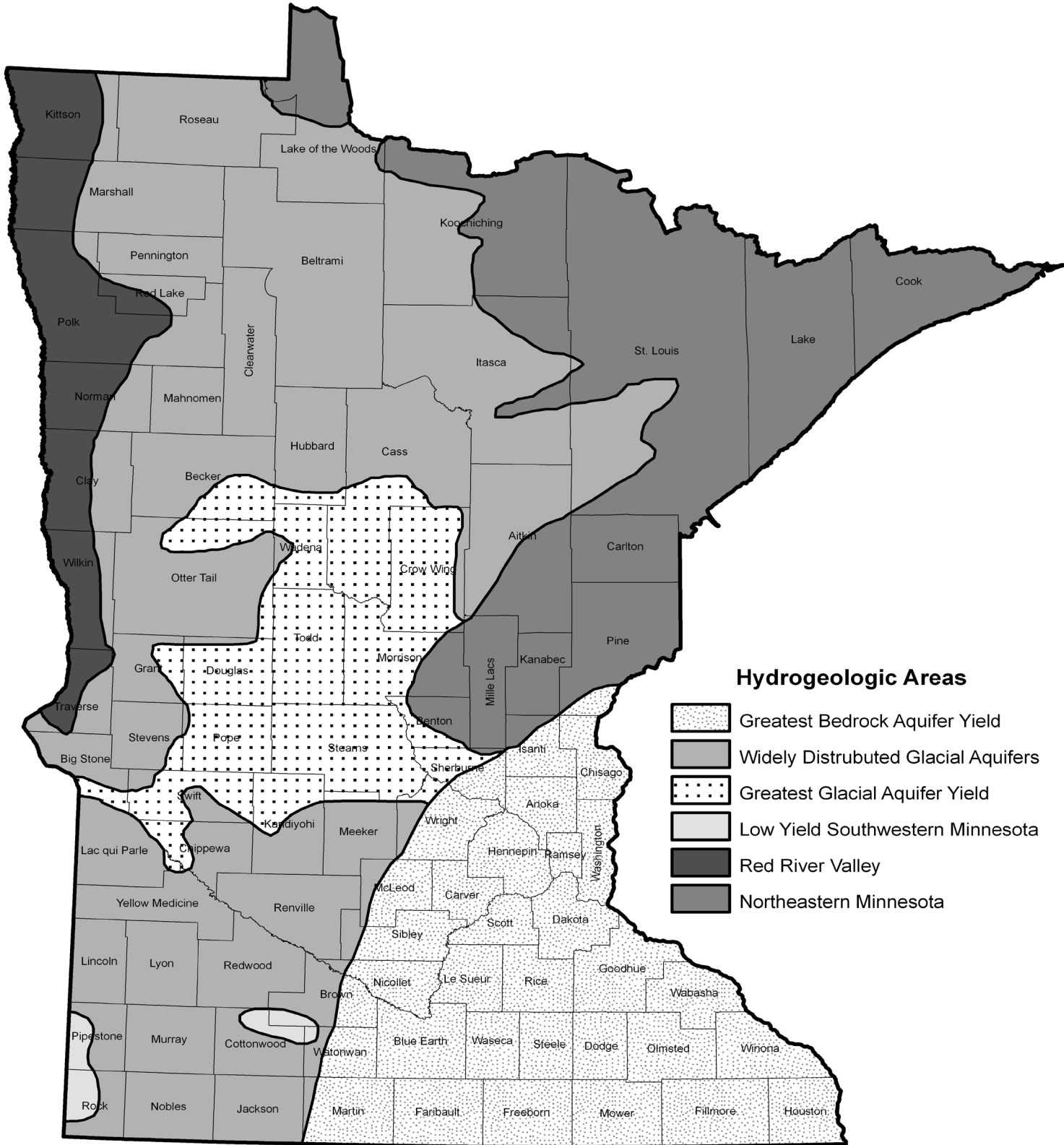

## AQUIFERS AND CONFINING LAYERS IN SOUTHEASTERN MINNESOTA

EON AND ERA	SYSTEM	GEOLOGIC UNIT	GRAPHIC COLUMN	APPROX. MAX. THICK.	HYDROGEOLOGIC UNIT			
CENOZOIC	QUATERNARY	UNDIFFERENTIATED DRIFT		800 feet	UNCONSOLIDATED DEPOSITS			
		PALEOZOIC						
DEVONIAN	CEDAR VALLEY FORMATION	305 feet				UPPER CARBONATE AQUIFER		
	MAQUOKETA FORMATION	70 feet						
DUBUQUE FORMATION	35 feet							
ORDOVICIAN	GALENA GROUP	230 feet						
	DECORAH SHALE	95 feet					DECORAH CONFINING LAYER	
	PLATTEVILLE FORMATION	35 feet				PLATTEVILLE AQUIFER		
GLENWOOD FORMATION	18 feet	GLENWOOD CONFINING LAYER						
ST. PETER SANDSTONE	155 feet	ST. PETER AQUIFER						
	BASAL ST. PETER CONFINING LAYER (mainly occurs in Twin Cities area)							
PRAIRIE DU CHIEN GROUP	360 feet	PRAIRIE DU CHIEN-JORDAN AQUIFER						
	JORDAN SANDSTONE					110 feet		
ST. LAWRENCE FORMATION	90 feet	ST. LAWRENCE CONFINING LAYER						
CAMBRIAN	FRANCONIA FORMATION	190 feet				FRANCONIA-IRONTON-GALESVILLE AQUIFER		
	IRONTON SANDSTONE	45 feet						
	GALESVILLE SANDSTONE	95 feet						
	EAU CLAIRE FORMATION	200 feet				EAU CLAIRE CONFINING LAYER		
	MT. SIMON SANDSTONE	600 feet				MT. SIMON-HINCKLEY AQUIFER		
PROTEROZOIC	PC	HINCKLEY SANDSTONE					5000+ feet	CONFINING LAYER
		SEDIMENTARY ROCKS						
		CRYSTALLINE RX						

## WELL DISCLOSURE

### *What is well disclosure?*

Well disclosure is the process by which the seller of real property (real estate) provides information to the buyer and the state about the location and status of all wells on the property. This process is required by state law, Minnesota Statutes, section 103I.235. The law applies to all types of wells, including drilled, dug, driven, and drive-point, and to monitoring, dewatering and water-supply (drinking water, irrigation, livestock, commercial or industrial processing, heating or cooling) wells.

The primary purpose of well disclosure is to identify abandoned or “not in use” wells and have them sealed or placed back into service.

Well disclosure does not require water testing or inspection of in use wells for code compliance at the time of property transfer.

### *Why is well disclosure important?*

Well disclosure gives valuable information to the property buyer about the location and status of wells – including unused or “abandoned” wells – on property that is sold or transferred. Unused, unsealed wells provide a pathway through which contaminants may move to the groundwater and contaminate nearby wells. Groundwater provides drinking water to three out of four residents in Minnesota. Sealing unused wells is one important way to protect this valuable resource.

### *When and how are wells disclosed?*

Well disclosure is a two-step process involving a disclosure statement and a disclosure certificate. **Before signing an agreement to sell or transfer real property** the seller must disclose in writing to the buyer information about the status and location of all known wells on the property. This information must be provided to the buyer, but is not required to be provided to the county or the state, and is not required to be on a specified form. This requirement also applies to contract-for-deed sales. The WELL DISCLOSURE STATEMENT must include:

- A. The legal description and county;
- B. A map showing the location of each well; and
- C. Whether each well is in use, not in use, or sealed.

A well is “in use” if the well is functioning for some purpose. The purpose may be seasonal, such as irrigation. A well is “not in use” if the well is not functioning or is not capable of functioning, such as when the well pump on the well is disconnected, or when the well is no longer connected to a power supply. A well is “sealed” if the well has been filled with an approved sealing material by a licensed well contractor or a licensed well sealing contractor and the MDH has received a Well and Boring Sealing Record.

**At the time of closing of the sale**, the information on the well disclosure statement, along with the name and mailing address of the buyer, and the quarter, section, township, and range OR lot, block, and addition name of the property must be provided on A WELL DISCLOSURE CERTIFICATE. This is an MDH form available from the MDH by mail, on the MDH website, or is also available from many real estate agents and county recorders. The seller or person authorized to act on behalf of the seller signs the certificate. In the absence of the seller's signature, the certificate may be prepared and signed by the buyer or person authorized to act on behalf of the buyer.

In the case of a contract-for-deed sale, the certificate is prepared and signed by the seller (grantor) or person authorized to act on behalf of the seller, when the contract is recorded at the beginning of the contract. When the contract is recorded at the fulfillment of the contract, the certificate is prepared and signed by the buyer (grantee) or person authorized to act on behalf of the buyer. The MDH can provide information concerning the disclosure of well(s) at the time of the sale of condominiums or state-leased land.

When the deed is recorded with the county recorder or registrar of titles, the buyer must provide the Well Disclosure Certificate along with a \$45 fee.

*Is a well disclosure certificate needed if one was filed for a previous transfer of the property?*

A new well disclosure certificate is not required if the number and status of the wells has not changed since the last well disclosure certificate was filed, and if the following statement is included on the deed to comply with the certification requirement: "I am familiar with the property described in this instrument and I certify that the status and number of wells on the described real property have not changed since the last previously filed well disclosure certificate." This statement must be followed by the signature of the seller or buyer, or person authorized to act on behalf of the seller or buyer.

*What if there are no wells on the property?*

A well disclosure **statement is required** to be provided to the buyer indicating that the seller does not know of any wells on the property. A well disclosure **certificate is not required** to be provided if the seller does not know of any wells on the property and the deed or other instrument of conveyance contains the words: "The seller certifies that the seller does not know of any wells on the described real property." For a fulfillment of the contract-for-deed sale "grantee" is used instead of "seller" and it is followed by the signature of the grantee. This statement must be followed by the signature of the seller or buyer, or person authorized to act on behalf of the seller or buyer.

*Is the seller liable for false disclosure?*

A seller may be liable to the buyer for reasonable attorney fees and costs related to sealing of the well if the seller knew or had reason to know but failed to disclose the existence or known status of a well at the time of sale. The buyer has six years after the purchase of the property to bring action against the seller (Minnesota Statutes, section 103I.235). Contracts or other legal conditions may affect this action. The provision in law establishes a civil process (through the courts) and not an administrative or regulatory process (through the MDH). Disputes that cannot be resolved by the buyer, seller, or other parties are sometimes resolved through arbitration, conciliation court, or other courts.

*How do I know if there is a well on the property?*

Occupied properties not served by a public water system typically have one or more wells. Homes, businesses, or other occupied properties in use prior to the installation of city water services usually have one or more wells, which are often unused and unsealed. The city usually has information about when a home was built, when city water was installed, and may have information about the well itself. Properties that had a need or use for water such as irrigated fields often had wells. In rural areas, farmsteads may have additional wells located in, or adjacent to, outbuildings or livestock areas. Lake cabins usually have one or more wells as a source of water. Lake water systems, rain water systems, hauled-water cisterns, and shared wells exist, but are rare.

Determining whether a property has one or more wells usually starts with a discussion with the property owner and a search of the property. In some cases, other persons need to be contacted, records need to be searched, and more extensive investigation needs to be done. A good quality metal detector (not one used for finding lost coins or jewelry) can be invaluable for finding buried steel-cased wells. For further information, see the *Finding Lost Wells – Searching for Wells on a Property* discussion.

*What if a well is not in use?*

If a well is not in use, the property owner has three options:

- A. the well can be put back into use;
- B. the well can be sealed by a licensed well contractor, or a licensed well sealing contractor; or
- C. the property owner can apply for a maintenance permit.

If one of these steps has not been taken at the time of property transfer, it will be the responsibility of the buyer to choose an option and follow through with it.

*What is well sealing and what if the well appears to be sealed?*

Well sealing is the process of permanently and completely filling a well with an approved grout. State law requires that a well must be sealed by a licensed well contractor or a licensed well sealing contractor. The sealing process starts with removal of the pump, drop pipe, suction pipe, pump rods or other pipes inside the well casing (the outer well casing is usually not removed). Debris, sand, unapproved grout, and any materials or obstructions in the well must be removed. A grout or “tremie” pipe is then installed to the bottom of the well and the grout, usually consisting of neat-cement grout, cement-sand grout, or bentonite grout is pumped into the well. UngROUTED liner casings or casings through bedrock must be grouted in place, removed, or perforated before pumping the grout to ensure a proper sealing. The final step in sealing is sending a “Well and Boring Sealing Record” to the MDH and well owner.

If a well appears to be sealed, but a sealing record cannot be found, further investigation is needed. Neat - cement or bentonite grout in the top of the well may indicate that the well was sealed by a licensed well contractor. If concrete, mortar, or other grout materials is observed, it is unlikely that the well was sealed properly by a licensed contractor. Regardless, if a sealing record or other verified information cannot be found, the well is not considered to be properly sealed. Depending on the specific conditions, it may be necessary to drill into the well to determine the type of material filling the well and to ensure that the well was not simply plugged at the top. If the well was not properly sealed, it must be cleaned out and sealed.

For further information, see the comments in the well sealing section, Minnesota Rules, part 4725.3850.

*What is a maintenance permit?*

A maintenance permit allows an unused well to remain unsealed if it is properly maintained. The permit is not transferable and requires a yearly fee of \$175. The property owner does not have to apply for a maintenance permit if the well is put back into use or if the well is sealed by a licensed contractor or a licensed well sealing contractor. A maintenance permit will not be approved by the MDH if the well is contaminated; if the well is improperly sealed; or if the well is located, constructed, or maintained in a manner that is a safety or health hazard. Delegated well programs may have additional requirements for maintenance permits and should be contacted for additional requirements.



## Finding Lost Wells Searching For Wells on a Property

Minnesota Department of Health

Well Management Section  
625 North Robert Street, P.O. Box 64975  
St. Paul, Minnesota 55164-0975  
651-201-4600 or 800-383-9808  
[www.health.state.mn.us/divs/eh/wells](http://www.health.state.mn.us/divs/eh/wells)

Environmental Health Division

Unused wells are often visible as a 1¼ inch to 6-inch diameter steel pipe sticking above the ground, the floor of a basement or basement offset, or a well pit. However, older wells may have casing made of concrete, tile, rock, brick, or stone; and many newer wells are cased with plastic pipe. As discussed previously, some wells were originally buried, and if properties have been remodeled, wells may be built over or around, cut off, or buried. Wells have a life expectancy that can vary considerably. While some wells may last 100 or more years, a life of 25 to 50 years is more common. Properties with a long history may have more than one well. Farm properties are more likely to have multiple wells to serve barns, irrigation, and other purposes.

Well searches generally start with a visual inspection. The information listed under “Physical Evidence” may help find a well. People familiar with the property may be aware of the property’s history, and may be able to point to “lost” wells. State well records were not required before 1974. However, the Minnesota Geological Survey has collected historic well records where available. Counties, townships, or cities may have well information with building permit, sewer permit, or property files. In cases where the physical evidence, personal knowledge, or records are absent, some tools may be needed to locate wells.

### Individuals Familiar With Property

- Property owner.
- Relatives or acquaintances who may know about wells on the property.
- Previous property owners.
- Neighbors who might be familiar with property (**neighboring wells may also give a clue as to well location, depth, and construction**).
- Contractors (well drillers, pump installers, plumbers, remodelers) who have worked on property.
- Inspectors (well, plumbing, building, septic system, milk).
- Current or former employees, maintenance personnel.

### Physical Evidence

- Casing visible above ground, concrete slab, or through basement floor.
- Evidence of a well, such as circular ring in cement or patch in the floor.
- Basement offset (small room off of basement, often under steps).
- Glass block or patch in step or concrete (access for well below).
- Windmill (usually directly over well).
- Pit in yard or basement (may be covered with wood, concrete, or steel; well may be at the bottom of pit or the pit may be a dug well).
- Waterline (pipe) or patched hole through basement floor or basement wall.

### **Physical Evidence** (continued)

- Water system components (i.e., pressure tank, pump, or evidence of former components, like “shadow” lines on floor or wall).
- Electrical components (wiring through basement floor/wall, control box).
- Low spot in yard, circular depression (may be damp).
- Outbuildings (may be well house).
- Additions, false walls, paneling which may “hide” well.

### **Record Search**

- Owner’s records (i.e., bills, easements on deed) or information written on pressure tank, control box, or well room wall.
- “County Well Index” database – at Minnesota Geological Survey (612-627-4784), Minnesota Department of Health (MDH) Well Management Section, or local government agencies.
- Well Disclosure Certificates – at MDH Well Management Section (filed since November 1990). A Well Disclosure Certificate might have already been filed for the property. Visit the MDH Well Management Section, Well Disclosure Program Web site at: [www.health.state.mn.us/divs/eh/wells/disclosures](http://www.health.state.mn.us/divs/eh/wells/disclosures).
- Well and Boring Records and Well and Boring Sealing Records – at the MDH Well Management Section.
- City, Township, or County Officials – may have records of wells on a property, such as through building, water connection, or sewer permits.
- Municipal water department – may have record of when public water supply was provided to property. If home or facility predates this connection, the property likely has one or more wells.
- Sanborn Fire Insurance maps and Fire Underwriters Inspection Bureau (a.k.a. Fisher) maps (well information for commercial or industrial properties), available at Minnesota History Center and at University of Minnesota Wilson Library.
- Old photographs of the property.
- Aerial photographs of property (may show windmills, well houses) – available at local Soil and Water Conservation District office or at: [msrmaps.com](http://msrmaps.com).
- County plat books (Minnesota History Center, Soil and Water Conservation Districts, County Recorders/Auditors).
- Topographic maps – locations of buildings and roads.

### **Equipment and Tools for Well Contractors**

- Metal locators and magnetometers (i.e., fluxgate magnetic pipe locator or proton magnetometer).
- Tape measure or “snake” to follow pipes (i.e., sondes, pipe locators, or tracers).
- Ground-penetrating radar (outlining buried structures).
- Excavation equipment including shovels, hammers, chisels, backhoe.
- Small rotary hammer or corer, bits, extensions, vacuum.

Visit the MDH Well Management Section Web site at: [www.health.state.mn.us/divs/eh/wells](http://www.health.state.mn.us/divs/eh/wells).

To request this document in another format, call 651-201-4600. Deaf and hard-of-hearing: TTY 651-201-5797.



# GEOTHERMAL

## INTRODUCTION

Geothermal systems use the thermal energy stored in the earth's crust as a source of heat for heating, and as a heat sink for cooling. In the heating mode, geothermal heat exchangers remove heat stored in the earth and transfer the heat to another location, typically a residential, commercial, or other building. In the cooling mode, heat is removed from the building and transferred to the earth. Geothermal technology relies on the fact that the earth's temperature at depth remains relatively constant. In Minnesota this temperature ranges from about 40 degrees Fahrenheit in the north to 50 degrees Fahrenheit in the south at a depth of 50 feet throughout the year. Geothermal systems go by various names including geothermal heat pumps, ground-source heat pumps, vertical heat exchangers, earth-coupled heat exchangers, loops, groundwater thermal heat exchangers, and heat pumps. By whatever name, the basic technology remains the same.

Once installed, geothermal heat exchangers are able to comfortably heat and cool buildings at very low operating costs, requiring only a relatively small amount of electricity to operate. In addition, some systems are designed to provide hot water for domestic use.

## OPEN AND CLOSED LOOPS

There are two main types of geothermal heat exchangers used in Minnesota – open loop and closed loop.

In an open loop system, groundwater is pumped from a water-supply well to the heat exchanger, heat is transferred, and the water is then discharged to an injection well, onto the ground surface, into a shallow subsurface disposal system, or into surface water. In some cases, a portion of the water may be used for other purposes such as irrigation. The construction of an open loop system with discharge to a well is referred to in Minnesota statutes and rules as a “groundwater thermal exchange device.” These systems may include two wells – a supply well and an injection well, or two wells that seasonally alternate supply and injection; or a single well serving as both supply and injection, a so-called “standing column well.” A system that does not discharge to a well is sometimes referred to as “pump and dump.” Water demand requirements vary, but typical sized domestic pumps producing 10 to 15 gallons of water per minute are often adequate. A domestic system for both heating and cooling will typically require more than 1 million gallons of water per year.

In a closed loop system, a heat transfer fluid is circulated through piping that has been placed beneath the earth's surface, either horizontally in an excavation, vertically in a bore hole, or even sometimes in a surface water body. Water is not withdrawn from a closed system and is not necessary for it to function; however, systems installed below the water level provide much greater thermal efficiency. The amount of piping and heat transfer fluid required in a closed loop system is dependant on the heating and cooling demand of the building, the temperature of the earth, and the thermal conductivity of the formation it is placed in. Closed loop systems can be designed to meet a wide range of heating and cooling needs from single-family residences to large commercial buildings. A typical private residence may require four to eight vertical loops, each between 100 and 200 feet deep, while a large commercial building or school may require hundreds or even thousands of vertical loops. Loop depth is dependent on geology, system design, and cost, but is typically 50 to 250 feet deep. Loops may penetrate bedrock, but often are designed to terminate in glacial sediments.

## OPEN LOOP REQUIREMENTS

Construction of wells used for open loop systems, and permitting of groundwater thermal exchange devices is regulated under Minnesota Statutes, Chapter 103I, and Minnesota Rules, Chapter 4725. Withdrawal of water exceeding 1 million gallons per year or 10,000 gallons per day is regulated by the DNR. Minnesota Statutes, section 103G.271, administered by the DNR, restricts the amount of water used for once through systems (pump and dump) to no more than 5 million gallons of water per year. This

restriction limits the application of an open loop system to residential or smaller sized commercial buildings. However, this restriction does not apply to groundwater thermal exchange devices (injection wells) under permit from the MDH, which are instead limited to a maximum of 50 gallons per minute. Construction of supply and injection wells, and permitting of injection, are regulated under Minnesota Rules, Chapter 4725. Disposal to surface water or to subsurface trenches or drainfields may be regulated by the MPCA, some local governments, or the DNR.

- Only a Minnesota-licensed well contractor may install a groundwater thermal exchange device supply well and the injection well (if one is used).
- The permit requirements for an injection well system are contained in Minnesota Statutes, section 103I.621, and Minnesota Rules, part 4725.1831. A single permit includes both the withdrawal and injection wells. The permit fee is established in Minnesota Statutes, section 103I.208.
- A permit is not required for a system that does not discharge to an injection well; however, a construction notification must be submitted for a well constructed for a surface disposal system.
- An existing well may be used for supply or injection if it meets the standards of the rules.
- The wells must be constructed to the water-supply well standards of Minnesota Rules, Chapter 4725, including meeting the isolation distances from sources of contamination.

Problems that may affect open loops include insufficient water yield, freezing of discharged water in winter, plugging of injection wells or shallow subsurface disposal systems, cross-connections, leaching of metals or other chemicals from the system, and flooding or erosion from discharged water. Due to these issues, very few groundwater thermal exchange devices (injection wells) have been installed. A somewhat greater number of open loop, surface disposal systems has been installed.

#### CLOSED LOOP REQUIREMENTS

In Minnesota, closed loop systems that are placed in vertical bore holes are referred to as “vertical heat exchangers,” and are regulated under Minnesota Statutes, section 103I.641 and Minnesota Rules, part 4725.7050. The regulations allow only SDR 11, high density polyethylene pipe (HDPE), pressure rated to 160 pounds per square inch, to be placed in the bore holes. The piping must be pressure tested after installation in the bore hole, and must be grouted for the full depth of the bore hole with an approved grout. The grout serves to protect groundwater should there be a leak, and also is needed to provide a thermal connection between the piping and the bore hole wall. The heat transfer fluid must be only food-grade or USP-grade propylene glycol and water. The propylene glycol is a safe, low-toxicity anti-freeze, used to prevent the heat transfer fluid from freezing during the winter heating period.

Closed loop heat exchangers installed horizontally in the ground either in trenches, typically 6 to 10 feet deep, or coiled in pits (“slinky systems”) are not directly regulated by the MDH. The heat transfer fluid is usually a water and anti-freeze solution which often contains glycol, methanol, ethanol or some other chemicals. Some of these materials may be much more toxic than food-grade propylene glycol.

Closed loop heat exchangers must be set back, or “isolated,” from water-supply wells. The required isolation distance is based on the relative risk to the well. The vertical piping of a permitted vertical heat exchanger must be 35 feet from a water-supply well, and the horizontal piping must be 10 feet if approved materials are used. A horizontal, slinky, or other unregulated heat exchanger constructed with piping materials and heat transfer fluid that does not meet the rule standards must be 50 feet from a water-supply well. A 10-foot distance is required if the materials and heat transfer fluid (propylene glycol) comply with the rule standards.

Closed loop heat exchangers located on the bed of a public (surface) water such as a lake, are regulated by the DNR under Minnesota Rules, part 6115.0211. A permit is required. The rule requires that the heat transfer fluid used must not be detrimental to the environment should a release occur.

- A vertical heat exchanger must be installed by a Minnesota-licensed well contractor or vertical heat exchanger contractor.
- A permit is required to install a vertical heat exchanger. The permit includes all borings in a system, whether the system has one or one thousand borings (loops). The permit fee is established in Minnesota Statutes, section 103I.208.
- The MDH does not regulate the construction of horizontal closed loop systems, only the setback to water-supply wells.
- Vertical heat exchangers must comply with the setbacks to water-supply wells; buildings; and utilities including electric lines, gas pipes, and LP tanks. Vertical heat exchangers are not required to comply with the setbacks to sources of contamination, but it is recommended that the setbacks be followed whenever possible.
- The DLI, and the Minnesota Plumbing Board regulate plumbing through the Minnesota Plumbing Code, Minnesota Rules, Chapter 4715. The rule requires a 10-foot setback between a source of contamination and a water service line. The DLI requires this setback to be maintained between a water service line and closed loop piping containing a refrigerant or antifreeze, including propylene glycol. The DLI also regulates the HVAC system under the Minnesota Mechanical Code.

The first vertical heat exchanger permits were issued in 1984. Since 1984, over 2,000 permits have been issued. In recent years, the construction of vertical heat exchangers has rapidly expanded. In 2005 approximately 130 permits were issued, while in 2009 492 permits were issued.

Another type of closed loop system uses copper tubing and circulates a refrigerant through the tubing in the ground. These systems are sometimes referred to as “direct exchange” or “DX,” because the refrigerant directly transfers the heat to or from the ground, instead of the refrigerant transferring the heat to or from the heat transfer fluid which then transfers the heat to or from the ground. Presently, these, and other noncomplying systems are not allowed to be installed vertically in the ground in Minnesota except by variance.

Propylene glycol with additives must not be used in a vertical heat exchanger unless the MDH has provided written approval for that specific product. The following inhibited propylene glycols have been approved for use in vertical heat exchangers:

- **Dowfrost**, manufactured by Dow Chemical Co.
- **EnviroGard** (previously named and approved as RhoGard Ultra DP), manufactured by Rhomar Water Management, Inc.
- **Fremont 9134FG**, manufactured by Fremont Industries, Inc. Includes a range of propylene glycol dilutions with distilled water from 25 percent (9134FG-25D) to 50 percent (9134FG-50D).
- **Intercool P-323**, manufactured by Interstate Chemical Co., Inc. Includes a range of propylene glycol dilutions with de-ionized potable water from 20 percent (Intercool P-323-20) to 50 percent (Intercool P-323-50).
- **Safe-T-Therm**, manufactured by Houghton Chemical Corporation. Includes a range of propylene glycol dilutions with potable water from 20 percent (Safe-T-Therm 20 percent) to 60 percent (Safe-T-Therm 60 percent) as well as the full-strength product (Safe-T-Therm Concentrate).

## **SPECIAL WELL AND BORING CONSTRUCTION AREAS**

A Special Well and Boring Construction Area (SWBCA) is a mechanism that provides for controls on the drilling, repair, sealing, and use of wells and borings in an area where groundwater contamination has resulted in or may result in, risks to public health.

SWBCAs were first issued in 1973 as “well advisories.” The name was changed to “Special Well Construction Areas” in 1993 with revision of Minnesota Rules, Chapter 4725. A subsequent revision in 2008 changed the name to “Special Well and Boring Construction Areas.” Although the name denotes “construction”, the regulatory requirements may include sealing, repair, water testing, and treatment. The boundaries and requirements of a SWBCA may change through time, including repeal of a SWBCA, as was the case for the Andover SWBCA.

The purposes of a SWBCA are to inform the public of potential health risks in areas of groundwater contamination, provide for the construction of safe water supplies, and prevent the spread of contamination due to the improper drilling, use, or sealing of wells or borings. A SWBCA alerts the public, including property owners, drilling contractors, and local officials, to the occurrence of groundwater contamination, and the need to place special controls on the drilling of new wells and borings, and the repair and sealing of existing wells and borings. A SWBCA provides information on the contamination source, contaminants encountered, aquifers affected, and necessary restrictions. A SWBCA allows affected parties, including local units of government, to be aware of, and respond to, the contamination problem.

The rules pertaining to the construction of wells and borings place minimum restrictions on the location, construction, repair, and sealing of wells and borings. Special construction requirements are authorized in rule and statute in areas of known or suspected contamination. In order to provide safe water, it may be necessary to require the construction of deeper wells, employ special construction techniques, or conduct specialized testing. In some cases, the use of a particular aquifer may be prohibited. In severe cases, well and boring construction may be prohibited.

Contractors proposing to drill, repair or seal any well or boring in a SWBCA area must contact the Well Management Section of the MDH, or the local delegated authority where a delegated well program has jurisdiction, prior to work being done. Contractors and property owners must submit a written request and plan to the MDH or local delegated authority, and must receive written approval before construction, repair, or sealing begins.

## Map of Minnesota Special Well and Boring Construction Areas

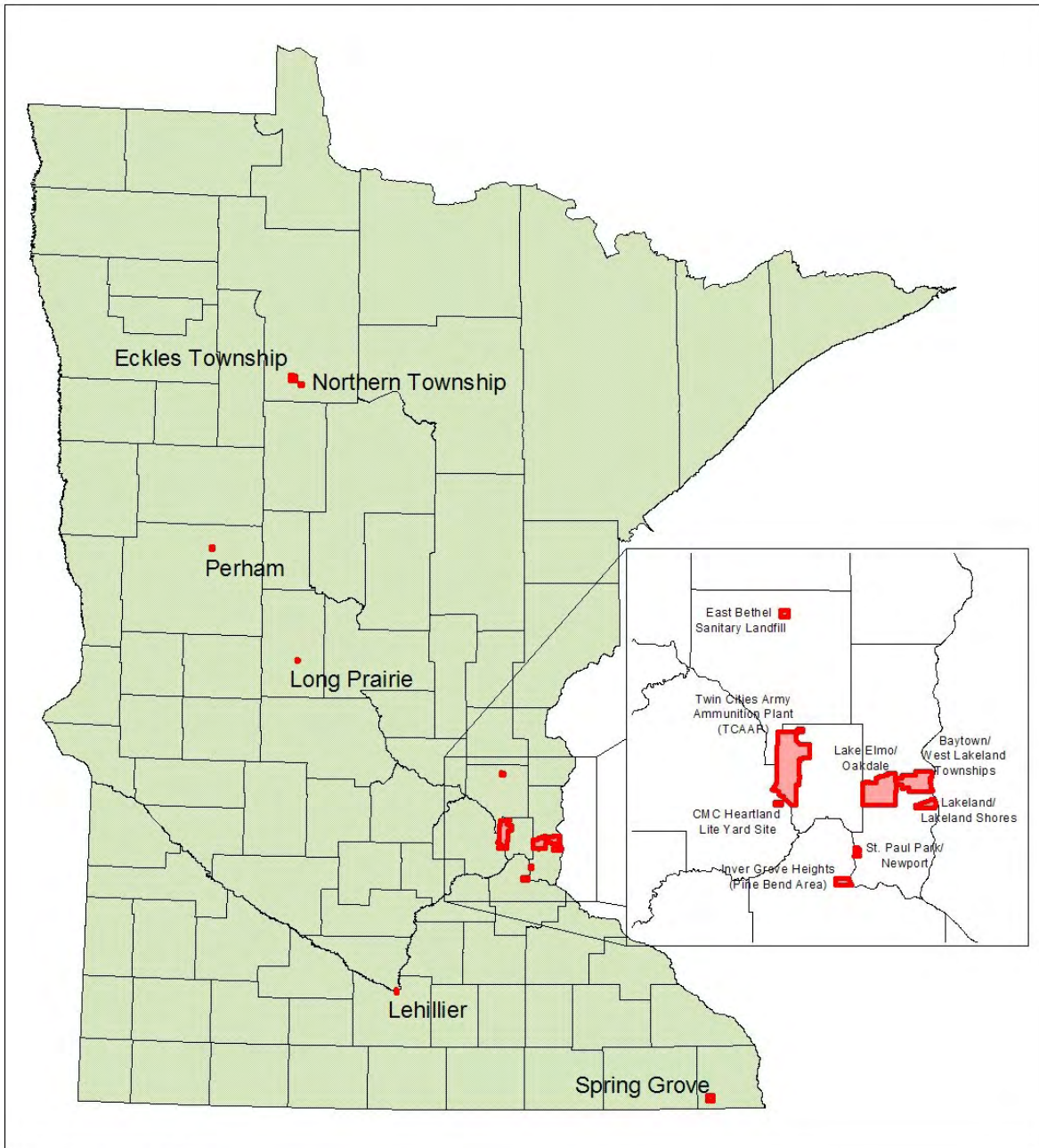

Minnesota Department of Health - Well Management Section  
January 10, 2011  
swbca state map.jpg

## SPECIAL WELL AND BORING CONSTRUCTION AREAS

February 1, 2011

### ALPHABETICAL LISTING

- **Baytown Township/West Lakeland Township/Bayport/Lake Elmo** – S 1/2 of Sections 7 and 8, Sections 9, 10, 11, 14, 15, 16, 17, 18, 20, 21, 22, 23, and N 1/2 of Section 19, T29N, R20W; and Section 13, T29N, R21W, Washington County.
- **CMC Heartland Lite Yard Site** – SE 1/4 of Section 35, and the SW 1/4 of Section 36, T29N, R24W, Minneapolis, Hennepin County.
- **East Bethel Sanitary Landfill** – E 1/2 Section 8, W 1/2 Section 9, W 1/2 of NE 1/4 of Section 9, W 1/2 and SE 1/4 Section 9, T33N, R23W, East Bethel, Anoka County.
- **Eckles Township** – Sections 13, 14, 23, and 24, T147N, R34W, Beltrami County.
- **Inver Grove Heights (Pine Bend Area)** – Sections 33, 34, 35, T27N, R22W, Dakota County.
- **Lake Elmo/Oakdale** – Sections 14-16, 19-23, and 26-35, and parts of Sections 9-11, 13, 17-18, and 24, T29N, R21W, Washington County.
- **Lakeland/Lakeland Shores/Afton/West Lakeland Township** – Parts of Sections 33, 34, and 35, T29N, R20W, and parts of Sections 2, 3, and 4, T28N, R20W, Washington County.
- **Lehillier** – Parts of Sections 14 and 23, T108N, R22W, Blue Earth County.
- **Long Prairie** – W 1/2 of SW 1/4 section 16, SE 1/4 Section 17, NE 1/4 Section 20, and W 1/2 of NW 1/4, Section 21, T129N, R33W, Todd County.
- **Northern Township (Kummer Landfill)** – Parts of Sections 32 and 33, T147N, R33W, Beltrami County.
- **Perham** – S 1/2 Section 14 and that portion of Section 23 north of State Highway 10, T136N, R39W, Otter Tail County.
- **St. Paul Park & Newport** - Parts of Sections 1, 2, 11, and 12, T27N, R22W, Washington County.
- **Spring Grove Township and Spring Grove** – Sections 11, 12, 13, and 14, T101N, R7W, Houston County.
- **Twin Cities Army Ammunition Plant (TCAAP)** – Parts of Sections 4, 9, 16 and 33, and all of Sections 7, 8, 17-22, and 27-32, T30N, R23W, Ramsey County; parts of Sections 4, 9, 16 and 31, and all of Sections 5-8, 17-20, and 29-32, T29N, R23W, Ramsey and Hennepin Counties; parts of Sections 12, 13 and 24, all of Sections 25 and 36, T30N, R24W, Anoka County; and parts of Sections 14 and 23-25, and all of Sections 1, 12, and 13, T29N, R24W, Hennepin County.

**BAYTOWN TOWNSHIP/WEST LAKELAND TOWNSHIP/BAYPORT/LAKE ELMO  
SPECIAL WELL AND BORING CONSTRUCTION AREA**

**SUMMARY**

Date SWBCA Issued: May 6, 1988  
 SWBCA Size: Approximately 12 Square Miles  
 Location: Baytown Township, West Lakeland Township, Bayport, Lake Elmo, Washington County  
 Major Contaminants: Tichloroethylene and Carbon Tetrachloride  
 Aquifers Affected: Glacial Sediments, Prairie du Chien, Jordan, Franconia

The MDH issued a Well Advisory (now a SWBCA) on May 6, 1988, for portions of Baytown Township, West Lakeland Township, and the city of Bayport because volatile organic chemicals (VOCs) were detected in drinking water wells. The SWBCA boundaries have been revised as new information has become available, and now include a portion of the city of Lake Elmo.

**SITE HYDROGEOLOGY**

The geology of the area consists of glacial deposits of loose clay and sand overlying limestone or sandstone bedrock. Glacial rivers eroded the bedrock, in some places cutting 250-foot deep valleys, and deposited the clay and sand sediments. Average glacial deposit thickness is on the order of 100 feet, overlying the Prairie du Chien in the west, the St. Peter or Platteville in isolated highlands, the Jordan in the major bedrock valley in the north, or the Franconia along the St. Croix River in Bayport. The following illustration is a typical geologic cross-section near the Lake Elmo airport.

Baytown Township  
 Approximate Geologic Column near the Lake Elmo Airport  
 Elevation 920 Feet

<u>Group or Formation</u>	<u>Depth (feet)</u>	<u>Typical Thickness (feet)</u>	<u>Bedrock Type</u>
Glacial Drift	0-90	90	clay, silt, sand
Prairie du Chien	100-225	125	dolomite, limestone
Jordan	225-305	80	sandstone
St. Lawrence	305-340	35	dolomite, shale
Franconia	340-480	140	sandstone, shale
Ironton-Galesville	480-540	60	sandstone
Eau Claire	540-630	90	siltstone, shale
Mt. Simon	630	200	sandstone

The majority of wells with detectable VOCs are drilled into the Prairie du Chien formation. However, the Jordan is affected west of the Lake Elmo Airport, and the Franconia is affected from just west of Stagecoach Trail North to the St. Croix River. The groundwater flow in the area is generally to the east, but may be affected by pumping wells, fractures in the limestone, the effect of the St. Croix River, and geologic variation.

## CONTAMINATION

In excess of 400 wells have been tested. Contaminants detected in the groundwater include trichloroethylene (TCE), carbon tetrachloride, tetrachloroethylene, and cis-1,2 dichloroethylene. The contaminant found in the greatest concentrations and over the greatest extent is trichloroethylene. The contamination has been detected in wells completed in the surficial sand aquifer, the Prairie du Chien dolomite, the Jordan sandstone, and the Franconia sandstone. The highest concentrations have been detected in the west central portions of the SWBCA. Bayport municipal wells have been affected. Lake Elmo municipal wells have not been affected.

Table 1. Chemicals Found in Baytown and Vicinity

<u>Chemical</u>	<u>Range of Concentrations</u>	<u>Water Quality Criteria</u>
Trichloroethylene	not detected – 7200 µg/L	5.0 µg/L
Carbon Tetrachloride	not detected – 1.6 µg/L	3.0 µg/L
Tetrachloroethylene	not detected – 3.8 µg/L	7.0 µg/L
cis-1,2-Dichloroethylene	not detected – 0.2 µg/L	70.0 µg/L

The TCE plume of groundwater contamination extends from the vicinity of Highway 5 on the eastern edge of Lake Elmo, to the St. Croix River. The TCE plume has a maximum width of approximately 2 miles, and a length of 5 miles where it meets the St. Croix River. The TCE source is thought to be from a former metal finishing shop, located southeast of Layton Avenue North and Highway 5 on the eastern boundary of Lake Elmo, and to a lesser extent, from activities on the Lake Elmo airport.

The carbon tetrachloride plume is limited to an area approximately 1/4-mile north-south along 40th Street starting at the railroad tracks and extending east approximately 1 mile. The source is thought to be from fumigation of grain from storage and loading facility near 40th Street and the railroad tracks.

The MPCA is investigating the sources of the volatile organic chemical contamination of the groundwater. Construction of a pumpout system east of Lake Elmo has been proposed to control the TCE source area, although the system will not capture contaminants already downstream. The carbon tetrachloride concentrations and plume extent has been shrinking, and remediation is not planned.

## BOUNDARIES OF THE SPECIAL WELL AND BORING CONSTRUCTION AREA

The SWBCA includes portions of Baytown Township, West Lakeland Township, and the cities of Bayport and Lake Elmo. The SWBCA includes the south 1/2 of Sections 7 and 8, Sections 9, 10, 11, 14, 15, 16, 17, 18, 20, 21, 22, 23, and the north 1/2 of Section 19, in T29N, R20W; and Section 13, in T29N, R21W, Washington County. The area is between the city of Lake Elmo and the St. Croix River.

## REQUIREMENTS IN THE SPECIAL WELL AND BORING CONSTRUCTION AREA

The SWBCA requires plan approval before construction of any well, or repair of existing wells. Analysis of a water sample for VOCs prior to cementing the casing has been required. Approvals have been given to construct Jordan or Franconia wells, depending on the location. The well cannot be put into use until the MDH has reviewed the water quality data and advised the well owner of actions that should be taken prior to using the water.

Baytown and West Lakeland townships have enacted ordinances requiring well owners to periodically test their water for TCE, and install whole house carbon filters if TCE concentrations exceed water quality criteria.



## **PERSONS TO CONTACT**

### Minnesota Department of Health

For information regarding the SWBCA, well construction and sealing, or plan review contact:

Patrick Sarafolean  
Well Management Section  
P.O. Box 64975  
St. Paul, Minnesota 55164-0975  
651-201-3962  
*patrick.sarafolean@state.mn.us*

For information concerning sampling and contamination investigation contact:

Virginia Yingling  
Site Assessment and Consultation Unit  
P.O. Box 64975  
St. Paul, Minnesota 55164-0975  
651-201-4930  
*virginia.yingling@state.mn.us*

### Minnesota Pollution Control Agency

For information concerning the contamination investigation and remediation contact:

Kurt Schroeder  
Superfund & Emergency Response Section  
520 Lafayette Road  
St. Paul, Minnesota 55155  
651/757-2703  
*kurt.schroeder@.state.mn.us*

**BAYTOWN TOWNSHIP/WEST LAKELAND TOWNSHIP/BAYPORT/LAKE ELMO  
SPECIAL WELL AND BORING CONSTRUCTION AREA MAP**

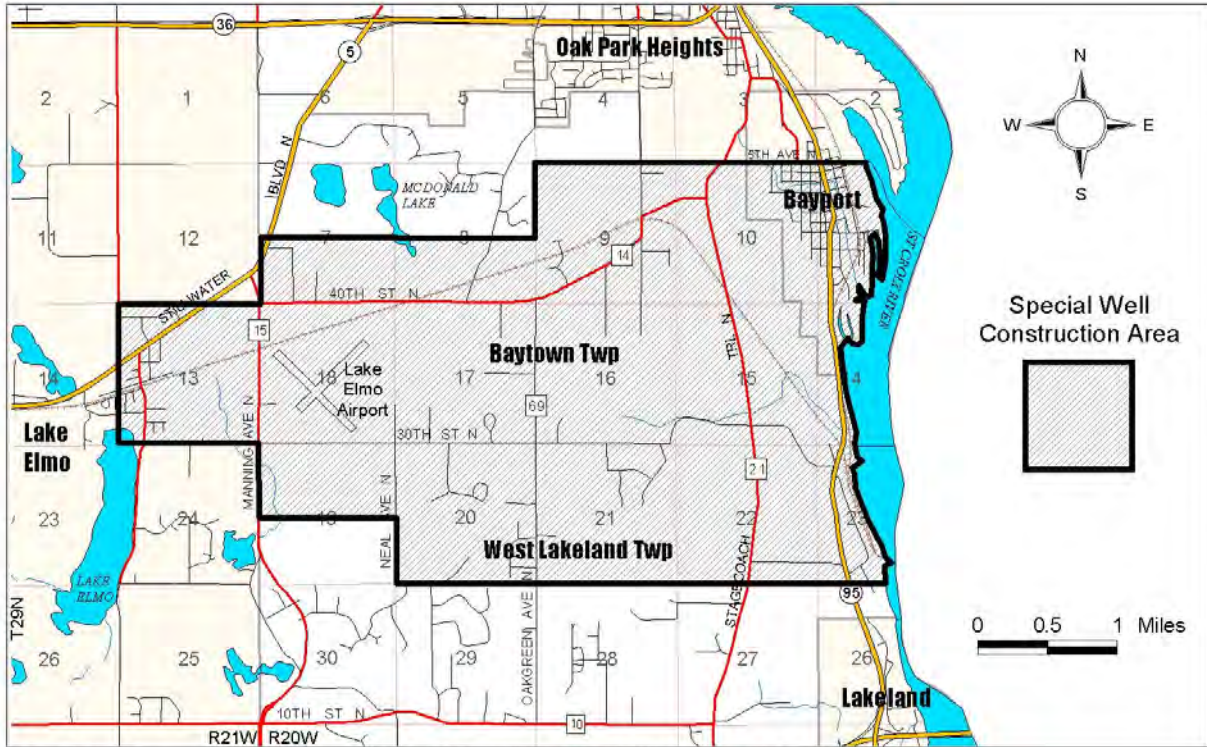

Rev. 30 Mar 05

Minnesota Department of Health - Well Management Section

## **CMC HEARTLAND LITE YARD SPECIAL WELL AND BORING CONSTRUCTION AREA**

### **SUMMARY**

Date SWBCA Issued: April 1, 2005  
SWBCA Size: Approximately 1/2 Square Mile  
Location: Minneapolis, Hennepin County  
Major contaminant: Arsenic  
Aquifers Affected: Terrace and Glacial Till Deposits

The MDH designated a Special Well Construction Area (now a SWBCA) for the CMC Heartland Lite Yard site on April 1, 2005. The SWBCA includes a portion of the city of Minneapolis, in Hennepin County. The SWBCA applies to the construction, repair, and sealing of all wells, and will remain in effect until further notice.

The former Reade Manufacturing Company five-acre property is located at the northwest intersection of Hiawatha Avenue and East 28th Street in Minneapolis. The site is currently owned by CMC Heartland and is identified as the CMC Heartland Lite Yard Site. The property is now vacant. Groundwater in the designated area is contaminated as a result of previous operations of Reade Manufacturing Company, which manufactured and packaged arsenical pesticides during 1938-63. U.S. Borax stored sodium arsenate at the site during 1963-68. Soils on the site were contaminated by these activities. Soils in the surrounding neighborhood, primarily to the northwest, have also been impacted by airborne deposition of dust blown from the site.

### **SITE HYDROGEOLOGY**

The site geology consists of fill and coarse-grained terrace deposits to depths of 18-30 feet, underlain by 25-30 feet of glacial till. The uppermost bedrock under the CMC Heartland Lite Yard site is the Platteville limestone. The southwestern corner of the SWBCA is underlain by a north-south trending bedrock valley, where the uppermost St. Peter sandstone is the first bedrock present, at a depth of 95 feet. Remnants of the Decorah shale are present in some locations above the Platteville limestone, but the Decorah is not continuous.

Groundwater flow in the unconsolidated deposits is to the west-southwest, and is estimated to be 34-81 feet per year. Groundwater flow in the St. Peter sandstone is to the northeast, and is estimated to be 150 feet per year. Flow in the St. Peter sandstone appears to be controlled by the Mississippi River.

### **CONTAMINATION**

Contamination is extensive in the site soils, with arsenic levels as high as 5000 mg/kg in some surface soils. One "hot spot" on the site showed high arsenic levels down to the groundwater, approximately 25 feet deep. The highest reported concentration in groundwater was 320,000 micrograms/liter ( $\mu\text{g/L}$ ) in monitoring well MW-9. Consumption of water containing arsenic in excess of 60,000  $\mu\text{g/L}$  may be fatal. The federal Maximum Contaminant Level (MCL) for arsenic in public water supplies, and the MDH recommended arsenic concentration in private water supplies, is 10  $\mu\text{g/L}$ . This criterion was established for long-term consumption. In the fall of 2004, the MDA excavated the "hot spot" to a depth of 27 feet (approximately the water table), removing more than 18,000 cubic yards of contaminated soil. Additional excavation of shallow soil occurred in 2005 to ensure that there is 4 feet of clean soil covering the site.

The U.S. Environmental Protection Agency (U.S.EPA), MDA, MDH, and the city of Minneapolis have been working together to identify and remediate arsenic impacted areas off-site. This off-site contamination, stemming from past airborne deposition, does not appear to threaten groundwater quality.

The U.S.EPA removed contaminated soil from 29 residential properties and refilled the excavations with clean soil. Additional soil sampling and cleanup of residential yards will be conducted by the U.S.EPA over the next few years.

Groundwater contamination is found in the terrace deposits and glacial till under the site and extending approximately 1500 feet southwest of the site, to near the vicinity of 17th Avenue South and East 29th Street. Plume dimensions are approximately 1800 feet long and 600-800 feet wide. The plume is confined to the terrace and glacial till deposits. Groundwater quality will be monitored by the MDA from the existing monitoring well network.

There are concerns for use of water for potable uses, as well as other uses that may involve contact or incidental consumption, such as for garden/lawn irrigation, filling swimming pools, and similar uses. Arsenic concentrations may be at levels that can produce severe acute health effects.

### **BOUNDARIES OF THE SPECIAL WELL AND BORING CONSTRUCTION AREA**

The location of the SWBCA is shown on the following map. The SWBCA includes the area bounded by East 26th Street on the north, 26th Avenue on the east, Lake Street on the south, and Bloomington Avenue South on the west, within the city of Minneapolis. This area includes the southeast quarter of Section 35 and the southwest quarter of Section 36 of Township 29, Range 24, Hennepin County.

### **REQUIREMENTS IN THE SPECIAL WELL AND BORING CONSTRUCTION AREA**

1. All wells regulated by the MDH and the city of Minneapolis are subject to the requirements of this SWBCA. These include water-supply wells (domestic, public, irrigation, commercial/industrial, heating/cooling, remedial), monitoring wells, and dewatering wells. Permit applications and plans for water-supply wells and monitoring wells must be submitted to the city of Minneapolis, which will then consult with MDH. Notifications and plans for dewatering wells must be submitted to the MDH, which will then consult with the city of Minneapolis. Both the city of Minneapolis and the MDH will consult with the MDA.
2. Construction of a new well, or modification of the depth of an existing well, may not take place until plans have been reviewed and approved. In addition to the normally required notification or permit application, the plan must include the following information: street address; well depth; casing type, diameter, and depth; construction method, including grout materials and grout method; pumping rate; and well use.
3. Special well construction and/or monitoring requirements may be imposed depending on well location and use in order to protect public health and groundwater quality and to prevent contaminant migration. These requirements will be based on available knowledge of groundwater contamination and movement near the well site and the proposed use and pumping rate of the well.
4. Water-supply wells will not be approved for completion in the terrace deposits, glacial drift, Platteville limestone, or St. Peter sandstone in the SWBCA for any consumptive uses or other uses involving human contact, including drinking, cooking, bathing, manufacturing or processing of food, drink, or pharmaceuticals, or to supply water to plumbing fixtures accessible to humans.
5. For all water-supply wells (including remedial wells), dewatering wells, and monitoring wells, a sampling plan and schedule to monitor arsenic concentrations must be submitted and approved prior to start of well construction. Approvals must be obtained from the appropriate local and/or state agencies for any discharge of water from these wells.

Well construction or reconstruction will not be approved if the MDH and city of Minneapolis, in consultation with the MDA, conclude that the proposed construction or reconstruction may interfere with remediation efforts, cause further spread of contamination, or result in human exposure to contaminants at concentrations exceeding U.S.EPA Maximum Contaminant Levels (MCLs) or Minnesota Health Risk Limits (HRLs).

The permanent sealing of a well completed in bedrock may not take place until after the MDH and the city of Minneapolis (water-supply wells and monitoring wells) have reviewed and approved the plans for the proposed sealing. In addition to the required notification or permit, the plan must include the following information: street address; original well depth; current well depth; casing type(s), diameter(s), depth(s); methods for identifying and sealing any open annular space; methods for identifying and removing any obstructions; and grout materials and methods.

## **PERSONS TO CONTACT**

### Minnesota Department of Health

For additional information regarding this Special Well and Boring Construction Area, contact:

Michael Convery  
Well Management Section  
P.O. Box 64975  
St. Paul, Minnesota 55164-0975  
651-201-4586.  
*michael.convery@state.mn.us*

For information on well construction or sealing and submission of plans contact:

Patrick Sarafolean (water-supply, monitoring wells, and dewatering wells)  
Well Management Section  
P.O. Box 64975  
St. Paul, Minnesota 55164-0975  
651-201-3962  
*patrick.sarafolean@state.mn.us*

For information regarding health effects, please contact:

Daniel Peña  
Site Assessment and Consultation Unit  
P.O. Box 64975  
St. Paul, Minnesota 55164-0975  
651-201-4920  
*daniel.pena@state.mn.us*

### City of Minneapolis

For information on well construction or sealing and submission of plans contact:

Alison Fong (water-supply and monitoring wells)  
City of Minneapolis - Environmental Management  
250 South Fourth Street, Room 414  
Minneapolis, Minnesota 55415  
612-673-3179 (office)  
*alison.fong@ci.minneapolis.mn.us*

Minnesota Department of Agriculture

For information regarding the investigation, monitoring, and remediation of the CMC Heartland Lite Yard Site and of the surrounding neighborhood, please contact:

Cathy Villas-Horns  
Minnesota Department of Agriculture  
Pesticide & Fertilizer Management Division  
Orville L. Freeman Building  
625 Robert Street North  
St. Paul, Minnesota 55155-2538  
651-201-6697  
*cathy.villas-horns@state.mn.us*

Robert Anderson  
Minnesota Department of Agriculture  
Pesticide & Fertilizer Management Division  
Orville L. Freeman Building  
625 Robert Street North  
St. Paul, Minnesota 55155-2538  
651-201-6632  
*robert.anderson@state.mn.us*

**CMC HEARTLAND LITE YARD  
SPECIAL WELL AND BORING CONSTRUCTION AREA MAP**

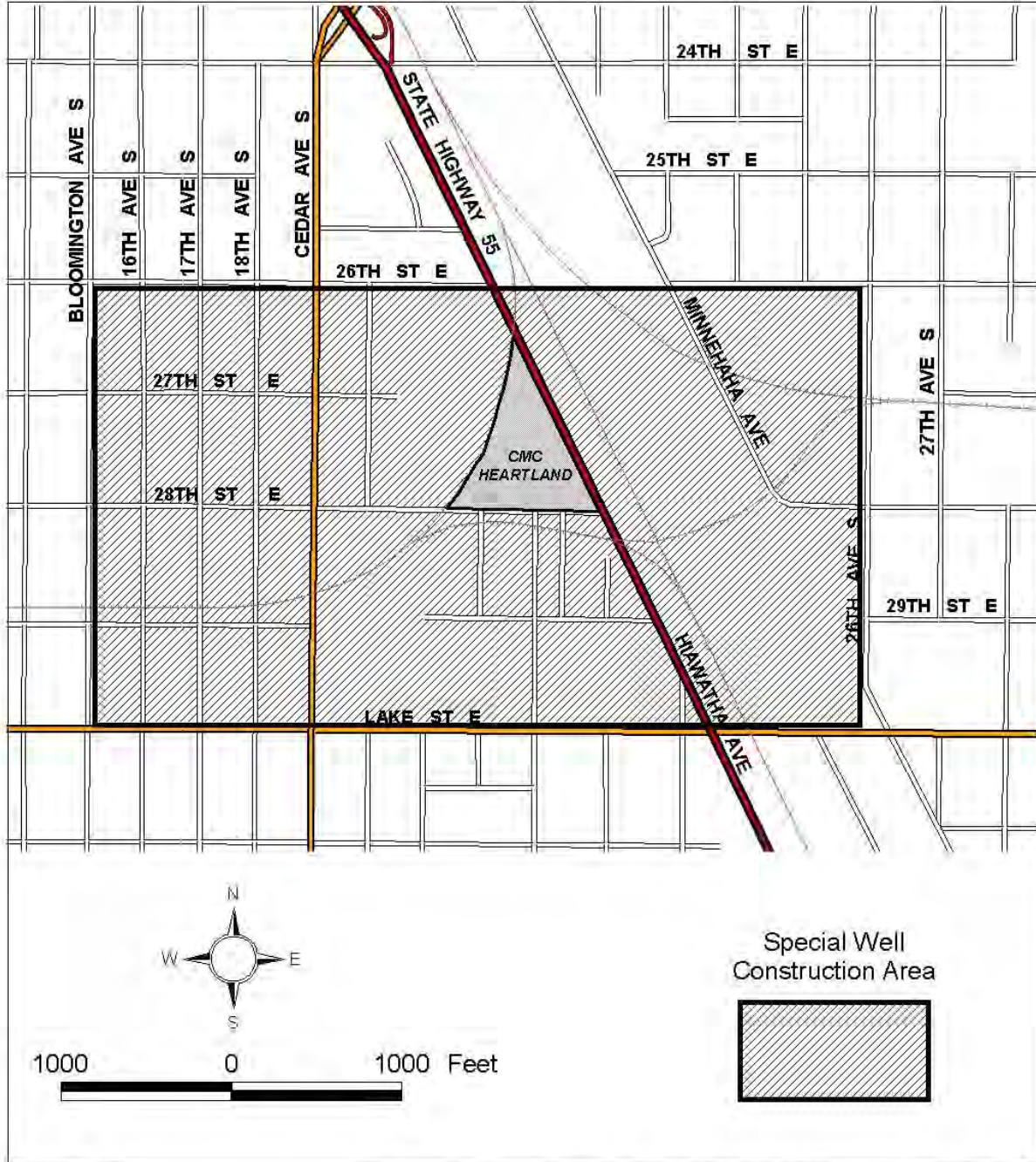

17 Mar 05

Minnesota Department of Health - Well Management Section

## **EAST BETHEL LANDFILL SPECIAL WELL AND BORING CONSTRUCTION AREA**

### **SUMMARY**

Date SWBCA Issued : March 15, 1998

SWBCA Size: Approximately 1-1/4 Square Miles

Location: East Bethel, Anoka County

Major Contaminants: benzene, 1,1-dichloroethane, 1,1-dichloroethylene, 1,2-dichloroethylene, and tetrahydrofuran

Aquifers Affected: Surficial and Buried Sands

The East Bethel Landfill, located in Section 8 of East Bethel Township, received a permit to accept mixed municipal wastes in 1971. The landfill accepted predominately demolition debris, and limited amounts of municipal and industrial wastes, receiving approximately 1.2 million cubic yards of waste. The landfill closed in 1995. The MDH designated a Special Well Construction Area (SWCA), now a SWBCA, for portions of the city of East Bethel, in Anoka County, as shown on the attached map, effective March 15, 1998, due to Volatile Organic Chemical (VOC) contamination of groundwater.

### **SITE HYDROGEOLOGY**

Area geology consists of a surficial sand deposit, typically 20 to 60 feet deep, underlain in places by discontinuous Grantsburg till deposit up to 20 feet thick, below which is an additional 10 to 30 feet of sand. Below this is 10 to 50 feet of Superior till. The top of the uppermost bedrock, the Franconia formation, is found at depths of 100 to 150 feet. The water table is found in the surficial sand at depths from 0 to 30 feet. Groundwater flow is generally to the south and southwest.

### **CONTAMINATION**

Groundwater in portions of the designated area has been contaminated as a result of operation of the East Bethel Sanitary Landfill. Groundwater contamination extends beneath most of the landfill site, and for several hundred feet beyond the landfill borders to the south and west. Several VOCs have been detected off-site in excess of Health Risk Limits (HRLs).

Contamination has been found in both the surficial and buried sand deposits above the Superior till. No contamination has been found in monitoring wells completed in the Franconia formation. Hard clay and silt layers in the Superior till appear to be acting as a confining layer.

The MPCA has implemented remedial measures at the now closed landfill, including a landfill cover system, passive gas venting system, and a groundwater pumpout system. The pumpout system runs seasonally, from April to the end of October.

### **BOUNDARIES OF THE SPECIAL WELL AND BORING CONSTRUCTION AREA**

The Special Well and Boring construction Area (SWBCA) includes the E 1/2 of Section 8, W 1/2 of Section 9, W 1/2 of the NE 1/4 of Section 9, and the W 1/2 & SE 1/4 of Section 9, T33N, R23W; in the City of East Bethel, Anoka County. Beginning at the intersection of State Highway 65 and Sims Road Northeast, the boundary of the SWBCA extends north on State Highway 65 approximately 1 mile to 221st Avenue Northeast, then east on 221st Avenue Northeast approximately 1-1/4 miles, then south approximately one mile, then west approximately one and one quarter miles to the intersection of State Highway 65 and Sims Road.

The location of the SWBCA is shown on the following map.



## **REQUIREMENTS IN THE SPECIAL WELL AND BORING CONSTRUCTION AREA**

The MDH and MPCA are concerned that the construction of new wells or modification of existing wells within the SWBCA may interfere with cleanup efforts, or may cause further spread of the contamination, especially during the winter when the pumpout system is idle. The MDH and the MPCA are also concerned about the public health effects that could result from the use of water-supply wells in the contaminated aquifers prior to completion of the cleanup effort. It is also important to assure that unused wells are properly sealed.

1. All wells regulated by the MDH are subject to the requirements of this SWBCA. This includes potable water-supply wells, irrigation wells, commercial and industrial water-supply wells, wells for heating and cooling, remedial wells, monitoring wells, and dewatering wells.
2. Construction of a new well, or modification of the depth of an existing well, may not take place until after the MDH has reviewed and approved plans for the proposed construction. In addition to the required permit application or notification, the plan must include the following information: street address; well depth; casing type, diameter, and depth; method of construction, including grout materials and grout method; pumping rate; and well use.
3. Special well construction and/or monitoring requirements may be imposed on a case-by-case basis in order to protect groundwater quality and prevent migration of contaminants. These requirements will be based on available knowledge of groundwater contamination and movement near the well site, and the proposed use and pumping rate of the well. Special requirements may include completion of the well in or below the Franconia formation, with casing and grout emplaced through all overlying formations.
4. Well construction or reconstruction will not be approved if the MDH, in consultation with the MPCA, concludes that the proposed construction or reconstruction may interfere with cleanup efforts, cause further spread of contamination, or result in human exposure to contaminants at concentrations exceeding MDH's Health Risk Limits (HRLs).
5. If the proposed construction or reconstruction of a potable water-supply well is approved, the MDH may require that one or more water samples be collected and analyzed for VOCs before the well is grouted and put into service. If contamination is present in excess of HRLs, the well must be permanently sealed or reconstructed.
6. The permanent sealing of a well completed in bedrock may not take place until after the MDH has reviewed and approved plans for the proposed sealing. In addition to the required well sealing notification, the plan must include the following information: street address; original well depth; current well depth; casing type(s), diameter(s) and depth(s); methods for identifying and sealing any open annular space; methods for identifying and removing any obstructions; and grout material and methods.

## **PERSONS TO CONTACT**

### Minnesota Department of Health

For additional information regarding the SWBCA, contact:

Ed Schneider  
Well Management Section  
P.O. Box 64975  
St. Paul, Minnesota 55164-0975  
651-201-4595  
*ed.schneider@state.mn.us*

For information regarding plan review, well construction and well sealing, or water sampling contact:

Patrick Sarafolean  
Well Management Section  
P.O. Box 64975  
St. Paul, Minnesota 55164-0975  
651-201-3962  
*patrick.sarafolean@state.mn.us*

### Minnesota Pollution Control Agency

For information regarding contamination investigation, monitoring, and remediation contact:

Jean Hanson  
Petroleum & Closed Landfill Section  
520 Lafayette Road  
St. Paul, Minnesota 55155  
651-757-2408  
*jean.hanson@state.mn.us*

Joe Julik  
Petroleum & Closed Landfill Section  
520 Lafayette Road  
St. Paul, Minnesota 55155  
651-757-2479  
*joseph.julik@state.mn.us*

**EAST BETHEL SANITARY LANDFILL  
SPECIAL WELL AND BORING CONSTRUCTION AREA MAP**

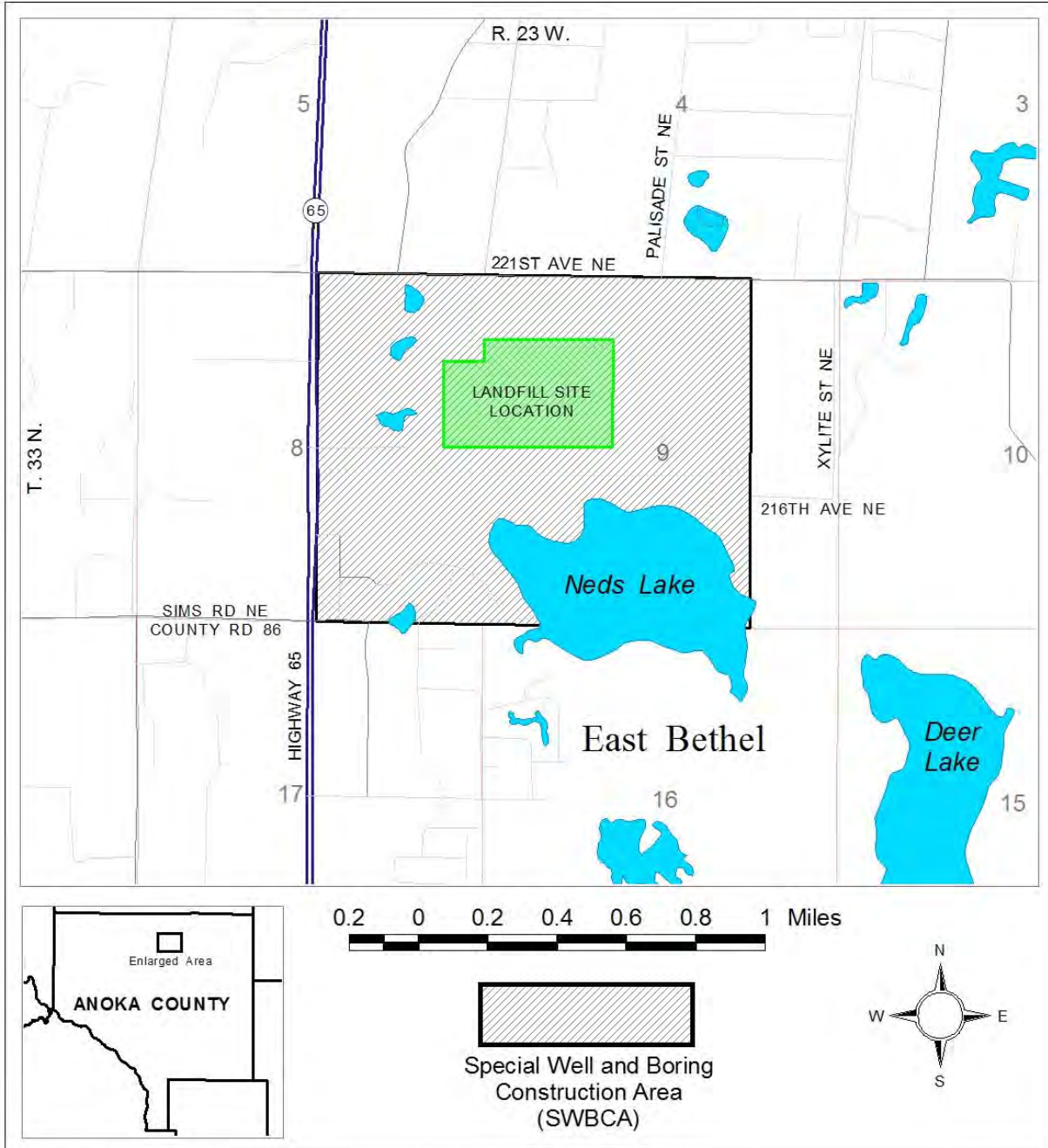

Minnesota Department of Health - Well Management Section  
 May 21, 2010  
 ebethel2010.apr

## **ECKLES TOWNSHIP SPECIAL WELL AND BORING CONSTRUCTION AREA**

### **SUMMARY**

Date SWBCA Issued: September 1, 2006  
SWBCA Size: 4 square miles  
Location: Eckles Township, Beltrami County  
Major Contaminant: Nitrate  
Aquifers Affected: Glacial Sediments

In Section 14 of Township 147, Range 34, Eckles Township, Beltrami County, previous agricultural practices appear to have resulted in groundwater quality impacts. Testing of new water-supply wells in this area indicate that groundwater in the surficial sand aquifer contains nitrate-nitrogen concentrations up to 27 milligrams/liter (mg/L).

Some water-supply wells have been constructed through the surficial sand aquifer and a clay confining layer, into an underlying confined sand aquifer. Wells that were cased and fully grouted through the clay confining layer have nondetectable or low levels of nitrate. Some wells, however, were only grouted to the minimum depth of 30 feet as previously required under Minnesota Rules, part 4725.3050, subpart 3, which in some cases was above the clay confining layer. The deeper annular space on these wells was filled with either cuttings or collapsed material, which does not provide an adequate annular seal. Consequently, although these wells were completed into the confined sand aquifer and would normally be protected from contamination from the surficial sand aquifer, they also have nitrate contamination, apparently due to groundwater migrating from the upper sand aquifer through the annular space around the well casing, into the underlying confined sand aquifer. These wells have been reconstructed or sealed. In general, wells that are grouted into the clay confining layer do not experience nitrate contamination.

### **SITE HYDROGEOLOGY**

This area of Eckles Township is underlain by 15-35 feet of surficial sand, identified as outwash sand deposited by glacial meltwater. This sand is an unconfined aquifer, with static water levels of approximately 10-15 feet below the ground surface. In the northeast quarter of Section 14, a clay layer having a thickness of 15-50 feet underlies the surficial sand unit. The clay layer is a glacial till or a glacial lake deposit. However, the continuity of the clay layer is unknown. Some well records (e.g., Minnesota Unique Well Numbers 722522 and 722523) beyond this quarter indicate the presence of the clay unit, while others records (e.g., Minnesota Unique Well Numbers 213456 and 564746) do not. Regardless of the presence of the clay layer, sand continues to a depth beyond 100 feet. In the Bemidji area, this clay layer serves as a confining layer to the underlying confined aquifer, which is up 60 feet thick. The entire thickness of glacial deposits in the Bemidji-Bagley area is up to 550 feet, making it likely that additional aquifer units and confining layers may be present. In terms of yield, both the surficial and upper confined aquifers are considered to be highly productive.

Groundwater flow is not well defined, but is expected to be to the east-southeast towards Lake Bemidji and the Mississippi River, which is the regional discharge for both the unconfined aquifer and the uppermost confined aquifer. However, local groundwater flow patterns may discharge to local wetlands and smaller water bodies, and may be influenced by heavy withdrawals, such as those associated with irrigation wells.

## **CONTAMINATION**

In 1989, the United States Geological Survey (USGS) noted that the unconfined, surficial sand aquifer is susceptible to contamination from land use activities, while the confined aquifer is relatively well protected. These observations have been confirmed with findings of nitrate concentrations consistently exceeding 20 mg/L in the unconfined sand aquifer in the northeast quarter of Section 14. The clay confining layer appears to prevent natural migration into the underlying confined sand aquifer. Wells that have been completed in this confined sand aquifer and grouted through the clay confining layer show much lower or no detectable nitrate concentrations. However, wells that were completed in the confined sand aquifer but not grouted into or through the clay confining layer show nitrate levels more consistent with the surficial sand aquifer. In those wells that were not grouted into or through the clay confining layer, it appears that groundwater from the surficial sand aquifer has migrated through the annular space around the casing into the confined sand aquifer.

## **BOUNDARIES OF THE SPECIAL WELL AND BORING CONSTRUCTION AREA**

The location of the SWBCA is shown on the map and includes Sections 13, 14, 23, and 24 of Township 147, Range 34, Eckles Township, Beltrami County. The SWBCA is broken into two zones (Zone A and Zone B), with different requirements for each zone.

Zone A consists of the NE 1/4 and the N 1/2 of the SE 1/4 of Section 14 of Township 147, Range 34, Eckles Township. Zone B consists of the remainder of Section 14 and Sections 13, 23, and 24 of Township 147, Range 34, Eckles Township.

## **REQUIREMENTS IN THE SPECIAL WELL AND BORING CONSTRUCTION AREA**

All wells and borings regulated by the MDH are subject to the requirements of the SWBCA. Wells include water-supply well (domestic, public, irrigation, commercial/industrial, cooling/heating, remedial) monitoring wells, and dewatering wells. Borings include elevators, environmental bore holes, and vertical heat exchangers. Permit applications and notifications must be submitted to the MDH.

**The requirements for Zone A and Zone B are as follows:**

### **ZONE A**

1. Construction or modification of the depth, of a well or boring within Zone A may not occur until plans have been reviewed and approved by the MDH. In addition to the normally required notification or permit, the plan must include the following information: street address; well or boring depth; casing type, diameter, and depth; construction method(s), including grout materials and grout methods; well pumping rate; and well use. A well or boring that penetrates the clay confining layer must be cased and grouted through the clay confining layer(s) to within 10 feet of the well screen.
2. No potable water-supply wells may be completed in the surficial sand aquifer in Zone A. For purposes of this SWBCA, potable uses include any consumptive uses, such as drinking, cooking, bathing, manufacturing or processing food, drink, or pharmaceuticals, or to supply water to fixtures accessible to humans.
3. Special construction and/or monitoring requirements may be imposed on well/boring completion and use in order to protect public health and groundwater quality and to prevent contaminant migration. These requirements will be based on available knowledge of groundwater contamination and movement near the well site and the proposed use and pumping rate of the well.

4. In addition to plan approval by MDH, contractors must notify the MDH Northwest district office by phone at least 24 hours prior to the start of construction of a new well/boring or modification of the depth of an existing well/boring in Zone A to enable MDH to be on-site during work.
5. Sealing of wells and borings in Zone A may not occur until plans have been reviewed and approved by the MDH. In addition to the normally required notification, the plan must include the following information: street address; well or boring depth; casing type, diameter, and depth; grout depth (if applicable), presence of open annular spaces, and proposed sealing method, including grout materials and grout placement. For those wells that are cased through a confining layer(s) and may have an ungrouted annular space around the casing, the MDH may require that the well casing be removed, perforated, or overdrilled through the confining layer(s) to enable proper sealing both inside and around the casing.
6. Contractors must notify the MDH Bemidji district office by phone at least 24 hours and one business day (Monday-Friday) prior to the start of sealing a well or boring within Zone A.
7. All provisions of Minnesota Rules, Chapter 4725, are in effect.

## **ZONE B**

1. For wells and borings to be located within Zone B, well contractors must notify the MDH Bemidji district office by phone at least 24 hours and one full business day (Monday-Friday) prior to start of drilling to enable MDH staff to be on site during drilling in order to determine geology and to provide well contractors with current information on the hydrogeology and water quality in these areas. There are no additional construction or monitoring requirements at this time. This contact is in addition to the normally required notification or permit.
2. Sealing of wells and borings in Zone B may not occur until plans have been reviewed and approved by the MDH. In addition to the normally required notification, the plan must include the following information: street address; well or boring depth; casing type, diameter, and depth; grout depth (if applicable), presence of open annular spaces, and proposed sealing method, including grout materials and grout placement. For those wells that are cased through a confining layer(s) and may have an ungrouted annular space around the casing, the MDH may require that the well casing be removed, perforated, or overdrilled through the confining layer(s) to enable proper sealing both inside and around the casing.
3. Contractors must notify the MDH Bemidji office by phone at least 24 hours and one business day (Monday-Friday) prior to the start of sealing a well or boring within Zone B.
4. All provisions of Minnesota Rules, Chapter 4725, are in effect.

## **PERSONS TO CONTACT**

For additional information regarding the SWBCA, please contact Michael Convery at 651-201-4586.

Plans for the construction, modification/repair, and sealing of wells and borings must be submitted to the MDH Northwest district office (Bemidji) for review and approval at least three working days prior to start of work. Phone notification for construction, modification/repair, and sealing of wells and borings within the SWBCA must be provided at least 24 hours prior to start of work to:

Mark Malmanger/Kelly Jorgenson  
Minnesota Department of Health – Northwest District  
705 Fifth Street Northwest  
Bemidji, Minnesota 56601  
218-308-2100  
*mark.malmanger@state.mn.us/kelly.jorgensen@state.mn.us*

**NOTE:** Notifications and permits required for the construction, modification, and sealing of wells and borings, as required by Minnesota Rules, Chapter 4725, must still be mailed or faxed to the MDH Well Management Section central office at: Minnesota Department of Health  
Well Management Section  
P.O. Box 64502  
St. Paul, Minnesota 55164-0502  
Fax Number: 651-201-4599

# ECKLES TOWNSHIP SWCA SPECIAL WELL AND BORING CONSTRUCTION AREA MAP

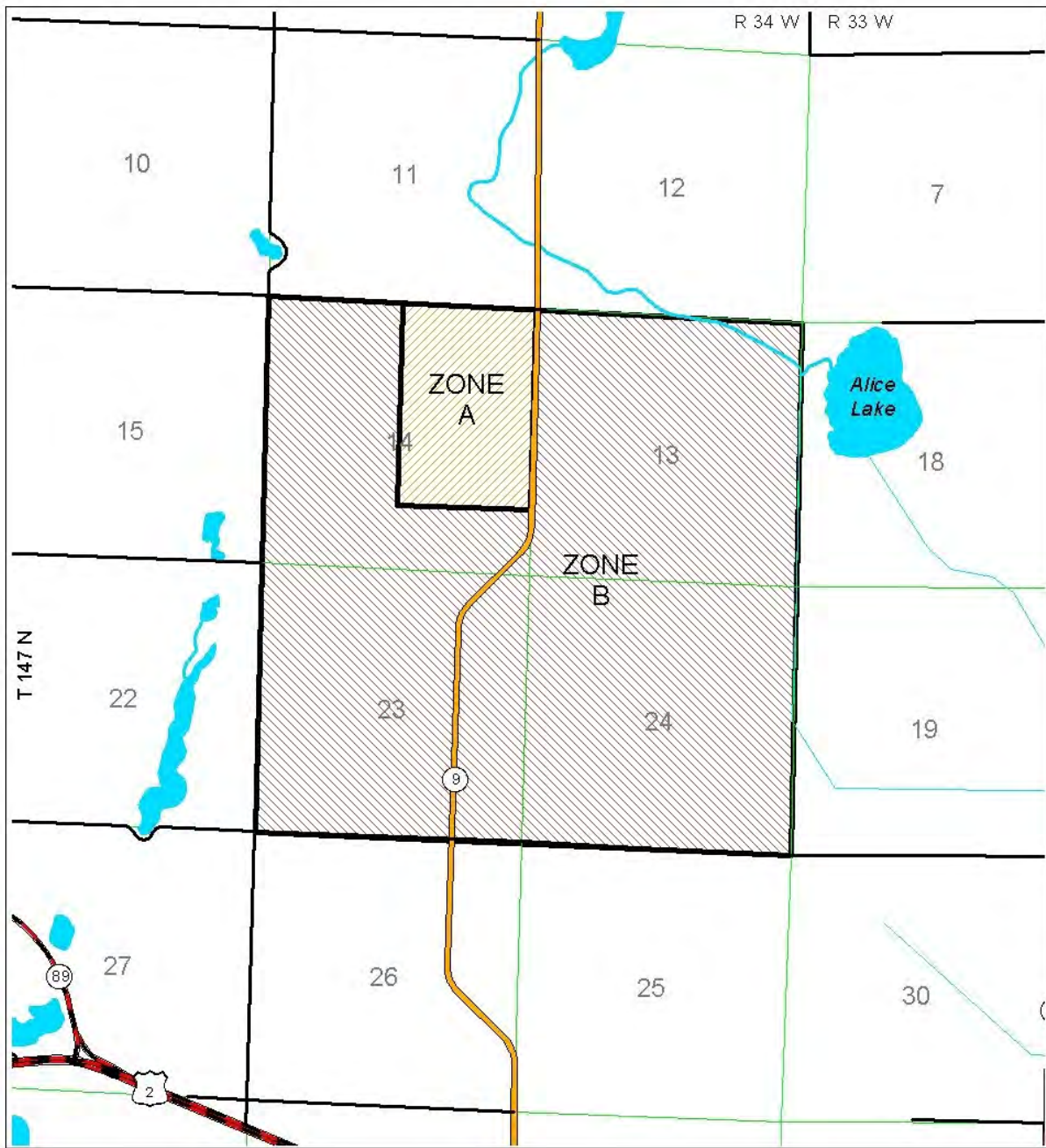

Special Well Construction Area

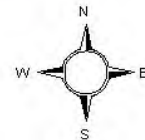



## **INVER GROVE HEIGHTS (PINE BEND AREA) SPECIAL WELL AND BORING CONSTRUCTION AREA**

### **SUMMARY**

Date SWBCA Issued: April 19, 1973  
SWBCA Size: Approximately 2 Square Miles  
Location: Inver Grove Heights, Dakota County  
Major Contaminants: 1,1, trichloroethane, cis-1,2 dichloroethylene, 1,1,dichloroethane, 1,2 dichloroethane, chloroform, toluene, chlorinated fluoromethanes (freons) and ethyl ether  
Aquifers Affected: Glacial Sediments

The Pine Bend area of Inver Grove Heights, Dakota County, is located approximately 10 miles south of St. Paul and 1/2 to 1 mile west of the Mississippi River. Koch Refining, now Flint Hill Resources, was constructed in the 1950s to refine high-sulfur crude oil imported by pipeline from the oil fields of the Province of Alberta, Canada. Numerous petro-chemical industries associated with the refinery were built in the area. Crosby-American Landfill was issued a solid waste permit in 1970 and closed in 1989. Approximately 1.4 million cubic yards of waste were accepted at the Crosby-American facility with approximately 0.5 million being mixed municipal wastes and the remainder largely demolition and construction waste. Pine Bend Landfill was first permitted in 1971, and continues to operate, accepting mixed municipal wastes. Pine Bend Landfill is permitted for over 20 million cubic yards of waste.

In December 1972, in response to complaints to the MPCA from well owners about tastes and ammonia odors, the MDH sampled a number of wells to the east of the refinery. Reports from the refinery indicated that process water holding ponds were leaking millions of gallons of waste water to the ground. The sampling program was expanded in 1972. Contamination with metals, phenols, ammonia, and lowered pH was reported.

On April 19, 1973, the MDH contacted the village of Inver Grove Heights requesting their assistance to control well construction in Sections 33, 34, and 35, T27N, R22W. The MDH requested that, before any well permit is issued for construction of a new well or reconstruction of an existing well, the MDH be contacted. The April 19, 1973, well advisory, now a SWBCA, is slightly more than 2 square miles in size.

### **SITE HYDROGEOLOGY**

The geology of the area consists of varying thicknesses of glacial sediments and alluvium overlying bedrock, ranging from the Prairie du Chien formation, to the Franconia in the center of a deep buried bedrock valley. The bedrock valley is 450 feet deep in some areas. Groundwater flow is generally to the east and northeast toward the Mississippi River.

### **CONTAMINATION**

A series of hydrologic investigations have been conducted. The Koch, Northstar, and St. Paul Ammonia sites were combined into a single Permanent List of Priorities (PLP) site (superfund) by the MPCA. The Pine Bend and Crosby-American Sites were combined into a single PLP site. Groundwater monitoring has detected the presence of Volatile Organic Chemicals (VOCs), which are apparently associated with both sites. Solvents have been primarily detected near the landfills, and petroleum products near the industrial sites.

Thirty-one different VOCs have been detected in monitoring wells at the landfill. Groundwater samples taken from 21 residential and commercial wells completed in glacial sediments have shown VOC's including 1,1, trichloroethane, cis-1,2 dichloroethylene, 1,1,dichloroethane, 1,2 dichloroethane, chloroform, toluene, chlorinated fluoromethanes (freons) and ethyl ether. Residents east of the landfills have been issued advisories by the MDH to discontinue use of the water for drinking and food preparation due to concentrations of VOC's exceeding HRLs. Municipal water was extended to the area in 1994. The refinery has purchased properties where wells have been affected. The landfills have installed gas extraction and recovery wells. An interceptor trench system downgradient of the refinery has recovered over 3 million gallons of petroleum products from the groundwater.

#### **BOUNDARIES OF THE SPECIAL WELL AND BORING CONSTRUCTION AREA**

The Inver Grove Heights SWBCA is located in Sections 33, 34, and 35, T27N, R22W, Dakota County. The area is bounded by the Mississippi River on the East, the dividing line between township 27N and township 115 on the south, the dividing line between sections 32 and 3 on the west, and the dividing line between sections 33 and 34 with sections 27 and 28 on the north.

#### **REQUIREMENTS IN THE SPECIAL WELL AND BORING CONSTRUCTION AREA**

The Inver Grove Heights SWBCA is administered jointly by the Dakota County delegated well program and the MDH.

Prior to well construction, a permit must be obtained from the Dakota County Environmental Services Department, and plan approval received from the MDH.

#### **PERSONS TO CONTACT**

##### Minnesota Department of Health

For information regarding plan review, well construction and well sealing, or water sampling contact:

Patrick Sarafolean  
Well Management Section  
P.O. Box 64975  
St. Paul, Minnesota 55164-0975  
651-201-3962  
*patrick.sarafolean@state.mn.us*

##### Dakota County Environmental Services Department

Jeff Luehrs  
Dakota County Environmental Services  
14955 Galaxie Avenue West  
Apple Valley, Minnesota 55124  
952-891-7553  
*jeff.luehrs@co.dakota.mn.us*

Minnesota Pollution Control Agency

For information regarding the investigation, monitoring, and remediation of the contamination contact:

Shawn Ruotsinoja  
Petroleum & Closed Landfill Section  
520 Lafayette Road  
St. Paul, Minnesota 55155  
651-757-2683  
*shawn.ruotsinoja@state.mn.us*

Joe Julik  
Petroleum & Closed Landfill Section  
520 Lafayette Road  
St. Paul, Minnesota 55155  
651-757-2479  
*joseph.julik@state.mn.us*

**INVER GROVE HEIGHTS (PINE BEND AREA)  
SPECIAL WELL AND BORING CONSTRUCTION AREA MAP**

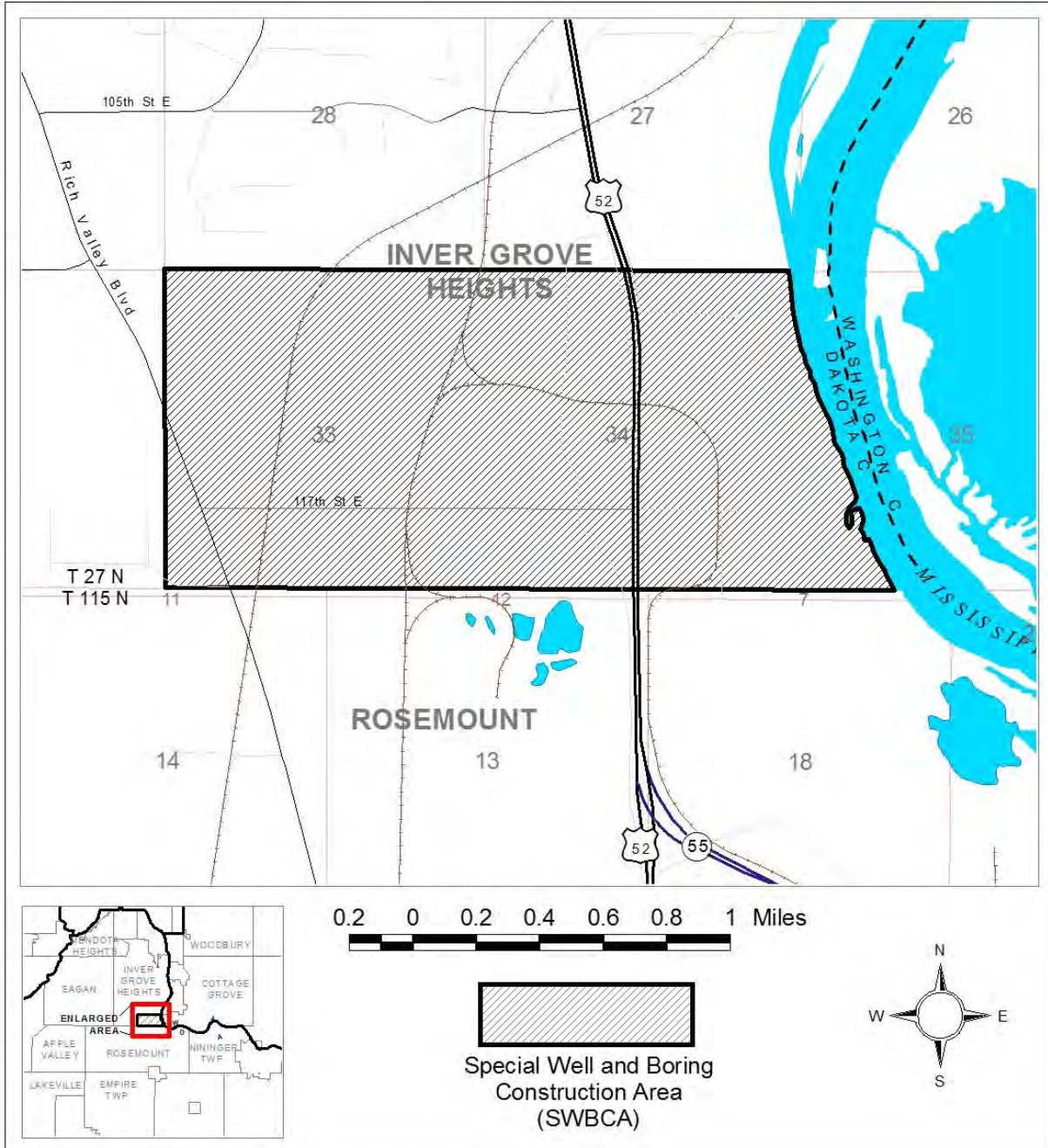

Minnesota Department of Health - Well Management Section  
May 21, 2010  
igh pine bend swbca2.apr

## **LAKE ELMO/OAKDALE SPECIAL WELL AND BORING CONSTRUCTION AREA**

### **SUMMARY**

- Date SWBCA Issued: March 8, 2007 (amended and expanded July 19, 1982, Washington County Landfill SWCA)
- SWBCA Size: Approximately 20 Square Miles
- Location: Lake Elmo and Oakdale, Washington County (the SWBCA is in Oakdale and Lake Elmo, however the contaminant plume also includes parts of Woodbury, Cottage Grove, Afton, Grey Cloud Island, Hastings, Newport, South St. Paul, St. Paul Park)
- Major Contaminants: PFCs including PFOA and PFOS (also including PFBA, and TCE, tetrachloroethylene)
- Aquifers Affected: Glacial Sediments, St. Peter, Prairie du Chien, Jordan, Franconia

The MDH has designated a Special Well and Boring Construction Area (SWBCA), which includes portions of Lake Elmo and Oakdale in Washington County, Minnesota (see Figure 1). The SWBCA designation is effective March 15, 2007, and applies to the construction repair, modification, and sealing of wells and borings. The SWBCA designation remains effective until further notice. This designation is an expansion and renaming of the existing Washington County Landfill SWBCA, originally established in 1982. This expansion includes the Oakdale disposal site. The SWBCA addresses the finding of more extensive groundwater contamination by perfluorochemicals in Lake Elmo and Oakdale.

### **AUTHORITY**

Minnesota Statutes, section 103I, subdivision 5, clause 7 grants the Commissioner of Health the authority to establish standards for the construction, maintenance, sealing, and water-quality monitoring of wells in areas of known or suspected contamination. Minnesota Rules, part 4725.3650, details the requirements for construction, repair, and sealing of wells within a designated SWBCA, including plan review and approval, water-quality monitoring, and other measures to protect public health and prevent degradation of groundwater.

### **SITE HISTORIES**

The Washington County Landfill is located approximately one-quarter mile south of Lake Jane in Lake Elmo, Minnesota. It was initially permitted as a solid waste landfill by the MPCA in 1969 and operated until 1975. The landfill received approximately 2.5 million cubic yards of municipal and industrial wastes (MPCA 2004). In 1981, sampling of on-site monitoring wells and off-site private wells to the south and southwest indicated the presence of volatile organic chemicals (VOCs), including trichloroethylene and tetrachloroethylene, and metals in groundwater. A "Well Advisory," of approximately 1 square mile, was established on July 19, 1982. The advisory covered an area from the landfill south to Highway 5. The advisory boundaries were revised in 1983 and, in 1993, the advisory became a SWCA. Due to the presence of VOC contamination, the SWCA required persons proposing to construct or seal wells within the SWCA to obtain written plan approval from the MDH prior to beginning work. This SWCA has been in effect to the present.

In 1983, Ramsey and Washington Counties installed a groundwater remediation system, including a gradient control well system with spray irrigation to remove VOCs. In 1996, the site entered the MPCA-administered Closed Landfill Program and the MPCA has taken additional steps to improve the landfill cover and the groundwater remediation system. Municipal water service, provided by the Oakdale municipal system, was extended into the SWCA in 1986, and private wells were sealed.

The Oakdale disposal site (actually three sites – Abresch, Brockman, and Eberle) was used in the 1940's through 1960's for disposal of commercial, industrial, and residential wastes. Disposal was via burying containers and solid materials in trenches, dumping liquids on the ground or in pits, and burning materials in pits. The site investigation began in 1980. Contaminants detected at the site include methyl ethyl ketone, acetone, toluene, isopropyl ether, and other VOCs. A number of remedial actions were taken, including excavation and disposal/incineration of wastes and contaminated soils, sealing 39 multiaquifer (Platteville limestone – St. Peter sandstone) wells and connecting potentially affected well owners to the Oakdale municipal water supply, installation and operation of a groundwater remediation system (12 extraction wells) in the unconsolidated aquifers, and installation of a groundwater monitoring system (Minnesota Department of Health, 1993).

### **PERFLUOROCHEMICALS**

In 2003, the MPCA began investigating a family of chemicals called “perfluorochemicals” (PFCs) that were used in products resistant to heat, oil, grease, and water, and which appear to be persistent in the environment. These compounds were used in a wide array of products and materials, including nonstick cookware, stain- and water-resistant fabrics, fire-suppression foams, film coatings and other consumer and commercial products.

PFCs were produced by the 3M Company (3M) at its Cottage Grove facility. Wastes from this production were disposed at the Washington County Landfill and at the Oakdale disposal site. The initial investigations focused on two specific PFCs in groundwater – perfluorooctanoic acid (PFOA) and perfluorooctane sulfonate (PFOS). Testing of monitoring wells in 2003 at the Washington County Landfill and the Oakdale disposal site identified the presence of PFOA and PFOS. In 2004, 32 private wells near the Washington County Landfill were tested for PFCs. PFOA was detected at low levels in seven wells.

In December 2004, initial sampling of the Oakdale municipal wells identified five wells showing the presence of PFOA and PFOS. Testing expanded in early 2005 to investigate private wells in Lake Elmo, south and southwest of the Washington County Landfill. Findings indicated that PFOA and PFOS had migrated far beyond the distribution of the VOC contaminant plume and the boundaries of the original SWCA.

In the spring of 2006, testing was expanded to include five additional perfluorochemicals:

- Perfluorobutane sulfonate (PFBS),
- Perfluorobutanoic acid (PFBA),
- Perfluoropentanoic acid (PFPeA),
- Perfluorohexane sulfonate (PFHxS), and
- Perfluorohexanoic acid (PFHxA).

Three of the chemicals (PFPeA, PFHxS, and PFHxA) were found in private wells that had previous detections of PFOA and PFOS. However, PFBA was detected in 204 wells that show the presence of no other PFCs. To date, 425 private wells and noncommunity public water-supply wells have been sampled and tested for PFCs. The testing results showed 92 wells with no detection of PFCs, 129 wells with multiple PFCs present, and 204 with only PFBA present. MDH advised that 151 wells should not be used for consumptive uses because of PFOS/PFOA/PFBA exceedances of the Health-Based Values (HBVs) or

well advisory guidelines or a combination of PFCs exceeding a health index of greater than or equal to one. Some of the areas impacted include the Lake Elmo Heights, Tablyn Park, Torre Pines, and Parkview neighborhoods of Lake Elmo, extending south-southwest of the Washington County Landfill. PFBAAs were also detected in a sixth Oakdale municipal well and in a recently-constructed municipal well in Lake Elmo that has not been put into service, and at very low levels in 16 Woodbury municipal wells, south of Interstate 94.

Additional testing in January-February 2007 indicated that PFBA contamination is found throughout much of southwest Washington County and part of northern Dakota County, affecting wells and public water-supply systems in Cottage Grove, Hastings, Newport, South St. Paul, and St. Paul Park. Investigations and well testing are continuing to better determine the extent and magnitude of contamination, assess source areas, and address remedial options. These findings south of Interstate 94 are not the subject of this SWBCA, but may be addressed in a future SWBCA designation.

### **RESPONSE ACTIONS**

3M provided the city of Lake Elmo with a \$3.3 million grant to extend the municipal water supply to service the Lake Elmo Heights and Tablyn Park neighborhoods. The grant is expected to cover the extension of watermains, connection of 214 homes to municipal service, and permanent sealing of the wells serving those homes. The extension of municipal water service is scheduled for completion in early 2007, at which time sealing of the private wells will occur.

In 2005, the MPCA began providing granular activated carbon (GAC) treatment for wells that exceeded the HBVs, well advisory guidelines, or had a hazard index of greater than or equal to one. Existing wells outside the area of the proposed municipal water-supply expansion are eligible for GAC treatment. The MPCA is providing bottled water until GAC treatment or an alternate water supply can be provided to these wells. New or replacement wells must meet the requirements of this SWCA.

In October 2006, the city of Oakdale began operation of a GAC filtration plant, designed to remove PFCs from water supplied by the two public water-supply wells having PFOA/PFOS concentrations exceeding HBVs. The design, construction, and operation costs were covered by 3M. During periods of high water demand, the city attempts to minimize PFC levels by careful management of use of the municipal wells.

### **SWBCA HYDROGEOLOGY**

The surficial geology of the Lake Elmo/Oakdale area consists of 50-150 feet of unconsolidated materials, comprised of glacial till deposits associated with the St. Croix Moraine. Lacustrine and wetland deposits are predominant in Oakdale, and glacial outwash is more widespread in Lake Elmo (Minnesota Geological Survey, Plate 3, 1990).

These materials are underlain by Paleozoic-era sedimentary rocks of interbedded dolostone/limestone, sandstone, and shale units (see Figure 2). These bedrock units have a slight southwesterly dip, reflecting the fact that this area is on the eastern flank of the Twin Cities Basin (Barr Engineering Company, 2005). In the northwestern corner of the SWBCA, a remnant of the Decorah shale is present, and, in fact, directly underlies the Abresch disposal site in Oakdale. The first bedrock unit underlying most of Oakdale is the Platteville limestone/Glenwood shale. Further east, these units are eroded and, progressively eastward, the St. Peter sandstone, or the Prairie du Chien group, is the first bedrock encountered beneath the surficial materials. The first bedrock underlying the Washington County Landfill is the Prairie du Chien group. A major groundwater divide bisects Washington County from north to south, with groundwater east of the divide moving eastward and discharging to the St. Croix River and groundwater west of the divide moving west-southwest towards the Mississippi River (Minnesota Geological Survey, Plate 5, 1990). The eastern boundary of the SWBCA is located just east of this divide. Within the SWBCA, groundwater flow within the drift and outwash deposits can be variable. Flow is controlled by local discharge/recharge

points, the presence of confining layers, groundwater withdrawals, and land use. For instance, the groundwater remediation system at the Washington County Landfill and the presence of bedrock with low permeability at the Oakdale disposal site create mounding conditions that produce radial flow in the local groundwater. Groundwater levels and flow directions are also influenced by recharge from losing streams (i.e., Raleigh Creek) and by natural discharge to local lakes and streams.

Regional groundwater flow in the bedrock, particularly the St. Peter sandstone and the Prairie du Chien group, is generally to the southwest. The distribution and migration of PFCs to the south – southwest reflect this groundwater flow direction. The contaminant plume is also gradually “sinking” into deeper formations and dispersing along the transport path. PFC contamination tends to be limited to the drift and St. Peter sandstone in the northern third of the SWBCA and is found in the Prairie du Chien dolomite and Jordan sandstone in the southern two-thirds of the SWBCA.

### **ENVIRONMENTAL AND PUBLIC HEALTH CONCERNS**

PFCs are synthetic chemicals that are not natural to the environment. They are found both as an ingredient in manufacturing processes and as part of some finished products. Unlike most organic compounds that tend to degrade in the environment or are adsorbed onto natural materials, PFCs are very stable compounds and appear to be resistant to environmental degradation. In addition, these compounds can be transported widely in the environment, in general, and in groundwater, in particular. Some PFCs (primarily PFOA and PFOS) have been found to bioaccumulate (MDH, 2005). Because of these characteristics, uses of groundwater for purposes other than drinking, such as irrigation and other nonconsumptive uses, may also be of concern.

PFCs are a relatively new family of environmental contaminants and there are limited numbers of studies of health effects in people. In animal studies, high concentrations of PFCs harm the liver and thyroid. Developmental problems have been seen in the offspring of rats and mice exposed to PFCs while pregnant. Studies of 3M workers exposed to PFOS and PFOA during manufacturing show no apparent impacts to their health. There is no similar health study information for the general population. However, the U.S. EPA and other researchers are investigating the potential health effects on the general population and on other populations who are exposed to PFCs in their drinking water.

On March 1, 2007, the MDH issued revised HBVs, which are 0.5 micrograms/liter ( $\mu\text{g/L}$ ) for PFOA and 0.3  $\mu\text{g/L}$  for PFOS. A HBV is the concentration of a groundwater contaminant, or mixture of contaminants, that poses little or no risk to health, even if consumed over a lifetime. The MDH also recommends that consumers limit or reduce their intake of water that has a concentration of PFBA exceeding 1  $\mu\text{g/L}$ . The MDH continues to evaluate toxicity data in order to calculate a HBV for PFBA in the future. (Editors note: a HBV for PFBA was established on February 20, 2008 at 7  $\mu\text{g/L}$ )

### **BOUNDARIES OF THE SPECIAL WELL AND BORING CONSTRUCTION AREA**

The boundaries of the SWBCA, as revised in 1983, were as follows:

- Northern boundary of Lake Jane Hills Park, and west following an irregular boundary of Ivy Court North to Isle Avenue North.
- The alignment of Isle Avenue North to approximately 37th Avenue North, then west to the alignment of Irvin Circle North, then south to Highway 5.
- Highway 5 on the south, between Iris Avenue North and the midpoint of Section 15 (immediately east of intersection with 31st Street North).
- The north-south centerline of Section 15 and that part of Section 10 to the north boundary of Lake Jane Hills Park.



The boundaries of the SWBCA as revised in March 2007 are shown on the attached map (Figure 1). Encompassing the area described above, the revised SWBCA includes the following:

- Ramsey-Washington County line on the west (County Road 120, also known as Century Avenue or Geneva Avenue).
- Interstate 94 on the south, from county line to Lake Elmo Avenue.
- Lake Elmo Avenue on the east, extending from Interstate 94 to Highway 5 (Stillwater Boulevard North in Lake Elmo, 34th Street North in Oakdale) and, then, to 47th Street North.
- 47th Street North-Lake Jane Trail to Ideal Avenue North on the north, then southward to Highway 5, then westward to Ramsey-Washington County line.
- The area between Granada Avenue North and Hadley Avenue North, north of Highway 5 and south of 35th Street North.

The SWCA includes all of Sections 14-16, 19-23 and 26-35 and portions of Sections 9 – 11, 13, 17-18, and 24 of Township 29 North, Range 21 West.

### **REQUIREMENTS OF THE SPECIAL WELL AND BORING CONSTRUCTION AREA**

1. All wells and borings regulated by the MDH are subject to the requirements of this SWBCA. Wells include water-supply wells (domestic, public irrigation, commercial/industrial, cooling/heating, remedial, monitoring wells, and dewatering wells). Borings include environmental bore holes, elevator borings, and vertical heat exchangers. Notifications and permit applications, and their respective fees, must be submitted to the MDH.
2. Construction of a new well or boring, or modification of an existing well or boring, may not occur until plans have been reviewed and approved in writing by MDH. In addition to the normally required notification or permit application and fee, the plan must include the following information: street address; well or boring depth; casing type(s), diameter(s), and depth(s) for each casing; construction method(s), including grout materials and grouting methods; anticipated pumping rate; and use.
3. As a condition of the well construction plan approval, the well owner must agree to pay for a PFC analysis of the water, to be performed by the MDH Public Health Laboratory. Copies of analytical results will be forwarded to the well owner, the MPCA, Washington County Department of Public Health and Environment, and the city of Lake Elmo (or Oakdale). The MDH will review the analytical results and determine if the well can be completed, if the well must be drilled deeper, or if the well must be permanently sealed.
4. Special well construction and/or monitoring requirements may be imposed on a well/boring completion, location and use in order to protect the public health and groundwater quality and to prevent contaminant migration. These requirements will be based on available knowledge of groundwater contaminant movement near the well location and the proposed use and pumping rate of the well.
5. No potable water-supply wells may be completed in areas served by a community public water-supply system. The city of Lake Elmo has indicated that future new developments must be served by a community public water-supply system. For areas not served by a community system, potable water-supply wells may be allowed serving individual lots within already existing developments or replacing existing wells that go out of service. Potable water-supply wells may not be completed within the Platteville limestone, St. Peter sandstone, Prairie du Chien group, or Jordan sandstone without approval on a site-specific basis. For purposes of this SWBCA, “potable use” includes any consumptive or other uses involving human contact, including drinking, cooking, bathing, recreation, manufacturing or processing of food, drink, or pharmaceuticals, or to supply water to fixtures accessible to humans.

6. Potable wells completed in the Franconia sandstone or Ironton-Galesville sandstones will be permitted throughout the SWBCA. However, these wells must be cased and grouted through the full thickness of the St. Lawrence formation. Casing and grout must extend from at least 20 feet below the St. Lawrence formation to the surface.
7. Approval of plans and specifications for construction of a community public water-supply well and of the well site is required by Minnesota Rules, part 4725.5850. The MDH may approve completion of a public water-supply well within the designated SWBCA if the system owner/operator can demonstrate that the water delivered to the distribution system meets Maximum Contaminant Levels (MCLs) established by the U.S. EPA or other health guidelines referenced by the MDH, either through treatment, blending with other sources, monitoring, or other mechanisms.
8. A well completed in one of the geologic formations named in item 5 and used for a nonpotable purpose, such as groundwater quality monitoring or construction dewatering, may be allowed, provided that the MDH and the MPCA determine that the well will not interfere with remediation efforts, cause further spread of contamination, or result in environmental or human exposures in excess of public health and environmental standards.
9. No well or boring in bedrock may be permanently sealed until the MDH has reviewed and approved the plans for the proposed sealing. In addition to the required notification and fee, the plan must include the following information: street address; original well/boring depth; current well/boring depth (if different); casing type(s), diameter(s), and depth(s); methods of identifying and sealing any open annular space(s); methods for identifying and removing any obstruction(s); grout materials and placement methods.
10. All other provisions of Minnesota Rules, Chapter 4725, are in effect.

#### **WELL DISCLOSURE IN WASHINGTON COUNTY**

Before signing an agreement to sell or transfer real property in Washington County that is not served by a municipal water system or is served by a municipal water system but has an unsealed well, Minnesota Statutes, section 103I.236, requires the seller to state in writing to the buyer whether, to the seller's knowledge, the property is located within a SWBCA. Figure 1, details the Lake Elmo – Oakdale SWBCA. This disclosure is in addition to the disclosure of the number, location, and status (in use, not in use, or sealed) of all wells on a property as required for all property transfers in Minnesota, as required under Minnesota Statutes, section 103I.235.

#### **PERSONS TO CONTACT**

For additional information regarding this SWBCA, please contact Michael Convery of the MDH at 651-201-4586 or [michael.convery@state.mn.us](mailto:michael.convery@state.mn.us).

Plans for construction, repair, or sealing of wells and borings within the SWCA must be submitted to:

Patrick Sarafolean  
Minnesota Department of Health  
Well Management Section – Metro District  
P.O. Box 64975  
St. Paul, Minnesota 55164-0975  
651-201-3962  
[patrick.sarafolean@state.mn.us](mailto:patrick.sarafolean@state.mn.us)

Notifications/permit applications for either construction or sealing of wells and borings must still be mailed or faxed to the MDH Well Management Section central office at:

Minnesota Department of Health  
Well Management Section  
P.O. Box 64502  
St. Paul, Minnesota 55164-0502  
651-201-4600  
Fax: 651-201-4599

For information regarding public health concerns, please contact:

Virginia Yingling  
Minnesota Department of Health  
Site Assessment and Consultation Unit  
P.O. Box 64975  
St. Paul, Minnesota 55164-0975  
651-201-4910/651-201-4930  
*virginia.yingling@state.mn.us*

For information regarding the investigation, monitoring, and remediation of the ground water contamination, please contact:

Ingrid Verhagen/Shawn Ruotsinoja  
Minnesota Pollution Control Agency  
651-757-2800/651-757-2683  
*ingrid.verhagen@state.mn.us/shawn.ruotsinoja@state.mn.us*

# LAKE ELMO/OAKDALE SPECIAL WELL AND BORING CONSTRUCTION AREA MAP

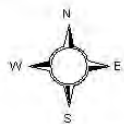
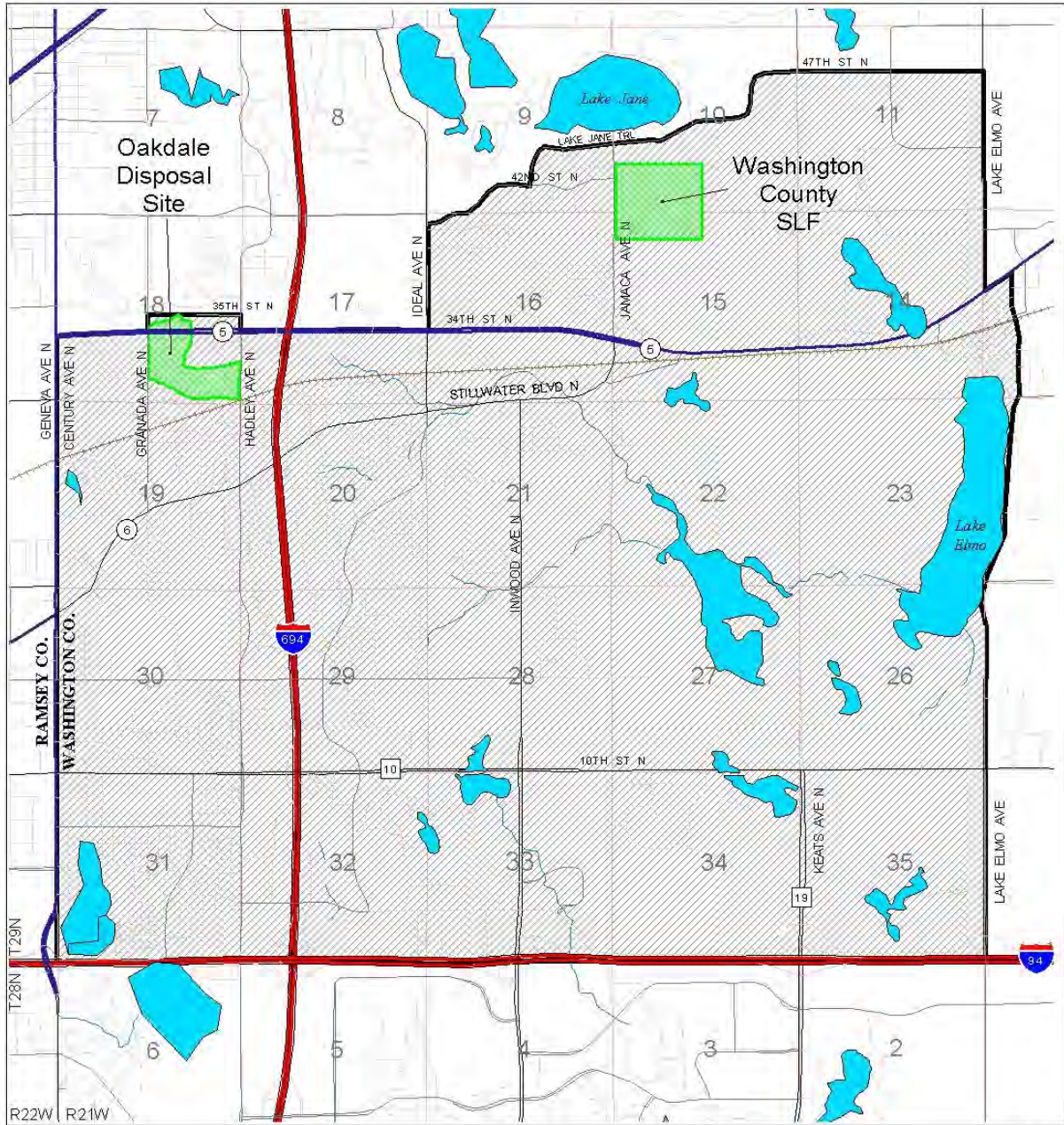

  
Special Well  
Construction Area

2 Jan 07 Minnesota Department of Health - Well Management Section

## **LAKELAND/LAKELAND SHORES/AFTON/WEST LAKELAND TOWNSHIP SPECIAL WELL AND BORING CONSTRUCTION AREA**

### **SUMMARY**

Date SWBCA Issued: December 16, 1987  
SWBCA Size: Approximately 3-1/2 square Miles  
Location: Lakeland, Lakeland Shores, Afton, West Lakeland Township,  
Washington County  
Major Contaminants: Petroleum Products (benzene, 1,2-dichloroethane), fluorocarbons, and solvents  
(trichloroethylene (TCE), tetrachloroethylene, and cis-1,2-dichloroethylene).  
Aquifers Affected: Alluvium, Glacial Sediments, Prairie du Chien, Jordan, Franconia

A Well Advisory (now a SWBCA) was issued on December 16, 1987, for portions of Lakeland, Lakeland Shores, Afton, and West Lakeland Township, Washington County, due to Volatile Organic Chemical contamination of groundwater and water-supply wells.

### **SITE HYDROGEOLOGY**

The site geology consists of thin glacial drift over the Prairie du Chien at the western boundary of the area, to approximately 100 feet of alluvium over the Franconia, Ironton-Galesville, or Eau Claire near the St. Croix River. The contamination is largely confined to the alluvium. However, contaminants have been detected in the Prairie du Chien, Jordan, and Franconia. The groundwater flow direction is to the east and southeast toward the St. Croix River.

### **CONTAMINATION**

Groundwater quality monitoring of over 400 private wells has indicated the presence of a variety of volatile organic compounds (VOCs). Contaminants have been found in 193 wells: in 102 of these wells, the levels of one or more of the VOCs exceeded the levels that are considered safe to drink. Residents in these homes were initially provided with bottled water, and have now been connected to a municipal water system with Mt. Simon wells. Private wells have been sealed

At least two sources and plumes are suspected. A northern petroleum and fluorocarbon (freon-like chemicals) plume contains benzene up to 360 ug/L, as well as 1,2-dichloroethane, trichlorofluoromethane, and 1,2-dibromomethane thought to originate from a former gas station/truck stop. A southern plume of multiple solvents including trichloroethylene (TCE), tetrachloroethylene, and cis-1,2-dichloroethylene is thought to originate from indiscriminate dumping and/or industrial waste disposal.

### **BOUNDARIES OF THE SPECIAL WELL AND BORING CONSTRUCTION AREA**

The SWBCA now includes parts of Sections 33, 34, and 35 in T29N, R20W, and parts of Sections 2, 3, and 4 in T28N, R20W. The area is bounded on the north by Interstate 94, on the east by the St. Croix River, on the south by a line through the center of Sections 2, 3 and 4, and on the west by the western boundary of Section 4. The SWBCA is approximately 3½ square miles in size.

### **REQUIREMENTS IN THE SWBCA**

The SWBCA prohibits the deepening of existing wells into lower bedrock formations or the drilling of new wells into lower bedrock formations. The SWBCA requires plan approval before the construction of new water-supply wells in drift or shallow bedrock aquifers.

## **PERSONS TO CONTACT**

### Minnesota Department of Health

For information regarding plan review, well construction and well sealing, or water sampling contact:

Patrick Sarafolean  
Well Management Section  
P.O. Box 64975  
St. Paul, Minnesota 55164-0975  
651-201-3962  
*patrick.sarafolean@state.mn.us*

### Minnesota Pollution Control Agency

For information regarding monitoring, remediation, or contamination:

Mark Rys  
Policy, Local Government Assistance, & Solid Waste Section  
520 Lafayette Road  
St. Paul, Minnesota 55155  
651-757-2685  
*mark.rys@state.mn.u*

**LAKELAND/LAKELAND SHORES/AFTON/WEST LAKELAND TOWNSHIP  
SPECIAL WELL AND BORING CONSTRUCTION AREA MAP**

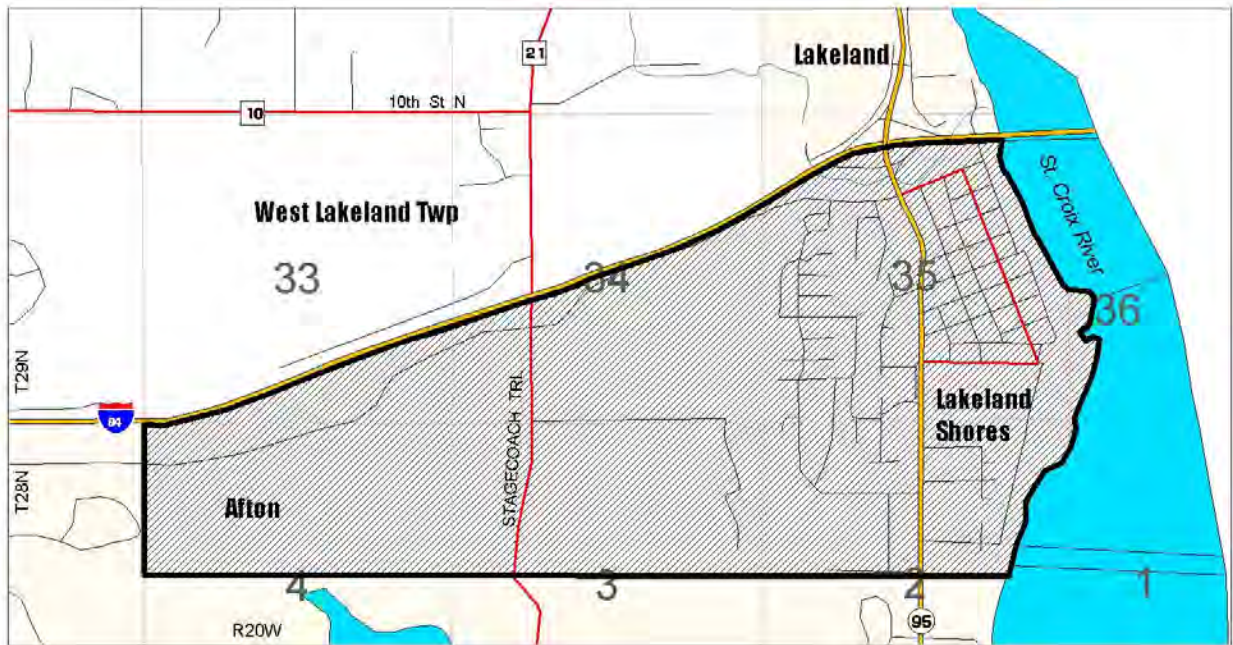

Rev. 2 May 05

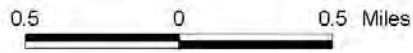

Minnesota Department of Health - Well Management Section

Special Well  
Construction Area



## **LEHILLIER SPECIAL WELL AND BORING CONSTRUCTION AREA**

### **SUMMARY**

Date SWBCA Issued: December 8, 1981  
SWBCA Size: Approximately 1/2 Square Mile  
Location: Lehillier, Blue Earth County  
Major contaminants: Multiple VOC's, with Trichloroethylene Predominating  
Aquifers Affected: Alluvium, Glacial Sediments, Franconia

LeHillier is a small community just west of Mankato in Blue Earth County near the confluence of the Blue Earth and Minnesota Rivers. In 1981, there was no central water-supply or sewage system serving the city. Most of the 200 homes in the area were supplied by individual shallow wells, or drive-point wells driven to approximately 30 feet in depth. A few homes had wells cased to the St. Lawrence confining layer with open-hole construction into the Franconia or Ironton aquifer.

### **SITE HYDROGEOLOGY**

The geology of the area consists of approximately 60 feet of alluvium over the St. Lawrence or Franconia formation. Most contamination is in the alluvium; however the Franconia has been affected. The unconfined water level is near the land surface. Groundwater flow is predominately to the east, towards the Blue Earth River, but is also affected by the Minnesota River, and may be reversed during flood events.

### **CONTAMINATION**

In 1981, following a tip on the MPCA "hotline" about dumping of hazardous wastes, groundwater contamination was verified. Major contaminants detected in the drift and alluvium as well as some bedrock wells were nitrate and various volatile organic chemicals (VOCs), primarily trichloroethylene, which exceeded 300 ug/L in some wells, along with 1,1-dichloroethane, 1,2-dichloroethane, trans-1,2-dichloroethane, 1,1,1-trichloroethane, and 1,1,2,2-tetrachloroethane. Approximately 60 residential wells were affected.

The MPCA initiated several superfund studies for identifying the source of the contamination and furnishing the residents of the area a safe water-supply. The responsible parties and exact disposal locations have not been specifically identified. LeHillier received a grant, and in 1985 constructed the first Mt. Simon well and began construction of a community water system that now serves the residents. A central sewage collection and treatment facility has been proposed but not constructed. A program was implemented to seal multi-aquifer wells to prevent further contamination of the Franconia-Ironton-Galesville aquifer.

A remedial study was completed, and a groundwater treatment system (air stripper) installed in 1989 and shut down in 1997. Pump-out control wells were installed and operated, but have not been used for a few years. The site remains on the Federal Superfund list. Trichloroethylene concentrations have generally decreased over time.

### **BOUNDARIES OF THE SWBCA**

On December 8, 1981 a well advisory (now a SWBCA) was established for the area bounded by the Blue Earth River on the east, north, and south, and East Hawley Street on the west, in parts of Sections 14 and 23 of T108N, R22W, Blue Earth County. The SWBCA is slightly less than 1/2 square mile in size.



## **REQUIREMENTS IN THE SWBCA**

The advisory explained that residents with elevated levels of trichloroethylene had been advised to use alternate drinking water sources, and that the MDH was not advising that contaminated wells be deepened or that new deeper wells be constructed until the source, extent, nature and hydraulics of the contamination was known.

## **PERSONS TO CONTACT**

### Minnesota Department of Health

For information regarding plan review, well construction and well sealing, or water sampling contact:

Chris De Mattos  
Well Management Section  
18 Wood Lake Drive Southeast  
Rochester, Minnesota 55904  
507-206-2722  
*chris.demattos@state.mn.us*

Peter Zimmerman  
Well Management Section  
18 Wood Lake Drive Southeast  
Rochester, Minnesota 55904  
507-206-2737  
*peter.zimmerman@state.mn.us*

### Minnesota Pollution Control Agency

For information regarding contamination investigation and remediation contact:

Nile Fellows  
Superfund & Emergency Response Section  
520 Lafayette Road  
St. Paul, Minnesota 55155  
651/757-2352  
*nile.fellows@state.mn.us*

# LEHILLIER SPECIAL WELL AND BORING CONSTRUCTION AREA MAP

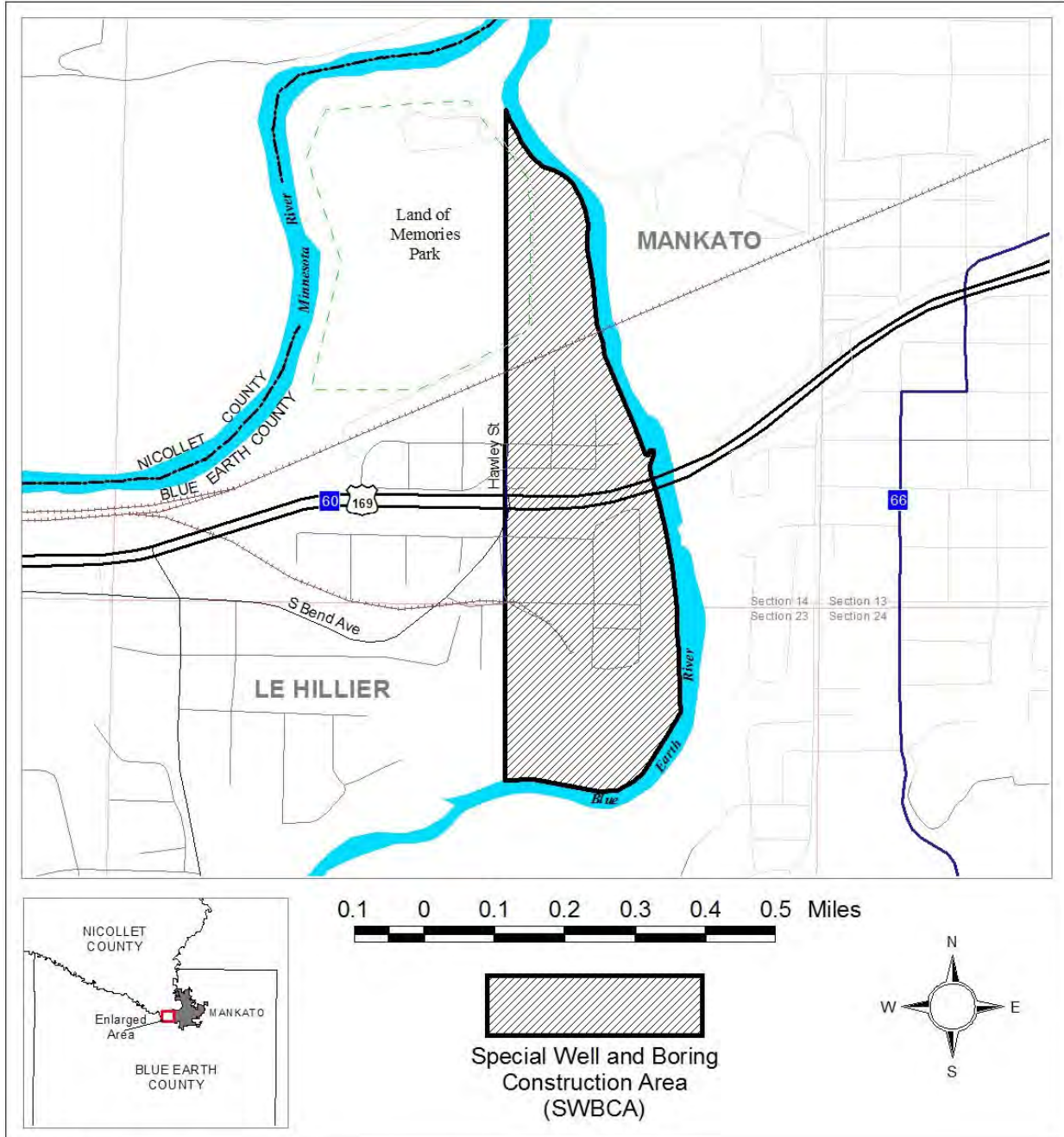

Minnesota Department of Health - Well Management Section  
 January 15, 2010  
 lehillier swbca.apr

## **LONG PRAIRIE SPECIAL WELL AND BORING CONSTRUCTION AREA**

### **SUMMARY**

Date SWBCA: Issued: January 1, 2007  
SWBCA Size: Approximately 3/4 Square Mile  
Location: Long Prairie, Todd County  
Major Contaminants: Tetrachloroethylene and Degradation Products including Chlorinated Ethylenes and Vinyl Chloride  
Aquifers Affected: Upper Outwash Aquifer

### **SITE HISTORY**

During 1983, the MDH sampled five municipal wells serving the Long Prairie community public water supply and analyzed the samples for volatile organic chemicals (VOC's). Results indicated the presence of tetrachloroethene and a variety of degradation products (chlorinated ethenes and vinyl chloride) in two municipal wells (Number 4 and Number 5) in northeastern Long Prairie. Subsequent testing of private wells and other hydrogeologic investigations delineated a plume of tetrachloroethene-contaminated groundwater extending approximately 4000 feet from a former dry cleaning site northeast to the two former municipal wells and further northwest towards the Long Prairie River.

In addition to the two municipal wells, approximately 200 private wells, all completed in the upper outwash sand aquifer, were impacted. In 1983-84, the municipal water supply was extended into the 15 square block area originally identified in the area potentially impacted. In 1994, contamination was found to have spread beyond this original area and municipal water was further expanded to serve this area. In 1996, a groundwater recovery system using granular activated carbon (GAC) for treatment began operation in an effort to restore groundwater quality and to prevent spread of contamination to Municipal Wells 3 and 6. Currently, six recovery wells are operating. The MPCA also installed and operated a soil venting system in the source area during 1997-99. Cleanup goals were achieved for the soils and the system was dismantled in 2000 (Johnson, M. and Gnabasiak, B., 2004).

### **SITE HYDROGEOLOGY**

The Long Prairie River is located within a glacial outwash/alluvium valley, which has cut into an upper, clay-rich glacial till unit. Within the outwash channel, the upper aquifer is generally separated from a deeper outwash sand by remnants of till on the order of 10-20 feet thick, thought to be remnants of Wadena Lobe till. A lower outwash unit and lower till unit underlie the upper till. In the central part of the valley, the upper outwash extends completely through the upper till (see Figure 2). The upper outwash/alluvium aquifer extends to a maximum depth of 66 feet within the SWBCA, but pinches out towards the edge of the valley and the upper glacial till unit. The lower outwash unit appears to be much more extensive laterally and may approach 120 feet thick near Lake Charlotte, south of the city of Long Prairie (MDH 2006, page 7).

Both aquifer units consist of relatively coarse sand and gravel. The upper outwash aquifer is a very productive aquifer with excellent yield. Static water levels in the upper outwash range in depth from 3 to 22 feet. Many private wells within the SWBCA are simply drive-point (sand-point) wells. Aquifer sensitivity for the upper aquifer is moderate to high and is moderate for the lower outwash aquifer. Wells completed in these aquifers are considered vulnerable to contamination, as reflected in the relatively high tritium levels found in Municipal Wells 6 and 7, indicating relatively young water (MDH 2006, page 18).

Although groundwater flow is probably normally to the west-northwest, discharging towards the Long Prairie River, withdrawals from the former municipal wells, the currently active municipal wells, and, more recently, the remediation wells have resulted in a complex groundwater flow pattern. The orientation of the contaminant plume may, in fact, be the best reflection of historic groundwater flow patterns due to the influences of varying pumping patterns over time (Terracon 2003, figures 2, 5A, 5B, and 5C). Variations in the character of the upper outwash aquifer may also contribute to the complex flow pattern.

### **PUBLIC HEALTH CONCERNS**

The primary contaminant of concern is tetrachloroethene, which is a solvent used in high-quality printing and dry cleaning. The source of contamination is a former dry cleaner located in the downtown area of the city of Long Prairie. Associated contaminants include a number of degradation/dechlorination products or impurities, including cis-1,2-dichloroethene, trans-1,2-dichloroethene, 1,1-dichloroethane, 1,1-dichloroethene, 1,1,2-trichloroethene, and vinyl chloride.

Tetrachloroethene, as well as some of its degradation products (e.g., trans-1,2-dichloroethene and trichloroethene), have been shown to have hepatotoxicity or renal toxicity in laboratory animals. The Health Risk Limit (HRL) for tetrachloroethene is 7 µg/L. In addition, some degradation products are known (vinyl chloride) or probable (trichloroethene) human carcinogens.

### **BOUNDARIES OF THE SPECIAL WELL AND BORING CONSTRUCTION AREA**

The location of the SWBCA is shown on the following map (Figure 1). This area is bounded on the north by a line beginning at the intersection of County Road 5 and Ninth Street Northeast and extending due west to the Long Prairie River (the city of Long Prairie boundary), Ninth Street Northeast/Ninth Street Southeast on the east, Second Avenue Southeast on the south, and the Long Prairie River and State Aid Highway 71 on the west. The SWBCA is within the limits of the city of Long Prairie and is within the west half of the southwest quarter of Section 16, the southeast quarter of Section 17 (that portion east of the Long Prairie River), the northeast quarter of Section 20, and the west half of the northwest quarter of Section 21 of Township 129 North, Range 33 West, Todd County.

### **REQUIREMENTS OF THE SPECIAL WELL AND BORING CONSTRUCTION AREA**

1. All wells and borings regulated by the MDH are subject to the requirements of this SWBCA. These include water-supply wells (domestic, public, irrigation, commercial/industrial, heating/cooling, remedial), monitoring wells, and dewatering wells. Borings include environmental bore holes, elevators, and vertical heat exchangers. Notifications/permit applications and plans for wells must be submitted to the MDH.
2. Construction of a new well or boring, or modification of the depth or casing of an existing well, may not start until plans have been reviewed and approved, in writing, by the MDH. In addition to the normally required notification of permit application, the plan must include the following information: street address; well depth; casing type, diameter(s), and depth; construction method, including grout materials and grout method; pumping rate; and well use.
3. Special well construction and/or monitoring requirements may be imposed depending on well location and use in order to protect public health and groundwater quality and to prevent contaminant migration. These requirements will be based on available knowledge of groundwater contamination and movement near the well site and the proposed use and pumping rate of the well.

4. Water-supply wells will not be approved for completion in the upper outwash unit and the lower outwash unit in the SWBCA for any consumptive or potable uses, including drinking, cooking, or processing of food, drink, or pharmaceuticals, or to supply water to plumbing fixtures available for human consumption. Completion of a potable water-supply well into a deeper aquifer may be considered.
5. A well or boring used for nonpotable purposes may be completed into the upper outwash unit or the lower outwash unit anywhere within the SWBCA, provided that the MDH and the MPCA determine the use of the well will not interfere with remediation efforts, cause further spread of contamination, or result in human exposure to contaminants at concentrations exceeding HRLs or other relevant public health standard.
6. The permanent sealing of a well or boring may not occur until MDH has received, reviewed, and approved (in writing) the plans for the proposed sealing. In addition to the required notification, the plan must include the following information: street address; original well/boring depth; current well/boring depth (if different); casing type(s), diameter(s), depth(s); methods of identifying and sealing any open annular space(s); methods of identifying and removing any obstructions; grout materials and sealing methods.
7. Contractors must contact the MDH St. Cloud district office by phone at least 24 hours and one business day (Monday – Friday) prior to the start of drilling a new well or boring, modification of an existing well or boring, or sealing of a well or boring.
8. All provisions of Minnesota Rules, Chapter 4725, are in effect.

## **PERSONS TO CONTACT**

For additional information regarding this SWCA, please contact:

Michael Convery, P.G.  
Minnesota Department of Health  
Well Management Section  
P.O. Box 64975  
St. Paul, Minnesota 55164-0975  
651-201-4586  
*michael.convery@state.mn.us*

Plans for construction, modification, or sealing of wells and borings within the SWCA must be submitted to:

Curtis Wunderlich  
Minnesota Department of Health  
St. Cloud District Office  
Midtown Square, Suite 212  
3333 West Division Street  
St. Cloud, Minnesota 56303-4000  
320-223-7329  
*curtis.wunderlich@state.mn.us*

Notifications and permit applications for the construction, modification, or sealing of wells and borings must still be faxed or mail to:

Minnesota Department of Health  
Well Management Section  
P.O. Box 64502  
St. Paul, Minnesota 55164-0502  
651-201-4600  
Fax: 651-201-4599

For information regarding health effects, please contact:

Carl Herbrandson  
Minnesota Department of Health  
Site Assessment and Consultation Unit  
P.O. Box 64975  
St. Paul, Minnesota 55164-0975  
651-201-4906  
*carl.herbrandson@state.mn.us*

For information regarding the investigation, monitoring, and remediation of the Long Prairie groundwater contamination site, please contact:

Nile Fellows  
Superfund Unit 1  
Superfund & Emergency Response  
Remediation Division  
Minnesota Pollution Control Agency  
520 Lafayette Road North  
St. Paul, Minnesota 55155-4194  
651-757-2352  
*nile.fellows@state.mn.us*

Barbara Gnabasik  
Superfund Unit 3  
Superfund & Emergency Response  
Remediation Division  
Minnesota Pollution Control Agency  
525 Lake Avenue South, Suite 400  
Duluth, Minnesota 55802  
218-529-6266  
*barb.gnabasik@state.mn.us*

## **REFERENCES**

Johnson, M., and Gnabasik, B., 2004, Memorandum – Request for Establishing a Special Well Construction Area at the Long Prairie Ground Water Contamination Site, 12p.

Minnesota Department of Health, 2006, Wellhead Protection Plan for the City of Long Prairie, 44p.

Terracon, Inc., 2004, 2003 Annual Monitoring Report, Long Prairie Ground Water Remediation System.

**LONG PRAIRIE  
SPECIAL WELL AND BORING CONSTRUCTION AREA  
MAP**

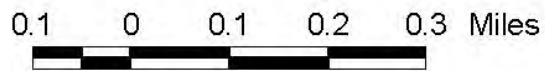
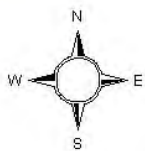
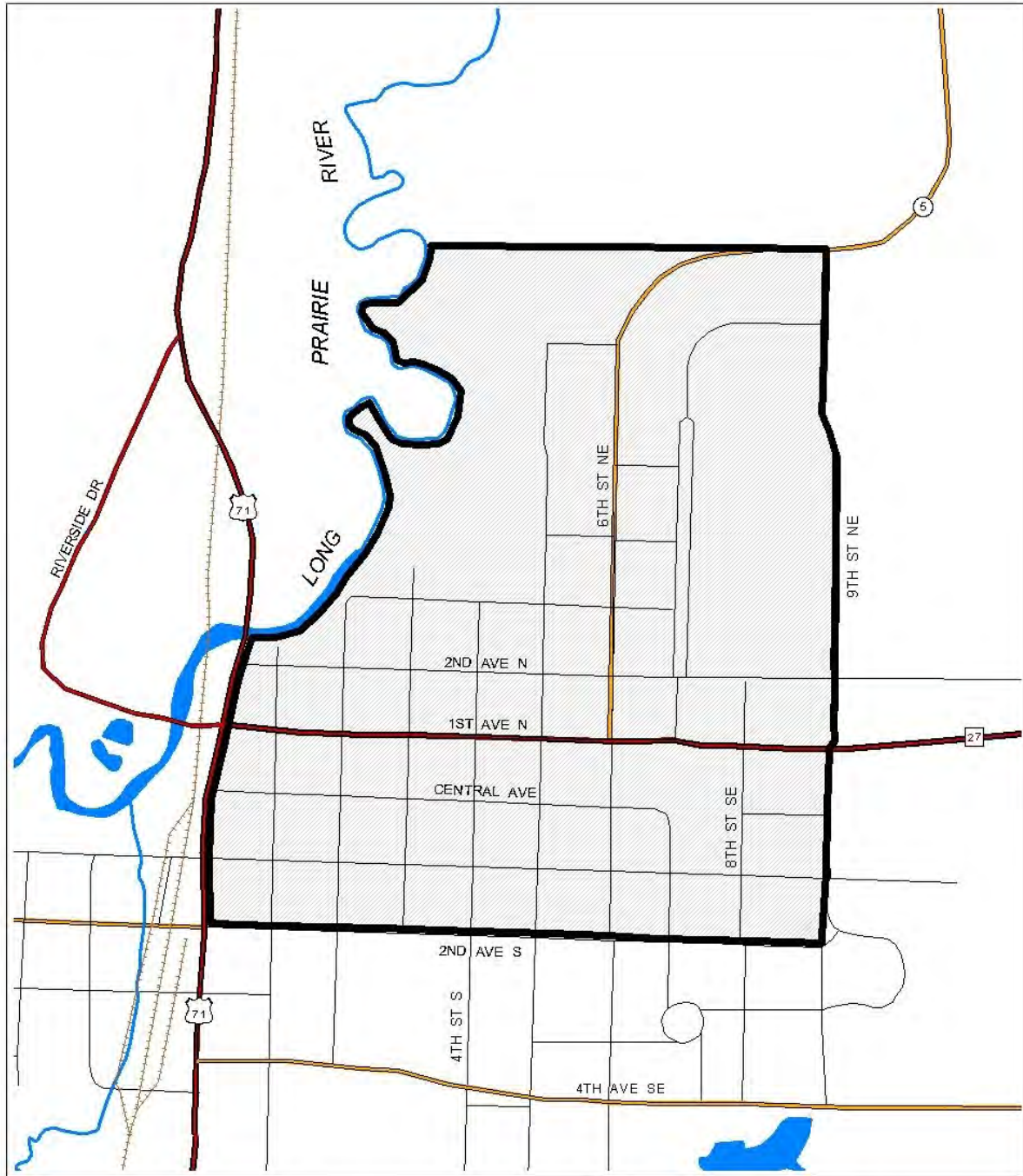

  
Special Well  
Construction Area

## **NORTHERN TOWNSHIP SPECIAL WELL AND BORING CONSTRUCTION AREA**

### **SUMMARY**

Date SWBCA Issued: August 12, 1991  
SWBCA Size: Approximately 2 Square Miles  
Location: Northern Township, Beltrami County  
Major Contaminants: Multiple VOC's, Predominately Tetrachloroethene and Vinyl Chloride  
Aquifers affected: Glacial Sediments

The Kummer Landfill received a permit to accept mixed municipal waste in 1971. The landfill operated until 1985 and accepted approximately 750,000 cubic yards of waste. A Well Advisory (now a SWBCA) was issued on August 12, 1991, for an area in portions of Northern Township, Beltrami County, near the Kummer landfill.

### **SITE HDROGEOLOGY**

The geology of the site consists of a fine sand layer to approximately 20 feet, discontinuous sand and gravel lenses, and silt or clay lenses at depths of approximately 30 to 45 feet. These lenses act locally as confining layers. To the east of the landfill the groundwater gradient is towards the land surface. Contaminants appear to be limited to the upper 60 feet. The water table is at a depth of approximately 18 to 20 feet. The general groundwater flow direction and contaminant plume movement is east toward lake Bemidji.

### **CONTAMINATION**

The surficial aquifer within much of the SWBCA area has been contaminated with leachate from Kummer Sanitary Landfill. The Kummer landfill was listed on the U.S. EPA National Priorities List (Superfund). In 1982 and 1983, contamination was found in residential wells to the southeast of the site. Most of the contaminants are volatile organic chemicals including tetrachloroethene, vinyl chloride, benzene, trichloroethylene, and trans 1,2-dichloroethene. Vinyl chloride is the predominant compound of concern.

An alternative water-supply (connection to a municipal distribution system) has been provided for residents of the area with contaminated groundwater.

### **BOUNDARIES OF THE SPECIAL WELL AND BORING CONSTRUCTION AREA**

The SWBCA is bounded on the north by Fern Street and the section line between Sections 28 and 33. The southern boundary is defined by Rose Street and a line running due west from Rose Street to the North County Hospital, 34th Street Northwest, and a line extending due east from 34th Street Northwest to Lake Bemidji. The eastern boundary is defined by Lake Bemidji. The western boundary is defined by a north-south line set 500 feet to the west of Greenleaf Avenue Northwest.

### **REQUIREMENTS IN THE SPECIAL WELL AND BORING CONSTRUCTION AREA**

1. Within the SWBCA, the deepening of existing wells or the construction of any new types of wells is prohibited until further notice. This ban includes the installation of shallow sand-point wells. The shallow wells are of particular concern because of the majority of the known contamination exists within the shallow aquifers (less than 40 feet in depth).
2. SPECIAL WELL AND BORING CONSTRUCTION AREA – Wells other than domestic water wells, such as dewatering wells for construction purposes, will be considered on an individual basis and, if allowed, will require a variance from the MDH.



3. It is recommended that the MDH be contacted before the construction of any large capacity wells within one mile of the SWBCA boundaries. These are wells with a drawdown capacity that could significantly alter the existing groundwater flow patterns. Examples of such wells are municipal, industrial, or dewatering wells. These wells usually require a groundwater appropriation permit from the Minnesota Department of Natural Resources (DNR).
4. Within the SWBCA, any wells other than monitoring wells, with water found to currently contain, or have in the past, contained contamination levels exceeding the Health Risk Limits (HRLs) must be permanently sealed by a licensed contractor.
5. Within the SWBCA, all wells located west of Tamarack Avenue Northwest and west of the line running due north of Tamarack Avenue Northwest must be sealed unless it can be shown that the levels of contamination do not exceed MDH health risk limits (HRLs).
6. In the event of the sale of any property, or any other type of property title transfer within the entire SWBCA, if there is an existing well on the property, the well water must be tested for VOCs. If levels of contamination are found that exceed HRLs, the well must be permanently sealed by a licensed contractor.
7. In the future, the restrictions and boundaries of this SWBCA may change. This would be based on the extent of changes in contamination levels and flow directions of the contaminant plume. The indicator chemicals chosen for study in this area include tetrachloroethene, trichloroethene, trans-1,2-dichloroethene, vinyl chloride, and benzene. Tetrachloroethene and vinyl chloride have already been found at levels exceeding the MDH HRLs in several wells, and are the most commonly found contaminants.

## **PERSONS TO CONTACT**

### Minnesota Department of Health

For additional information concerning the SWBCA contact:

Mark Malmanger  
Well Management Section  
705 Fifth Street Northwest, Suite A  
Bemidji, Minnesota 56601  
218-308-2118  
*mark.malmanger@state.mn.us*

### Minnesota Pollution Control Agency

For information regarding contamination investigation and remediation contact:

Kate Rolf  
Petroleum & Closed Landfill Section  
714 Lake Ave., Suite 220  
Detroit Lakes, Minnesota 56501  
218-846-0774  
*kate.rolf@state.mn.us*

# NORTHERN TOWNSHIP SPECIAL WELL AND BORING CONSTRUCTION AREA MAP

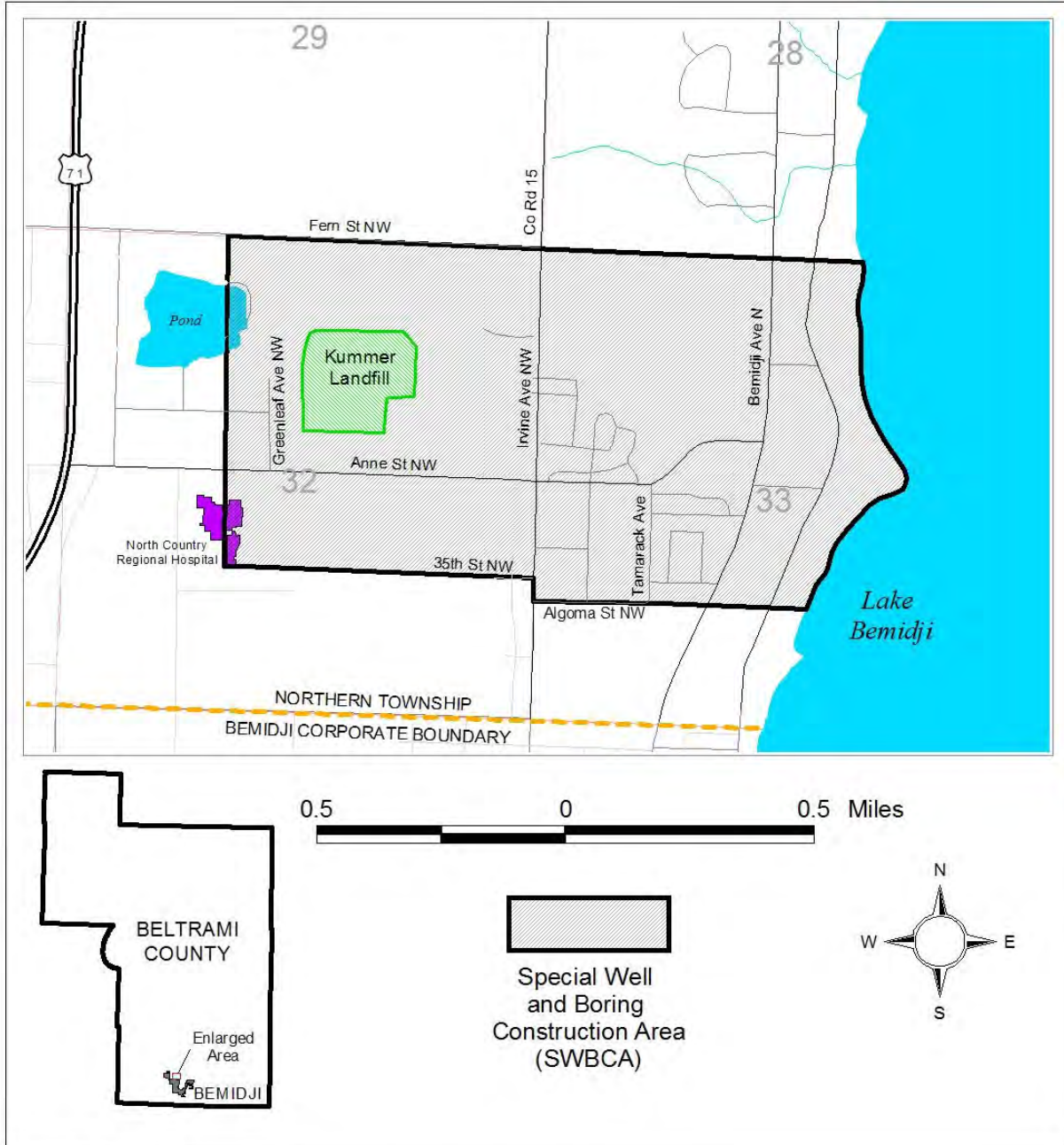

Minnesota Department of Health - Well Management Section  
January 15, 2010  
northern twp kummer map 2010.apr

## **PERHAM ARSENIC SITE SPECIAL WELL AND BORING CONSTRUCTION AREA**

### **SUMMARY**

Date SWBCA Issued: February 15, 2007  
SWBCA Size: Approximately 1 Square Mile  
Location: Perham, Otter Tail County  
Major Contaminants: Arsenic  
Aquifers Affected: Surficial Sand

The MDH has designated a Special Well and Boring Construction Area (SWBCA) that includes a portion of the city of Perham and areas east and southeast of Perham, in Otter Tail County, as shown in the following map (Figure 1). The SWCA designation, which became effective on February 15, 2007, applies to the construction, repair, and sealing of all regulated wells and borings and will remain in effect until further notice.

### **SITE HISTORY**

During the 1930's and 1940's, the U.S. Department of Agriculture distributed arsenical pesticides to counties in Minnesota in order to combat grasshopper infestations. Technical grade arsenic was mixed with sawdust and molasses to produce "grasshopper bait," which was then spread in agricultural fields. The East Otter Tail County fairground was a mixing site for preparing the bait. In 1947, lead arsenate and unused grasshopper bait were buried in a shallow pit (in an area 10 feet by 20 feet, 3 to 6 feet deep) in the southeast corner of the fairgrounds. An estimated 50 pounds of technical-grade arsenic was buried in the pit (MPCA, 1998).

In 1972, Hammer's Construction Company constructed an office/warehouse facility immediately south of the pit and installed a water-supply well that was 31 feet deep. Thirteen employees were exposed to high levels of arsenic in the well water used for drinking. Five employees developed gastrointestinal problems, with three also showing symptoms of neuropathy requiring medical treatment. Five of the remaining eight showed elevated arsenic levels in scalp hair samples. Arsenic levels in the water-supply well reached 11,800 micrograms/liter ( $\mu\text{g/L}$ ) (USDHHS, 1999). For comparison, the Maximum Contaminant Level (MCL) for arsenic in drinking water served by a public water system was 50  $\mu\text{g/L}$  at that time. Effective January 23, 2006, the MCL for arsenic was reduced to 10  $\mu\text{g/L}$ . The well was capped and the municipal water system was extended to the building in 1972.

### **SITE INVESTIGATION AND REMEDIATION**

The burial site was initially capped with clay in 1982 (USEPA, 1994). In 1985, after the site was listed on the MPCA Superfund List, soil exceeding 500 mg/kg (milligrams/kilograms) arsenic was excavated by a MPCA contractor and disposed off site. The excavated area was then filled with clean soil and covered with a clay cap and an impermeable membrane (USEPA, 1994). The former burial site is now paved.

During the 1992-1993 Remedial Investigation and Feasibility Study, the plume was found to be 600 feet long, 400 feet wide, and approximately 85 feet deep, extending eastward and downward from the former pit area (USEPA, 1994). In 1997, the U.S. Environmental Protection Agency (USEPA), with support from the MPCA, installed four remedial wells (Minnesota Unique Well Numbers 603609-603612) along the length of the contaminant plume. Contaminated groundwater has been extracted from the four wells, treated with an activated alumina adsorption system, and discharged to an on-site infiltration gallery. The extraction system remains in operation, managed by the MPCA.

As part of the site remediation, the water-supply well that served the Hammer's Construction Company was permanently sealed in 1993 (Well and Boring Sealing Number H39926). A second well (H39930) at Hammer's Construction and a nearby private well (H42740) were sealed in 1994.

The contaminant plume has been slow to migrate, has largely been contained by the extraction system, and has been diminishing in size and concentration because of the extraction system. Using 2004 data, the current plume is 480 feet long, 150 feet wide and 60 feet deep. In 1998, arsenic levels exceeded 1000 µg/L in EW-4 (nearest the source area) and 500 µg/L in the treatment system influent. Current levels in the four extraction wells are below 50 µg/L and the effluent of the treatment system to the infiltration gallery is at concentrations of <1 µg/L arsenic. Background levels of arsenic in groundwater in the surficial sand aquifer appear to be <1 µg/L. Nonetheless, there remain concerns that additional groundwater withdrawals could influence the plume distribution and disrupt the effectiveness of the extraction well system. In addition, the arsenic levels remaining in the plume still exceed the recently revised MCL for arsenic of 10 µg/L.

### **HYDROGEOLOGY**

The geology of the Perham area consists of a surficial deposit of ice contact and outwash sands and gravels, approximately 100 feet in thickness. The material is relatively coarse grained and is highly transmissive (MPCA, 1998). Static water levels are on the order of 21-25 feet below land surface (Johnson, 1998; Scheer, 2006). Underlying the surficial sand and gravel is glacial drift, which, in turn, overlies metasedimentary bedrock. The drift materials appear to contain some sand layers, which may provide sufficient water for water-supply wells.

Groundwater flow in the surficial sand and gravel is from west to east, discharging ultimately into the Otter Tail River, approximately 1.8 miles east of the site. Local lakes and streams may provide some local influence.

### **PUBLIC HEALTH CONCERNS**

The health effects of arsenic depend on its chemical form, the concentration in the water, how much water is consumed, and for how long. Inorganic arsenic poses a more serious health risk than organic arsenic found in plants and animals. A one-time "dose" of 60,000 micrograms of inorganic arsenic can be fatal.

Low concentrations of arsenic may cause adverse health effects when consumed over a long period of time. Arsenic may cause formation of corns (hyperkeratosis) in the palms of hands, the soles of feet, and elsewhere on the body. Arsenic concentrations exceeding 100 µg/L have been linked to chronic health problems such as diabetes, and deterioration of the circulatory and nervous systems, skin problems, and cancer of body organs when water is consumed over many decades.

The MCL, the drinking water standard applied to public-water supplies as established by the USEPA, was 50 µg/L for many decades. Effective January 23, 2006, the MCL was reduced to 10 µg/L. The MDH has not finalized a Health Risk Limit (HRL) for arsenic, but references the USEPA standard when assessing impacts on private wells.

### **BOUNDARIES OF THE SPECIAL WELL AND BORING CONSTRUCTION AREA**

The location of the SWBCA is shown in Figure 1. The area includes the south half of Section 14 and that portion of Section 23 north of State Highway 10 in Township 136 North, Range 39 West, Otter Tail County.

## **REQUIREMENTS IN THE SPECIAL WELL AND BORING CONSTRUCTION AREA**

1. All wells regulated by the MDH are subject to the requirements of this SWBCA. Wells include water-supply wells (domestic, public, irrigation, remedial heating/cooling commercial/industrial,), monitoring wells, and dewatering wells. Borings include elevators, environmental bore holes, and vertical heat exchangers. Notifications and plans for water-supply wells and dewatering wells, and permit applications for elevators, monitoring wells, and vertical heat exchangers must be submitted to the MDH, which will then consult with MPCA.
2. Construction of a new well or boring or modification of an existing well or boring (i.e., deepening the well, adding/removing casing below the frost line) may not take place until plans have been submitted to the MDH, in writing, and have been reviewed and approved (in writing) by the MDH. In addition to the information normally required for a notification or permit application, the plan must include the following information: street address; well depth; casing type, diameter, and depth; construction method, including grout materials and grout method, pumping rate; and well use.
3. Special well construction and/or monitoring requirements may be imposed on well or boring completion, location, and use in order to protect public health and groundwater quality and prevent further migration of contaminated groundwater. These requirements will be based on available knowledge of groundwater contamination and movement near the well site and the proposed use and pumping rate of the well.
4. Water-supply wells will not be approved in the surficial-outwash sand/gravel aquifer (approximately upper 100 feet) in the south half of Section 14 and that portion of Section 23 north of State Highway 10 for any potable uses. For purposes of the SWBCA, potable uses include consumptive uses or other uses involving human contact, including drinking, cooking, bathing, manufacturing or processing food, drink, or pharmaceuticals, or to supply water to plumbing fixtures accessible to humans or animals.
5. Only wells cased and grouted into an aquifer below or within the drift underlying the surficial sand/gravel aquifer may be considered for potable uses within the SWBCA. The well must be grouted from within 10 feet of the bottom of the casing to the surface to prevent any introduction/migration of contaminated groundwater from the surficial aquifer. The casing and annular grout seal must fully penetrate a confining layer, as defined in Minnesota Rules, part 4725.0100, subpart 24a.
6. MDH may consider allowing a well completed within the surficial sand/gravel aquifer for portable uses within Section 23 of the SWBCA under the following conditions:
  - The community public water supply is not currently available to the site.
  - The well use is to be only for domestic purposes.
  - The well owner agrees, in writing, to a schedule for arsenic testing of the well. Testing must be performed by a laboratory certified by the MDH to perform arsenic testing. Testing results must be reported to the MDH.
  - The well owner agrees, in writing, to connect to the community public water supply once it becomes available to the site.
  - The well owner agrees, in writing, to seal the well once the property is connected to the community public water supply.

7. For all other water-supply wells (including irrigation wells and remedial wells dewatering wells, monitoring wells, and borings, the MDH will consider approval of construction or reconstruction of a well completed in the surficial sand/gravel aquifer only if the water use and discharge do not pose a threat to public health or the environment, and if it is demonstrated that the well use will not alter the extent and distribution of the contaminant plume or the performance of the remediation system.
8. For all wells completed within the SWBCA, the owner must agree to pay the MDH for an arsenic analysis of a water sample collected from the well. The well contractor, monitoring well contractor, or limited well/boring contractor must contact the MDH Fergus Falls district office staff to arrange sample collection and sample analysis by the MDH laboratory. MDH will report the analytical results to the well owner and the MPCA.
9. The well owner must allow the MDH to resample the well for arsenic analysis approximately one year following the previous original analysis. MDH will report the analytical results to the well owner and the MPCA.
10. No well or boring may be permanently sealed until the MDH has received, reviewed, and approved (in writing) the plans for the proposed sealing. In addition to the required notification, the plan must include the following information: street address; original well/boring depth; current well/boring depth (if different); casing type(s), diameter(s), depth(s); methods of identifying and sealing any open annular space(s); methods of identifying and removing any obstructions; grout materials; and sealing methods.
11. Contractors must contact the MDH Fergus Falls district office by phone at least 24 hours prior to start of drilling a new well or boring, modification of an existing well or boring, or sealing of a well or boring. The verbal notification must be made during normal business hours (Monday through Friday, 8 a.m. to 4:30 p.m.) and must specify the date work is to begin.
12. All provisions of Minnesota Rules, Chapter 4725, are in effect.

## **PERSONS TO CONTACT**

For additional information regarding this SWCA, please contact:

Michael Convery  
Minnesota Department of Health  
Well Management Section  
P.O. Box 64975  
St. Paul, Minnesota 55164-0975  
651-201-4586  
*michael.convery@state.mn.us*

Plans for construction, repair, and sealing of wells (water-supply wells, monitoring wells, and dewatering wells) within the SWCA must be submitted to: Jeff Grugel

Minnesota Department of Health  
Fergus Falls District Office  
1505 Pebble Lake Road, Suite 300  
Fergus Falls, Minnesota 56537-3858  
218-332-5148  
*jeff.grugel@state.mn.us*

Notifications for construction or sealing of wells and permits for construction of monitoring wells must be mailed or faxed to:

Minnesota Department of Health  
Well Management Section  
P.O. Box 64502  
St. Paul, Minnesota 55164-0502  
651/201-4600  
Fax: 651/201-4599

For information regarding health effects, please contact: Mr. Carl Herbrandson  
Minnesota Department of Health  
Site Assessment & Consultation Unit  
P.O. Box 64975  
St. Paul, Minnesota 55164-0975  
651/201-4906  
*carl.herbrandson@state.mn.us*

For information regarding the investigation, monitoring, and remediation of the Perham Arsenic Site, please contact: Ms. Susan Johnson/Ms. Barbara Gnabasik

Minnesota Pollution Control Agency  
Remediation Division  
525 Lake Avenue South, Suite 400  
Duluth, Minnesota 55802  
218-302-6601/218-302-6602  
*susan.johnson@state.mn.us/barb.gnabasik@state.mn.us*

## **REFERENCES**

Johnson, M., 1998, Request for Special Well Construction Area - Perham Arsenic Site, 13 pages.

Scheer, D. 2006, Summary Spreadsheets of Environmental Data – Perham Arsenic Site, 57 pages.

United States Department of Health and Human Services, 1999, Health Consultation – Perham Arsenic Site, 10 pages.

United States Environmental Protection Agency, 1994, Record of Decision – Perham Arsenic Burial Site, 41 pages.

**PERHAM ARSENIC SITE  
SPECIAL WELL AND BORING CONSTRUCTION AREA MAP**

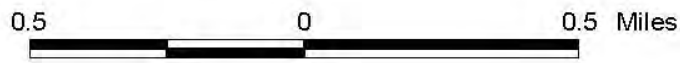
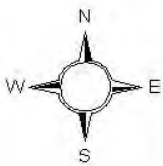
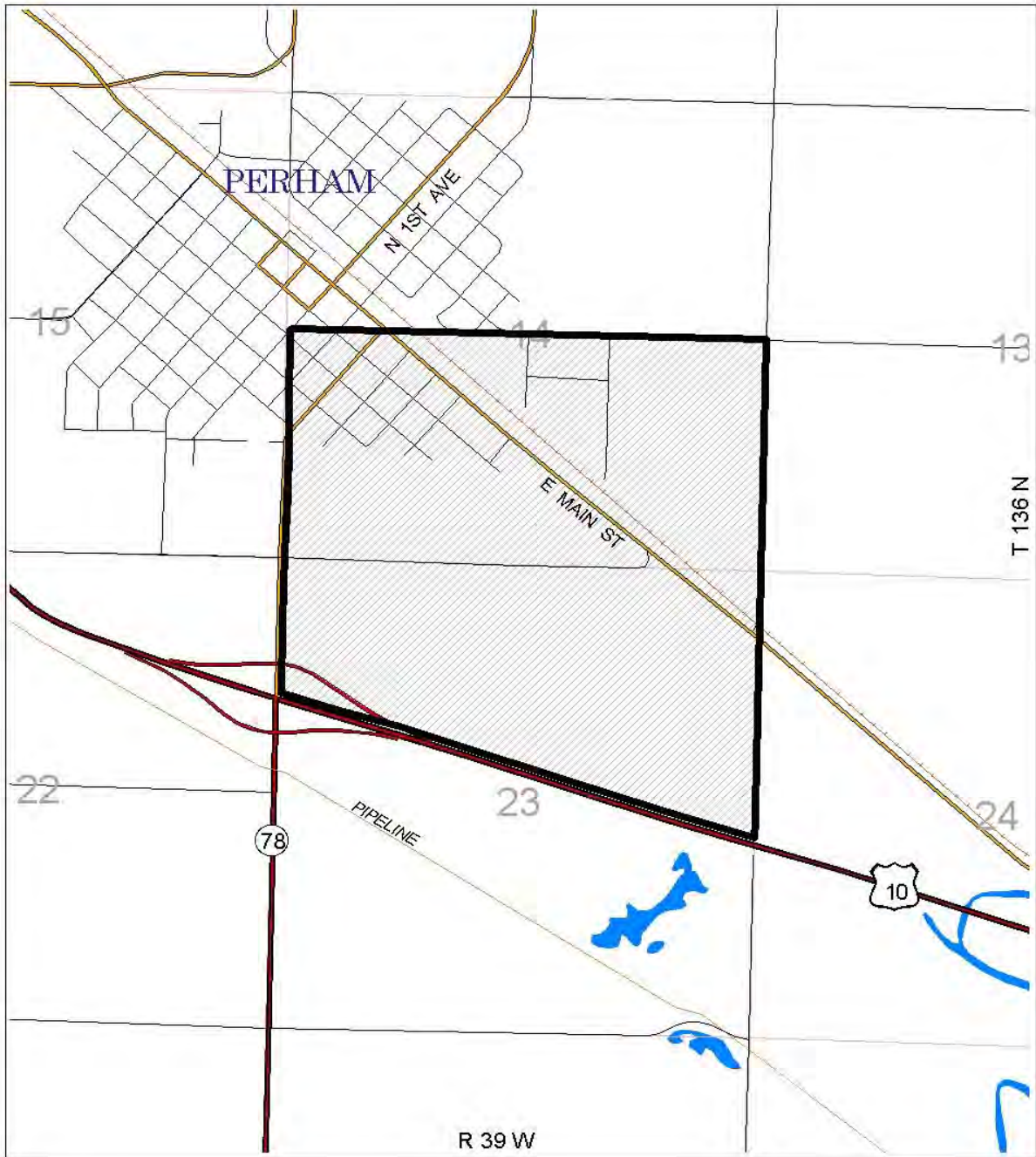

15 Nov 2006 Minnesota Department of Health - Well Management Section



## **ST. PAUL PARK AND NEWPORT SPECIAL WELL AND BORING CONSTRUCTION AREA**

### **SUMMARY**

Date SWBCA Issued: November 10, 1997  
SWBCA Size: Approximately 1-1/2 Square Miles  
Location: Newport and St. Paul Park, Washington County  
Major Contaminants: Multiple VOC's with TCE Predominating, Petroleum Products, and Pentachlorophenol  
Aquifers Affected: Glacial Sediments, Prairie du Chien Formation, Jordan Formation

The MDH designated a Special Well Construction Area (now a SWBCA) on November 1, 1997, for portions of St. Paul Park and Newport.

Groundwater in portions of the SWBCA area has been contaminated as a result of spills, leaks, or disposal of chlorinated solvents and petroleum products at several industrial sites, including the Ashland Refinery, the former Aero Precision Engineering Company, and the former Park Penta Corporation. Several groundwater contaminant plumes originating from these (and possibly other) sites have spread to the west and southwest, toward the Mississippi River. Groundwater contaminants include petroleum products, several volatile organic chemicals (VOCs), and pentachlorophenol.

### **SITE HYDROGEOLOGY**

The glacial deposits are thin in the area, ranging from a few feet to approximately 50 feet in thickness. The Prairie du Chien formation is the first bedrock encountered. It is approximately 110 feet thick in the SWBCA. The water table occurs at a depth of 25 to 30 feet below ground surface. The Jordan underlies the Prairie du Chien, and is approximately 70 to 100 feet thick. The St. Lawrence formation, which is a confining layer approximately 35 to 60 feet thick, underlies the Jordan Aquifer. The Franconia-Ironton-Galesville Aquifer underlies the St. Lawrence formation and is over 300 feet thick.

### **CONTAMINATION**

Contamination has been found in the Prairie du Chien bedrock formations. The top of the bedrock is found at or within several feet of the ground surface in most of the area. Lower contaminant concentrations have also been detected in the underlying Jordan aquifer. Limited groundwater monitoring in the Jordan Aquifer indicates that pentachlorophenol (PCP) and VOCs are present at concentrations below the current health risk limits (HRLs). The St. Lawrence and Franconia have not been monitored.

Ashland has implemented extensive remedial measures at the refinery and Park Penta sites. The MPCA, using state Superfund money, has implemented remedial measures at the former Aero Precision facility. These remedial measures are expected to be effective, but it will be many years before groundwater is fully protected. The MDH and the MPCA are concerned about the public health effects that could result from the use of water-supply wells in the contaminated aquifers prior to the cleanup completion. The MDH and MPCA are also concerned that the construction of new wells or modification of existing wells within the SWBCA may interfere with cleanup efforts, or may cause further spread of the contamination. It is also important to assure that unused wells are properly sealed.

## **BOUNDARIES OF THE SPECIAL WELL AND BORING CONSTRUCTION AREA**

The location of the SWBCA is shown on the following map. Beginning at the intersection of Second Street and Hastings Avenue in Newport, the boundary of the Special Well Construction Area extends southeast on Hastings Avenue to Pleasant Avenue in St. Paul Park, then west on Broadway Avenue to the railroad tracks, then southeast on the railroad tracks to a point due east of Eleventh Avenue, then west to the Mississippi River, then north along the river to a point due west of Second Street in Newport, then east to the intersection of Second Street and Hastings Avenue. This area is entirely within Washington County, and includes parts of Sections 1, 2, 11, and 12 in T27N, R22W.

## **REQUIREMENTS IN THE SPECIAL WELL AND BORING CONSTRUCTION AREA**

1. All wells regulated by the MDH are subject to the requirements of this SWBCA. This includes potable water-supply wells, irrigation wells, commercial and industrial water-supply wells, wells for heating and cooling, remedial wells, monitoring wells, and dewatering wells.
2. Construction of a new well, or modification of the depth of an existing well, may not take place until after the MDH has reviewed and approved plans for the proposed construction. In addition to the required permit application or notification, the plan must include the following information: street address; well depth; casing type, diameter, and depth; method of construction, including grout materials and grout method; pumping rate; and well use.
3. Special well construction and/or monitoring requirements may be imposed on a case-by-case basis in order to protect groundwater quality and prevent migration of contaminants. These requirements will be based on available knowledge of groundwater contamination and movement near the well site, and the proposed use and pumping rate of the well. Special requirements may include completion of the well in or below the Franconia formation, with casing and grout emplaced through all overlying formations.
4. Well construction or reconstruction will not be approved if the MDH, in consultation with the MPCA, concludes that the proposed construction or reconstruction may interfere with cleanup efforts, cause further spread of contamination, or result in human exposure to contaminants at concentrations exceeding MDH HRLs.
5. If the proposed construction or reconstruction of a potable water-supply well is approved, the MDH may require that one or more water samples be collected and analyzed for VOCs and/or pentachlorophenol before the well is grouted and put into service. If contamination is present in excess of HRLs, the well must be permanently sealed or reconstructed.
6. The permanent sealing of a well may not take place until after the MDH has reviewed and approved plans for the proposed sealing. In addition to the required well sealing notification, the plan must include the following information: street address; original well depth; current well depth; casing type(s), diameter(s) and depth(s); methods for identifying and sealing any open annular space; methods for identifying and removing any obstructions; and grout material and methods.

## **PERSONS TO CONTACT**

### Minnesota Department of Health

For additional information regarding this SWBCA, contact:

Ed Schneider  
Well Management Section  
P.O. Box 64975  
St. Paul, Minnesota 55164-0975  
651-201-4595  
*ed.schneider@state.mn.us*

For information regarding plan review, well construction and well sealing, or water sampling contact:

Patrick Sarafolean  
Well Management Section  
P.O. Box 64975  
St. Paul, Minnesota 55164-0975  
651-201-3962  
*patrick.sarafolean@state.mn.us*

### Minnesota Pollution Control Agency

For information regarding contamination investigation, monitoring, and remediation contact:

Elizabeth Gawrys  
Superfund & Emergency Response Section  
520 Lafayette Road  
St. Paul, Minnesota 55155  
651-757-2380  
*elizabeth.gawrys@state.mn.us*

Steven Schoff  
Superfund & Emergency Response Section  
520 Lafayette Road  
St. Paul, Minnesota 55155  
651-757-2701  
*steven.schoff@state.mn.us*

# ST. PAUL PARK AND NEWPORT SPECIAL WELL AND BORING CONSTRUCTION AREA MAP

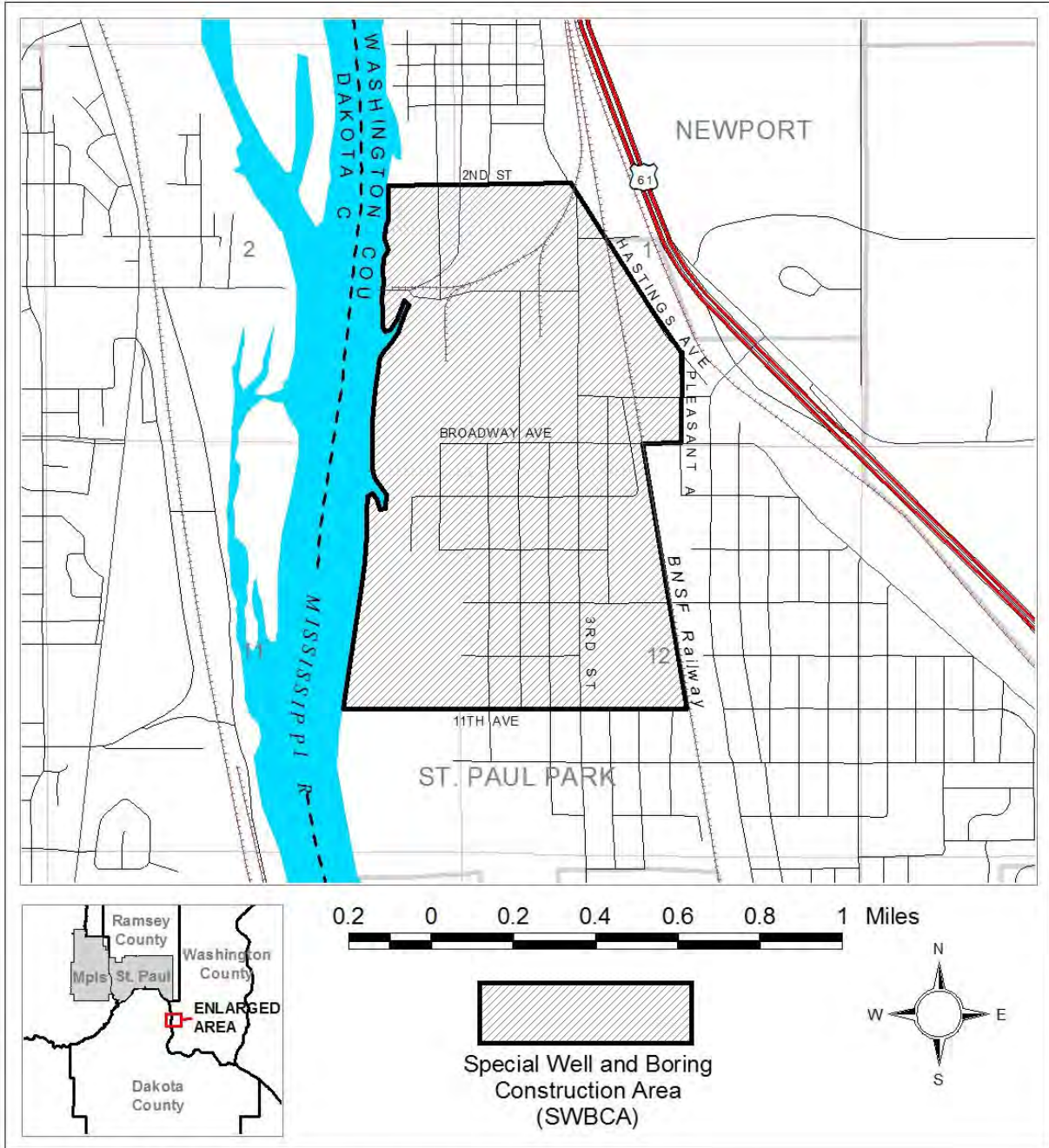

Minnesota Department of Health - Well Management Section  
 May 25, 2010  
 stpaulpark swbca.apr

## **SPRING GROVE AND SPRING GROVE TOWNSHIP SPECIAL WELL AND BORING CONSTRUCTION AREA**

### **SUMMARY**

Date SWBCA Issued: January 1, 2007  
SWBCA Size: Approximately 1 Square Mile  
Location: The City of Spring Grove, and an area Bordering the City to the North, East, and South, Houston County  
Major Contaminant: Trichloroethylene  
Aquifers Affected: Galena, Platteville, St. Peter, Prairie du Chien, and Jordan

### **SITE HISTORY**

The city of Spring Grove is the third largest city in Houston County and is located along State Highway 44, approximately 15 miles southwest of Caledonia. In 1984, routine monitoring of the Spring Grove municipal wells identified contamination by 1,1,2-trichloroethylene (TCE) in Municipal Well Number 3 located in easternmost Spring Grove. Subsequent sampling of private wells and monitoring wells identified TCE contamination in all three municipal wells and a number of private wells, particularly east and southeast of the city.

The source of contamination was identified as the site of the Northern Engraving Corporation (NEC), which had previously been used by Control Data Corporation (now Ceridian) as a printed circuit board plant.

A number of remedial actions have been taken, including:

- Installation of an air stripper on Municipal Well Number 3 in 1989.
- Pumpage of Recovery Well Number 5A, starting in 1991, with conversion to a dual-phase, vapor extraction system in 2000. Discharge is treated by carbon treatment before discharge to the sanitary sewer.
- Pumpage of Municipal Well Number 1, starting in 1989, with discharge to storm sewer and Seven Mile Creek (Aeration reduces TCE contamination).
- Conversion of a private well number 2 to a monitoring well/recovery well, with pumping and discharge to the sanitary sewer system, starting in 1993.
- Excavation of 30-35 cubic yards of TCE-contaminated soil at the NEC facility in 2000. Remaining source area soils capped with asphalt.
- Installation of carbon treatment systems on six private wells used for potable water supply (currently four wells are still in use).

In July 2000, the Minnesota Pollution Control Agency (MPCA) requested that the MDH consider establishing a Special Well and Boring Construction Area (SWBCA) for Spring Grove. In 2002, the United States Environmental Protection Agency (USEPA) reevaluated the health risks associated with TCE, the primary contaminant of concern in Spring Grove. Subsequently, the MDH issued an interim recommended exposure limit of 5 micrograms/liter (5 µg/l). Ongoing monitoring conducted by Gannett Fleming, consultant to Northern Engraving Corporation (NEC) and Ceridian Corporation (CDC), and reported to the MPCA indicates that the extent of groundwater contamination has stabilized and does not appear to be migrating. However, TCE at concentrations exceeding 5 µg/L persists in groundwater in and near Spring Grove.

## **SITE HYDROGEOLOGY**

The city of Spring Grove is located on a bedrock plateau, with deeply incised valleys radiating out to the north and the south, with a drop in elevation on the order of 200-250 feet. This area is within the “driftless” area and the unconsolidated materials consist of approximately 10-15 feet of loess on top of bedrock.

The first bedrock within the city of Spring Grove is the Galena limestone. The first bedrock in the valleys near the city is St. Peter sandstone or Shakopee dolomite (part of the Prairie du Chien group). Groundwater within the Galena limestone, Platteville limestone, and St. Peter sandstone is perched, the units are not fully saturated, and they generally have not been used for water supply.

Prior to implementation of state-wide well regulation, the construction of many wells simply involved placement of casing to rock, with open-hole completion through all of the geologic units from the Galena limestone through the Prairie du Chien group. This construction method bypassed two major regional confining layers – the Decorah shale and the Glenwood shale, which normally would provide excellent protection of the underlying hydrogeologic units from surface contamination migrating downwards. Even wells that were cased through these confining layers may not have been grouted to seal the annular spaces and are, in effect, multiaquifer wells. It appears that multiaquifer wells on or near the NEC site may have played some role in contamination migrating at least into the Prairie du Chien group. These well construction problems also create uncertainty as to exactly where the TCE contamination occurs since any water sample from a particular well may reflect contributions from more than one aquifer.

## **PUBLIC HEALTH CONCERNS**

The primary contaminant of concern within the SWBCA is TCE. TCE was most commonly used as a degreasing agent for cleaning metal parts and surfaces. Exposure to high levels of TCE in drinking water can damage the liver, kidneys, immune system, and nervous system. Exposure to low levels of TCE over a long period of time may be linked to an increased risk of several types of cancer. TCE may also harm a developing fetus if consumed in high concentrations by an expectant mother. The MDH Health Risk Limit (HRL) for TCE in drinking water is 5µg/L.

## **BOUNDARIES OF THE SPECIAL WELL AND BORING CONSTRUCTION AREA**

The location of the SWBCA is shown on the attached map (Figure 1). This area includes Sections 11, 12, 13, and 14 of Township 101 North, Range 7 West. The entire limits of the city of Spring Grove are within the SWBCA.

## **REQUIREMENTS IN THE SPECIAL WELL AND BORING CONSTRUCTION AREA**

1. All wells and borings regulated by the MDH are subject to the requirements of this SWBCA. Wells include water-supply wells (domestic, public, irrigation, commercial/industrial, cooling/heating, remedial), monitoring wells, and dewatering wells. Borings include environmental bore holes, elevators, and vertical heat exchangers. Permit applications and notifications must be submitted to MDH.
2. Construction of a new well or boring, or modification of the depth of an existing well or boring, may not occur until plans have been reviewed and approved, in writing, by MDH. In addition to the normally required notification or permit application, the plan must include the following information: street address; well or boring depth; casing type, diameter, and depth; construction method(s), including grout materials and grout methods; pumping rate; and use.
3. Special well construction and/or monitoring requirements may be imposed on well or boring completion, location and use in order to protect public health and groundwater quality and to prevent contaminant migration. These requirements will be based on available knowledge of groundwater contamination and movement near the well site and the proposed use and pumping rate of the well.

4. Under Minnesota Rules, part 4725.4250, subpart 4, item A, a water-supply well for potable uses must not be completed in a limestone or dolomite unless these geologic units are overlain by 50 feet of unconsolidated material, sandstone or shale that extends around the well for a minimum one-mile radius. This rule requirement prohibits completing potable water-supply wells in the Galena limestone, Platteville limestone, and Prairie du Chien group within the designated SWBCA.
5. No potable water-supply wells, except as provided in item 6, may be completed within the Jordan sandstone within the limits of the city of Spring Grove. For purposes of this SWBCA, potable uses include any consumptive or other uses involving human contact, including drinking, cooking, bathing, manufacturing or processing of food, drink, or pharmaceuticals, or to supply water to fixtures accessible to humans.
6. Approval of plans and specifications for construction or modification of a community public water-supply well and approval of the well site is required by Minnesota Rules, part 4725.5850. The MDH may consider completion of a community public water-supply well in the Jordan sandstone if the system operator/owner can demonstrate that the water delivered to the distribution system meets U.S. EPA Maximum Contaminant Limits (MCLs), either through treatment, blending with other sources, monitoring, or other mechanisms. The MDH regularly monitors public water supplies for contaminants. The MCL for TCE is 5 µg/L.
7. A well used for nonpotable purposes or a boring may be completed into the Galena limestone, Platteville limestone, St. Peter sandstone, Prairie du Chien group, Jordan sandstone, or deeper bedrock formations, in accordance with Minnesota Rules, Chapter 4725, anywhere within the SWBCA, provided that the MDH and MPCA determine that use of the well or boring will not interfere with remediation efforts, cause further spread of contamination, or result in human exposure to contaminants at concentrations exceeding MCLs, HRLs, or other relevant public health standards.
8. Water-supply wells for potable purposes may be completed in the Jordan sandstone in those areas within the SWBCA but outside the city of Spring Grove with the permission of the MDH. Before permission to construct the well is granted, the well owner must agree to pay the MDH for a volatile organic chemical (VOC) analysis on a water sample collected from the well prior to grouting the annular space surrounding the casing. The well contractor must contact MDH – Rochester district staff to arrange a pre-grout sample and send the sample to the MDH laboratory for analysis. The well may not be grouted until sample results are available indicating contaminant levels below HRLs.
9. If the analytical results exceed a HRL, the contractor and the well owner, at the well owner's expense, have the option of inserting a packer to seal off the Jordan sandstone and having a water sample collected from below the packer for VOC analysis to obtain a representative sample of that aquifer. The contractor must contact MDH – Rochester district staff to arrange for MDH staff to take a sample and to send the sample to the MDH laboratory for analysis. The well may not be grouted until sample results are available indicating contaminant levels below HRLs.
10. If the results of an analytical test for VOC's exceed the HRLs on the pre-grout sample or, if performed, on the sample with packer, the contractor must remove the casing, continue drilling the well through the St. Lawrence formation and into the Franconia formation or deeper, install the casing into the Franconia formation or deeper, and grout the annular space around the casing from the bottom of the casing to the ground surface.
11. For a water-supply well completed within the Jordan sandstone, the casing must extend a minimum of 10 feet into the formation.

12. If the results of VOC testing detect the presence of any VOC below HRLs, the well owner must test the well again for VOC's one year following completion of the well. Samples must be analyzed by a laboratory certified by the MDH under Minnesota Rules, Chapter 4740. The well owner must report the results to the MDH – Rochester district office within 30 days of receipt of the test results.
13. Well and boring construction or reconstruction will not be approved if the MDH, in consultation with the MPCA, concludes that the proposed construction or reconstruction and the well use will interfere with remediation efforts, cause further spread of contamination, or result in human exposure to contaminants at concentrations exceeding MCLs, HRLs, or other relevant standards.
14. Completion of wells and borings in bedrock formations below the St. Lawrence formation will be allowed without any VOC testing requirement.
15. The permanent sealing of a well or boring in bedrock may not occur until after MDH has reviewed and approved the plans for the proposed sealing. The MDH must provide written approval of the plans in order to proceed with well sealing. In addition to the required notification, the plan must include the following information: street address; original well/boring depth; current well/boring depth (if different); casing type(s), diameter(s), depth(s); methods of identifying and sealing any open annular space; methods for identifying and removing any obstructions; grout materials and grouting methods.
16. All provisions of Minnesota Rules, Chapter 4725, are in effect.

#### **PERSONS TO CONTACT**

For additional information regarding this SWCA, please contact Michael Convery of the MDH at 651-201-4586.

Plans for construction, modification, or sealing of wells and borings within the SWCA must be submitted to: Chris De Mattos

Minnesota Department of Health, Rochester District Office  
18 Wood Lake Drive Southeast  
Rochester, Minnesota 55904  
507-206-2722  
*chris.demattos@state.mn.us*

Notifications for construction, modification, or sealing of wells must still be mailed or faxed to the MDH Well Management Section central office at: Minnesota Department of Health

Well Management Section  
P.O. Box 64502  
St. Paul, Minnesota 55164-0502  
651-201-4600  
Fax: 651-201-4599



For information regarding health effects, please contact:

Rita Messing  
Minnesota Department of Health  
Site Assessment and Consultation Unit  
P.O. Box 64975  
St. Paul, Minnesota 55164-0975  
651-201-4916  
*rita.messing@state.mn.us*

For information regarding the investigation, monitoring, and remediation of the Spring Grove groundwater contamination site, please contact:

Dan Card  
Minnesota Pollution Control Agency  
Majors and Remediation Division  
Superfund Section  
520 Lafayette Road North  
St. Paul, Minnesota 55155-4194  
651-757-2261  
*dan.card@state.mn.us*

## **REFERENCES**

Gannett Fleming, Inc., 2006, 2005, 2004 Annual Monitoring Report for Spring Grove, Minnesota, Site, 34p.

**SPRING GROVE AND SPRING GROVE TOWNSHIP  
SPECIAL WELL AND BORING CONSTRUCTION AREA MAP**

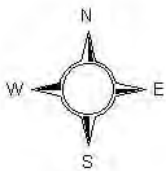
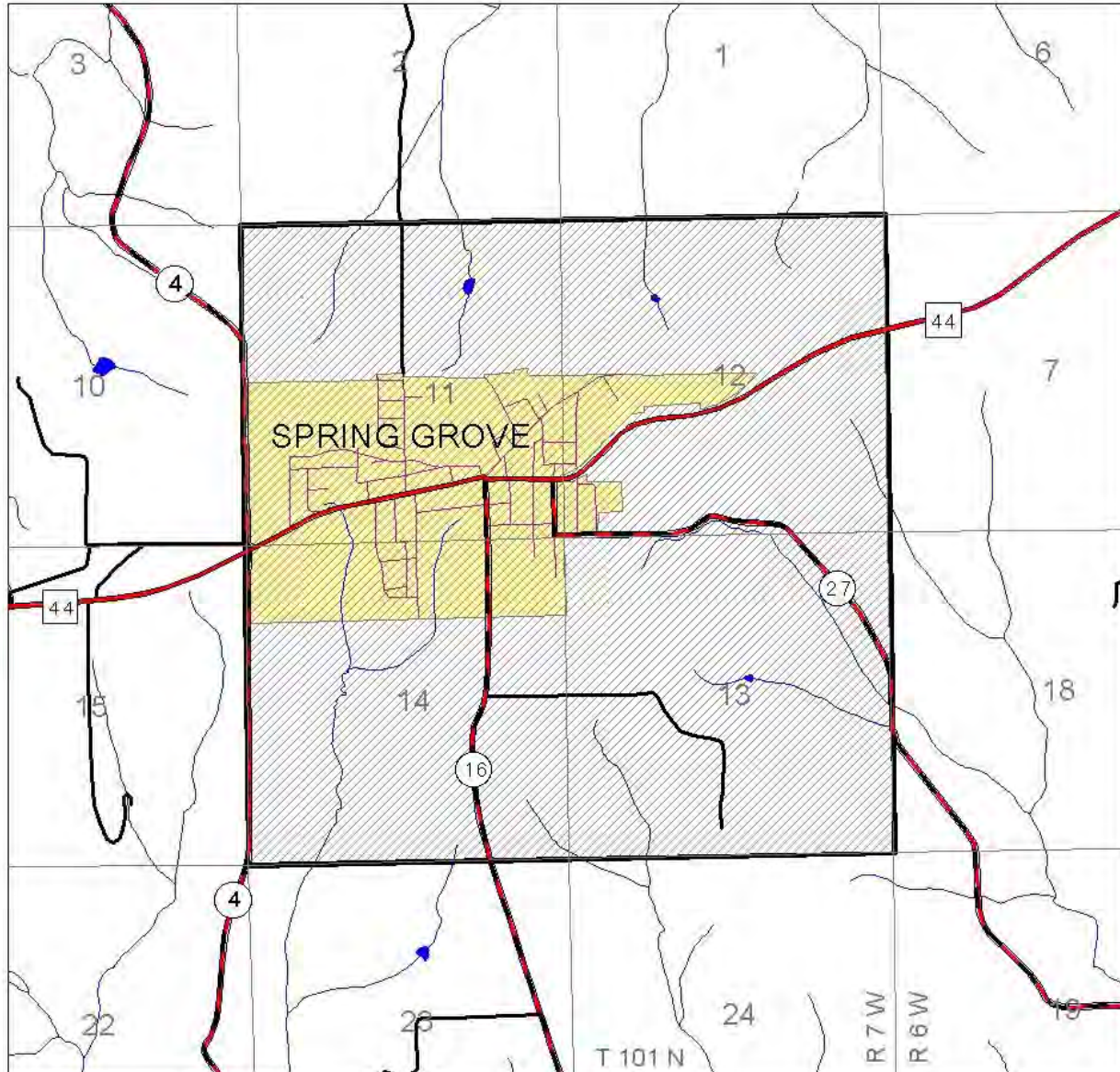

01 Feb 06

Minnesota Department of Health - Well Management Section

## **TWIN CITIES ARMY AMMUNITION PLANT (TCAAP) SPECIAL WELL AND BORING CONSTRUCTION AREA**

### **SUMMARY**

Date SWBCA Issued: July 1, 1996  
SWBCA Size: Approximately 36 square miles  
Location: New Brighton, St. Anthony, and portions of Fridley, Mounds View, Arden Hills, Shoreview, Columbia Heights, Minneapolis, Falcon Heights, Lauderdale, Roseville, and St. Paul, Anoka, Hennepin, and Ramsey Counties  
Major Contaminants: Numerous contaminants, but predominately TCE  
Aquifers Affected: Glacial Sediments (Fridley Formation and Hillside Sand), Prairie du Chien, Jordan

The Twin Cities Army Ammunition Plant (TCAAP) is a federal facility located in Arden Hills, Ramsey County. The plant began manufacturing small arms ammunition for World War II in 1941. Investigations by the MPCA have identified 24 known waste sites on the 4 square mile facility. The SWBCA includes a large area south of the facility, but does not include those portions of the TCAAP facility under Federal military control. The TCAAP site is the largest Special Well and Boring Construction Area (SWBCA) and the Number 1 National Priorities List (Superfund) site in Minnesota.

### **SITE HYDROGEOLOGY**

The geology of the area consists of a discontinuous layer of alluvium and lacustrine deposits (Fridley formation) over glacial till (Twin Cities formation), over the Hillside sand. The combined thickness of the unconsolidated formations range from 50 to 300 feet. The first bedrock encountered is the Prairie du Chien formation near the TCAAP facility, and the St. Peter or Platteville formations to the south and west.

### **CONTAMINATION**

On the site itself, contaminants include volatile organic chemicals (VOC), metals, polychlorinated biphenyls (PCB), semivolatiles, explosives, propellants, phenol, pesticides, oil, dioxins, cyanide, and others. The predominant chemical affecting offsite groundwater is trichloroethylene, and to a lesser extent, trichloroethane.

The SWBCA now incorporates two areas of groundwater contamination related to volatile organic chemicals (VOCs) contamination at and around the TCAAP plant. The largest area of contamination extends several miles to the south and west of TCAAP, to depths of several hundred feet. Portions of the buried sand aquifer (Hillside Sand formation) and the Prairie du Chien dolomite and Jordan sandstone bedrock formations have been contaminated with VOCs, principally trichloroethene (TCE). A second, much smaller area of VOC contamination exists in the surficial sand deposits (Fridley formation) north and west of TCAAP to depths of approximately 45 feet. The Platteville, Glenwood, and St. Peter formations have not been shown to be contaminated.

The cities of New Brighton and Arden Hills have sealed several municipal wells and installed new wells into the Mt. Simon formation. Granular activated carbon treatment systems were installed for the cities of New Brighton and St. Anthony.

Over 94,000 cubic yards of contaminated shallow soil has been remediated. More than 200,000 pounds of VOCs have been removed from deep soils. Approximately 1.2 billion gallons of groundwater are treated each year with over 35 billion gallons of groundwater being treated to date. Over 150,000 pounds of VOCs have been removed from the deep groundwater. The Army has spent in excess of 184 million dollars on investigation and remediation.

## **BOUNDARIES OF THE SPECIAL WELL AND BORING CONSTRUCTION AREA**

On July 1, 1996, the MDH designated a Special Well Construction Area (now a SWBCA) incorporating the cities of New Brighton, St. Anthony and portions of Arden Hills, Columbia Heights, Falcon Heights, Fridley, Lauderdale, Minneapolis, Moundsview, Roseville, and Shoreview, which are located in Anoka, Hennepin, and Ramsey Counties.

In June 1999, the MPCA requested that the MDH extend the SWBCA boundary for the larger contamination plume farther to the southwest to the Mississippi River in Minneapolis, and Marshall Avenue in St. Paul. The eastern boundary of the extension area is Cleveland Avenue, between Larpenteur Avenue on the north and Marshall Avenue on the south. The western boundary of the extension area is a continuation of Central Avenue to the Mississippi River. The boundaries of the original area north of Larpenteur Avenue and Hennepin Avenue remain unchanged. The revised boundaries of the SWBCA are shown on the map. The SWBCA includes Parts of Sections 4, 9, 16 and 33, and all of Sections 7, 8, 17-22, and 27-32, T30N, R23W, Ramsey County; parts of Sections 4, 9, 16 and 31, and all of Sections 5-8, 17-20, and 29-32, T29N, R23W, Ramsey and Hennepin Counties; parts of Sections 12, 13 and 24, all of Sections 25 and 36, T30N, R24W, Anoka County; and parts of Sections 14 and 23-25, and all of Sections 1, 12, and 13, T29N, R24W, Hennepin County. The SWBCA covers approximately 36 square miles.

## **REQUIREMENTS IN THE SPECIAL WELL AND BORING CONSTRUCTION AREA**

Wells within the SWBCA may not be constructed or modified until after the MDH, and city of Minneapolis for those wells located within Minneapolis, have reviewed and approved plans for the proposed activity. Wells completed in or below the Prairie du Chien dolomite may not be sealed until after the MDH (and the city of Minneapolis, where applicable) have reviewed and approved plans.

## **PERSONS TO CONTACT**

### Minnesota Department of Health

For information regarding plan review, well construction, well sealing, or water sampling contact:

Patrick Sarafolean.  
Well Management Section  
P.O. Box 64975  
St. Paul, Minnesota 55164-0975  
651-201-3962  
*patrick.sarafolean@state.mn.us*

### City of Minneapolis

For information regarding plan review, well construction, well sealing, or water sampling contact:

Alison Fong (water-supply and monitoring wells located in the City of Minneapolis)  
Environmental Management  
250 South Fourth Street, Room 414  
Minneapolis, Minnesota 55415  
612-673-3179  
*alison.fong@ci.minneapolis.mn.us*

Minnesota Pollution Control Agency

For information regarding the contaminant investigation or remediation contact:

Dagmar Romano  
Superfund, RCRA, and Voluntary Cleanup Section  
520 Lafayette Road  
St. Paul, Minnesota 55155  
651-757-2676  
*dagmar.romano@state.mn.us*

Elizabeth Gawrys  
Industrial Division  
520 Lafayette Road  
St. Paul, Minnesota 55155  
651-757-2380  
*elizabeth.gawrys@state.mn.us*

**TWIN CITIES ARMY AMMUNITION PLANT (TCAAP)  
SPECIAL WELL AND BORING CONSTRUCTION AREA MAP**

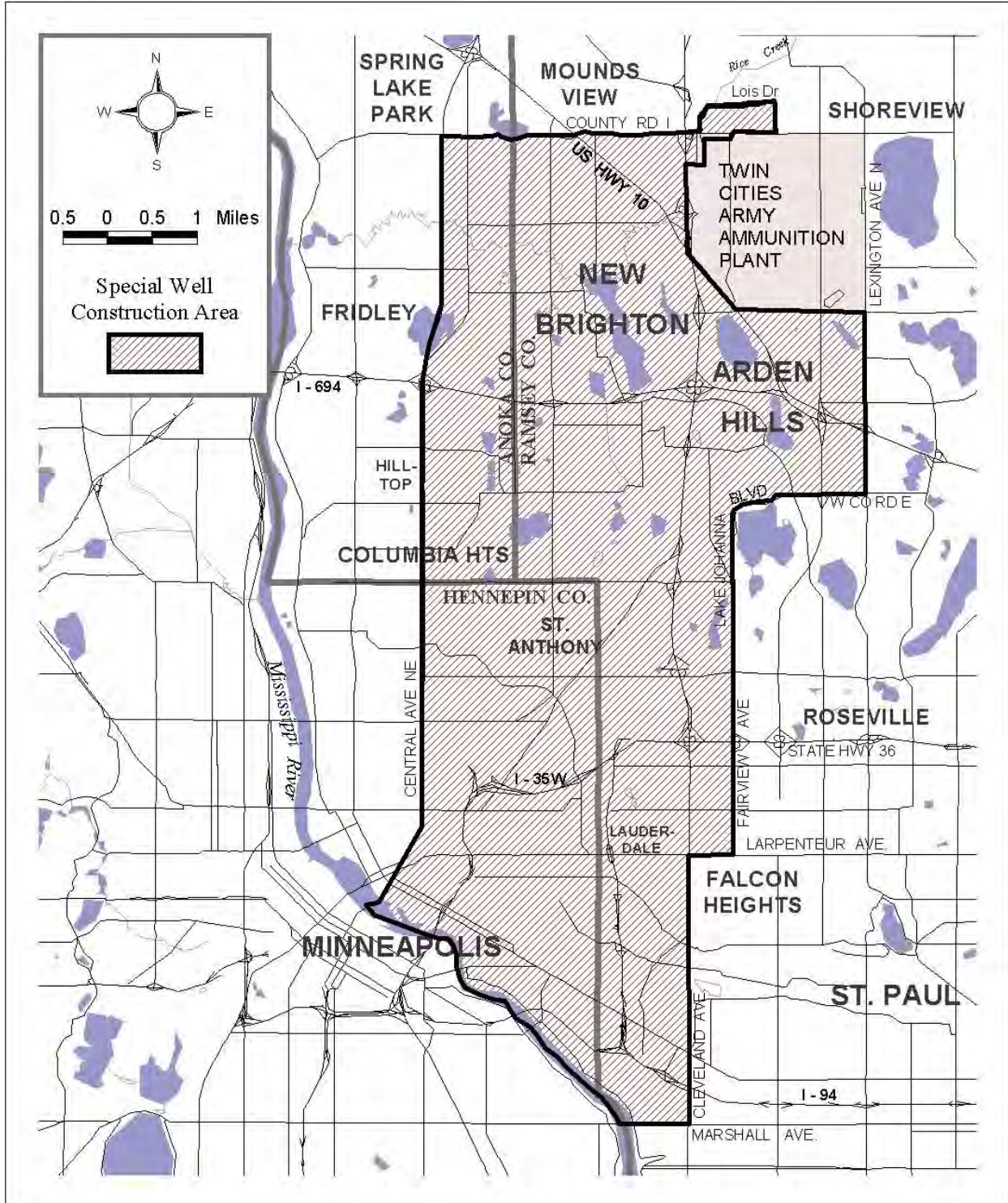

## WATER QUALITY

### ARSENIC

Many Minnesotans are surprised to learn that they may have arsenic in their well water. Despite its reputation as a poison, arsenic is like any toxic substance; its effects depend on how much and how long people are exposed to it. This publication tells about arsenic and its health effects, and what you can do if you have arsenic in your well water.

#### **How does arsenic get into drinking water?**

Arsenic is a part of the earth's crust and occurs naturally in soil and rock. Arsenic from soil and rock can dissolve into groundwater, the primary source of drinking water for much of Minnesota. When arsenic occurs in well water, the source is almost always a natural source.

Human activities can sometimes contribute to arsenic in groundwater, as well as in soil and air. While arsenic is not in common use today, it was once an ingredient in some pesticides, and residues remain from past use and improper disposal. Until January 2004, arsenic-based wood preservatives were used to treat some wooden foundations, decks, and children's play structures. Arsenic from these sources does not usually move very far in the environment.

#### **Is arsenic common in Minnesota's well water?**

Arsenic can occur in groundwater just about anywhere in Minnesota. Groundwater from the Twin Cities to the South Dakota border, and north along Minnesota's border with the Dakotas is more likely to contain elevated levels of arsenic. However, arsenic levels can vary from one well to the next, even within a very small area.

Most arsenic in Minnesota groundwater is thought to come from rock deposits that were eroded and re-deposited with clay by glaciers thousands of years ago. Arsenic is present in all soil and rock, but more arsenic dissolves into groundwater under certain conditions. In some areas, water from wells that are completed just below a layer of clay at least 10 feet thick can have higher levels of natural arsenic than water from wells completed deeper. Some groundwater in Minnesota has natural arsenic levels as high as 150 micrograms per liter. One "microgram per liter" is the same as 1 "part per billion." The federal drinking water standard for arsenic is 10.0 micrograms per liter (more on this later).

Studies of groundwater in Minnesota and some other states suggest that natural arsenic concentrations exceeding 10 micrograms per liter are more common than previously recognized. Based on existing monitoring data, it is now estimated that about 10 percent of all wells in Minnesota have natural arsenic levels of 10 micrograms per liter or more.

#### **Are there other sources of exposure to arsenic?**

In nature, pure arsenic is rare. It is usually combined with other elements to form chemical "compounds." Arsenic in compounds that also contain carbon is called "organic arsenic." Arsenic from plants and animals is usually organic. About two thirds of the small amount of arsenic that occurs in food is organic arsenic.

Arsenic in compounds that do not contain carbon, but contain other elements such as oxygen, chlorine, or sulfur, is called "inorganic arsenic." Most arsenic in soil, rock, and groundwater is inorganic arsenic. Inorganic arsenic is generally more harmful than organic arsenic.

For most people, food and water are the primary sources of exposure to arsenic. Small amounts of arsenic naturally occur in some of the foods we eat, including fish and shellfish, rice, and other cereal products. Fish and shellfish contain mostly organic arsenic, which is the less harmful form. Rice, rice milk, and brown seaweed contain small amounts of inorganic arsenic, the more harmful form. Inorganic arsenic can also be found in some food supplements, such as chitin. It is estimated that most people consume about 50 micrograms of arsenic per day in food and water, with about 5 to 15 micrograms of that typically being inorganic arsenic.

Other ways that people can be exposed to arsenic include: breathing in sawdust or smoke when arsenic-treated wood is cut or burned; applying pesticides or soil supplements that contain arsenic; taking medications that contain arsenic; giving animals medications or treatments that contain arsenic; working in jobs like lead or copper smelting, or pesticide/fertilizer manufacture or application, and; swallowing small amounts of soil containing arsenic while playing or gardening.

### **How can arsenic affect health?**

The health effects of arsenic depend on its chemical form, how much is consumed, and for how long.

A one-time oral dose of 70,000 to 180,000 micrograms of inorganic arsenic is fatal for most people. Although this amount is still quite small, about the weight of a few grains of rice, it is very large compared to the small amounts naturally present in water, soil, food, or air. These small amounts, however, may still cause harm if exposure to them occurs over many years.

### **What are the possible harmful effects of long-term exposure to arsenic?**

Long-term exposure to arsenic can cause a number of harmful effects on the human body. There is increasing evidence that people who consume drinking water with arsenic levels over 100 micrograms per liter for many years can have health problems, including nervous system effects, diabetes, and several circulatory diseases. Arsenic sometimes causes corns (“hyperkeratosis”) to develop on the palms of the hands, the soles of the feet, and other places on the body.

Some studies have now shown that arsenic levels even below 100 micrograms per liter may cause some health problems, including nervous system problems, skin problems, high blood pressure, and reduced intelligence in children. Studies have also linked long term exposure to arsenic in drinking water to increased risk of cancer of the bladder, lungs, liver, and other organs. It is difficult to pinpoint the exact concentration of arsenic in drinking water that can lead to a particular health problem. Individuals differ in their susceptibility to toxic effects. Most information about the toxic effects of arsenic comes from studying groups of people who consumed water containing naturally occurring arsenic over long periods of time. Most studies on arsenic in drinking water and cancer have been conducted in places where the drinking water contained at least several hundred micrograms per liter of arsenic. But even this information is not precise; people drink from a variety of water sources, and the amount of water a person consumes varies over time. It is therefore difficult to know one person’s exact exposure to arsenic in drinking water over time.

Harmful effects from exposure to arsenic in drinking water typically take years to develop. The time required for a condition to develop is related to the amount of arsenic consumed. For example, at high concentrations, darkening of the skin, called “hyperpigmentation,” has been reported after just a few months of exposure, but at lower concentrations, it takes years to develop. Cancers related to arsenic in drinking water typically do not develop for decades. It is not yet clear if an exposure that occurs only for a few years early in life can still cause health effects in adulthood, or whether continuous exposure is necessary to result in health effects later.



### **Does arsenic have any beneficial effects?**

Some limited recent research suggests that some arsenic in the diet, about 12 to 25 micrograms per day, may have a beneficial effect on some chemical processes in the body. This does not change the fact that larger amounts of arsenic can be harmful.

### **What is the standard for arsenic in drinking water?**

The U.S. Environmental Protection Agency (EPA) sets standards, called “Maximum Contaminant Levels” (MCLs) for contaminants in public water systems. In October 2001, EPA established a new standard of 10.0 micrograms per liter for arsenic in drinking water. The previous MCL for arsenic had been 50 micrograms per liter. The MCL is mandatory for community public water systems and is recommended for private well water.

When estimating exposures, EPA uses a drinking water intake of 2 liters per day for adults. Therefore, at the MCL of 10.0 micrograms per liter in water, daily intake of inorganic arsenic from drinking water (about 20 micrograms per day) would typically be higher than daily intake of inorganic arsenic from food. If arsenic levels in drinking water are lower, food may be the greater source of exposure.

When EPA sets an MCL, it considers not only the health risks, but also the cost and technical difficulty of removing the contaminant down to that level. Many public water systems in the United States draw water from sources that have arsenic levels exceeding 10 micrograms per liter. The number of public water systems and the cost of removing arsenic make compliance with the new MCL very costly in some regions. EPA has to balance the scientific studies that show that the MCL is necessary to protect public health over a lifetime of exposure with the costs and technology required to remove arsenic from public water systems. While the MCL for arsenic is low, it is not low enough to completely eliminate all risk of cancer and other health effects. Nevertheless, many other factors, including cigarette smoking and excessive exposure to direct sunlight, also increase the risk of developing these diseases, so risk can be greatly reduced by a generally healthy lifestyle, including a healthy diet, exercise, and not smoking.

MCLs are mandatory for community public water systems. Private drinking water wells are not required to meet federal MCLs or any state drinking water standards. Rather, it is up to each well owner to decide whether he or she wants to take steps to reduce the levels of arsenic in the water. Based on the MCL for public water systems, the Minnesota Department of Health (MDH) recommends that water containing more than 10 micrograms per liter of arsenic not be consumed over the long term. Because arsenic is not easily absorbed through the skin and doesn't evaporate from water, exposure from other uses such as bathing and washing dishes and laundry is minimal.

### **Should I test my private well for arsenic?**

**Yes!** Arsenic in water has no taste or odor, and can occur just about anywhere in Minnesota, so the only way to know if your well water contains arsenic is to have it tested. While well owners are not required to test existing private wells for arsenic, MDH recommends that every well be tested for arsenic at least once. Well owners must arrange and pay for testing their well water for arsenic, which typically costs about \$30-\$40. Make sure that the laboratory you choose is certified by MDH to test drinking water for arsenic. For a list of all laboratories certified by MDH to test drinking water for arsenic go to: [www.health.state.mn.us/labsearch](http://www.health.state.mn.us/labsearch) and click on “Homeowners and the General Public: How to Search for Certified Laboratories.” If you do not have access to a computer, you can call a well specialist at one of the MDH district offices listed at the end of this publication, and they can help you find a laboratory.

State regulations now require licensed water well contractors (and anyone constructing a new well for his or her personal use) to have the water from each new drinking water well tested once for arsenic. The test result must be provided to the well owner before placing the well into service.

If no arsenic is detected in your well water, further testing is usually not necessary. If arsenic is detected at levels above 10 micrograms per liter in a well used for drinking and cooking, and if repeat sampling confirms the results, MDH recommends that you use an alternate source of drinking water or install a treatment system to reduce arsenic levels in the water.

### **What are the best methods for reducing arsenic in drinking water?**

- **Install a water treatment system.**

There are several types of water treatment systems that can effectively reduce arsenic levels in drinking water. These include:

**Specialty Media.** Special removal medias have now been developed by many water treatment companies to specifically remove arsenic from water. They typically use “ferric (iron) hydroxide,” “ferric oxide,” or iron-enhanced ion exchange resins.

**“Reverse Osmosis” systems with pre-oxidation.** Reverse Osmosis (RO) is a water treatment process that removes most dissolved, inorganic contaminants from water by forcing the water through a cellophane-like plastic sheet known as a “semi-permeable membrane.” A pre-oxidation step is usually necessary to convert all arsenic in the water to a removable form. A small counter top RO unit will produce about 3 gallons per day. Slightly larger units that are usually installed under the counter will produce 5 to 20 gallons per day. RO units typically produce only 1 gallon of treated water from every 3 to 5 gallons of water treated. The remaining water goes to waste. The reverse osmosis unit should be checked regularly because the membrane can deteriorate over time.

**Distillation systems.** “Distillation” is a water treatment process that boils water, then cools the steam until it condenses into a separate container. The dissolved contaminants are left behind in the boiling pot. Distillation units require about four hours to produce 1 gallon of water, so this type of treatment uses a considerable amount of energy in its operation.

Remember that while some treatment systems can be useful for other purposes, systems such as conventional water softeners and activated carbon filters will not alone remove arsenic. And boiling the water will only concentrate the arsenic, due to evaporation of some of the water. MDH and the Minnesota Extension Service can provide additional information about selecting a water treatment system.

Before you buy a home water treatment system, make sure that it will meet your needs. Work with a reputable dealer in your area, and learn how the different systems work. Find out how much arsenic the systems will remove, the maintenance requirements, and the costs. MDH recommends that you choose a treatment system that is certified by an independent certifying organization, such as NSF International, Underwriter’s Laboratory (UL), or the Water Quality Association, that tests water treatment systems to assure their effectiveness in living up to the manufacturer’s claims. In Minnesota, water treatment systems must be installed by a licensed and bonded plumbing or water conditioning contractor, although homeowners may install equipment in homes they own and occupy. After the treatment system is installed, it is important to follow the manufacturer’s recommendations for maintaining the system. Also, have the treated water tested periodically to make sure that the treatment system is working properly.

- **Construct a new well.**

In some areas, a new well constructed into a different water-bearing formation may produce water with less natural arsenic. Drilling a new well may be a good option if you already want to replace your existing well for other reasons. It can be less expensive in the long run than maintaining a treatment system. However, a new well may still contain natural arsenic even if the well is properly constructed, and in an appropriate location.

As our information about the occurrence of arsenic grows, we will learn more about which water-bearing formations in an area have higher or lower levels of arsenic. While there will still be no guarantees, the chances of constructing new wells with lower arsenic levels should improve in some areas. For more information about new well construction, contact a licensed water well contractor, or a well specialist at your nearest MDH district office.

- **Connect to a community public water system.**

In some cases, connection to a community public water supply system may be possible. All community public water systems are regularly tested for arsenic and other contaminants and must comply with all EPA standards. Most community public water systems already comply with the new MCL, and all are expected to comply by 2010. Testing results are available from each community public water system.

- **Buy bottled water.**

You may be able to reduce arsenic levels in your drinking water by using bottled water. It is important to note that while all public drinking water systems must meet applicable federal MCLs, no single set of standards applies to all bottled water. Instead, bottled water is subject to a variety of standards, depending on the type of bottled water and where it is bottled. These standards may be more or less stringent than those for public water systems. If you are considering switching to bottled water, be sure that levels of arsenic and other contaminants in the bottled water you choose are lower than levels in water from your current water supply. The bottling company should be able to provide testing results for their water.

### **Should I test my well water for anything else?**

**Bacteria.** Private wells should be tested at least once a year for “coliform” bacteria. Spring is usually a good time to test. It’s also a good idea to test for coliform bacteria any time water changes in taste, odor, or appearance.

**Nitrate.** Well water should also be tested every year or two for nitrate, more frequently if nitrate has been found previously. Always test the water before you start giving it to an infant. Infants under six months of age must not be given water that exceeds the state Health Risk Limit for nitrate (10 milligrams per liter as nitrogen). Boiling water is not a way to remove nitrate from water; it will actually increase the concentration of nitrate in the water.

**Lead.** When water stands idle in the plumbing pipes for more than a few hours, it can absorb lead if the plumbing has old lead pipes, lead-soldered copper pipes, or older brass plumbing components. MDH recommends either: (1) routinely flushing standing water until it feels colder (usually 30-60 seconds) to reduce any lead present, or (2) testing your water for lead after it has been standing in the pipes at least six hours, to see if regular flushing is needed. Also, never use water from hot water faucets for drinking or cooking.

**Other Contaminants.** Other contaminants sometimes occur in private water systems, but much less frequently than bacteria, nitrate, arsenic, or lead. If the well is located close to fuel tanks or to a commercial or industrial area, a test for “volatile organic chemicals,” which are components of fuels, solvents, and cleaners, is a good idea. Agricultural chemicals are sometimes found in wells located near cropped fields or handling areas for agricultural chemicals. Wells that are shallow or in areas of geologic sensitivity (such as fractured limestone) are more vulnerable to contamination by agricultural chemicals than are deep wells. If your well is located in an agricultural area, and especially if it is a shallow well, testing for several of the chemicals most commonly used in the area may be warranted.

**Fluoride.** If children or adolescents are drinking the water, a test for natural levels of fluoride will give your dentist useful information when considering fluoride supplements. A small number of wells in Minnesota (primarily northeastern Minnesota) do exceed the health standard for fluoride, which can cause discoloration of tooth enamel.

**Where can I get more information or help?**

If you have any questions about your well or well water quality, or would like more information, contact a well specialist at your local MDH district office.

# ARSENIC STATE MAP

## Minnesota Department of Health Arsenic Levels of Selected Wells January 2011

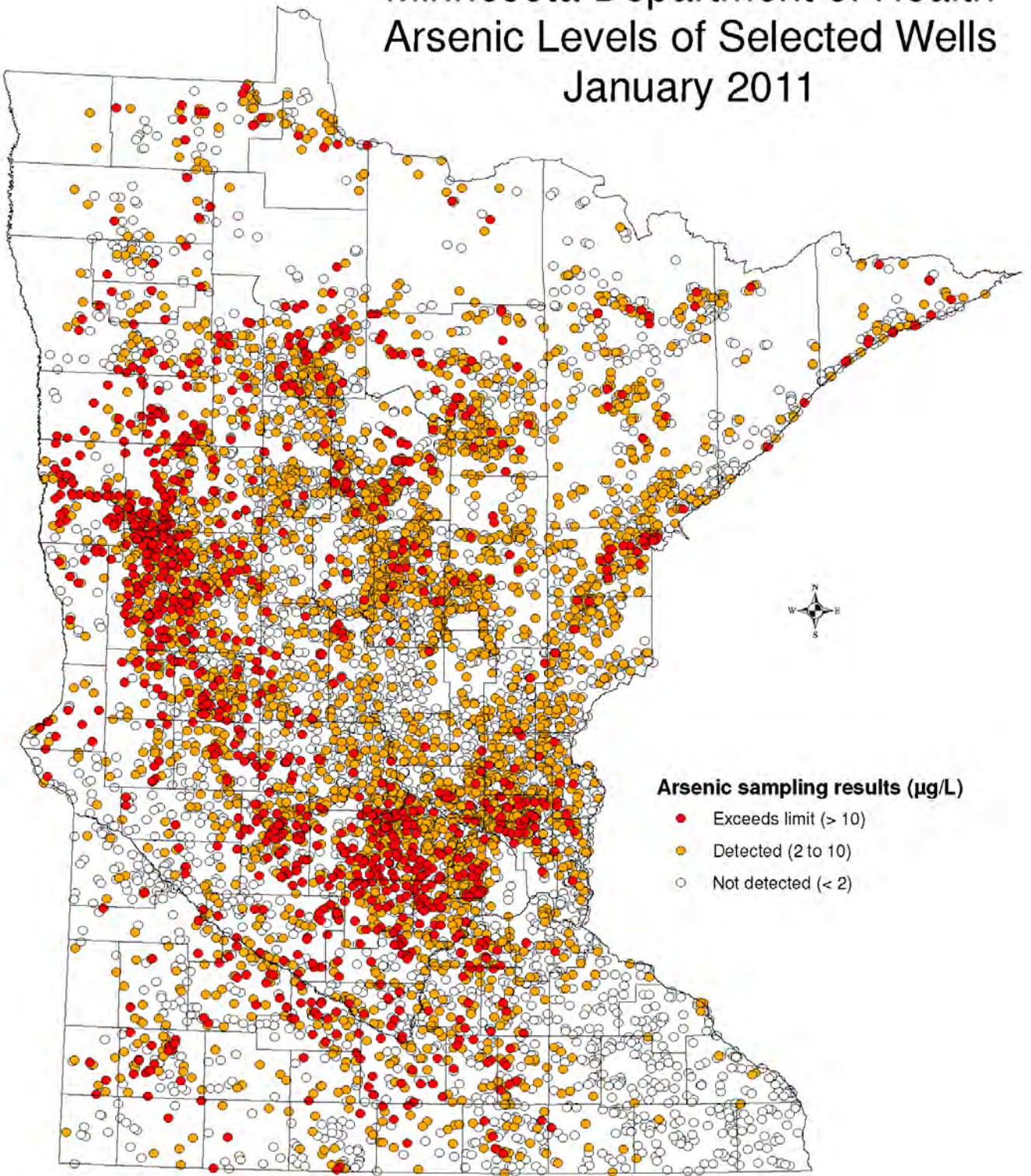

## **COLIFORM BACTERIA**

### **Why test for coliform bacteria?**

It is not practical or economical to routinely test water directly for every possible disease causing bacterium, virus, or protozoan. Instead, water is tested for a group of indicator bacteria which measure the general sanitary quality of the water. These bacteria, called the total coliform group, are common on the surface of the ground and occur in large concentrations in fecal wastes. Testing is relatively easy, quick, safe, and inexpensive.

Most coliform bacteria species do not usually cause disease; however, some waterborne coliform species are capable of causing disease. The total coliform test does not differentiate fecal from non-fecal or pathogenic from non-pathogenic bacteria. If a coliform test shows the presence of coliform bacteria in well water, the well or water system may be contaminated with surface water, human waste, or animal waste, and disease causing organisms may be present. Conversely, if coliform organisms are absent, or have been eliminated by thorough disinfection, it is likely that disease causing organisms are also absent.

### **Can coliform bacteria cause disease?**

The total coliform bacteria group includes approximately 20 different species, primarily from 5 different genera. Four of the genera - Klebsiella, Enterobacter, Citrobacter, and Serratia - are of predominantly environmental origin (soil bacteria). Most species, except for two Klebsiella and one Citrobacter species, are not normally considered primary waterborne pathogens, that is, they do not normally cause disease when consumed in drinking water. One genus, Escherichia Coli (or E. coli), is the primary bacterium in animal and human fecal waste. Its presence in water indicates fecal contamination. A particularly virulent strain of E. coli, called "O157:H7," is capable of causing severe gastroenteritis (nausea, vomiting, and diarrhea), and even death, as evidenced by the outbreak in 2000 in Walkerton, Ontario, and the outbreak in 1999 at the Washington County fair, New York. In both cases, public wells were contaminated with E. coli O157:H7.

While a few strains of coliform bacteria can cause disease, the primary usefulness of the coliform test is as an indicator of contamination. Whether a person contracts a waterborne disease depends on the type or types of organisms present in the water, the number of organisms, and the general health, age, and physical condition of the person. The elderly, infants, and the immune-suppressed are often the most susceptible.

### **What is the difference between total coliform bacteria, fecal coliform, and E. coli?**

As indicted above, total coliform bacteria are a large group of organisms. They are classically defined as "aerobic and facultative anaerobic, gram-negative, non-spore-forming, rod-shaped bacteria that ferment lactose with gas formation within 48 hours at 35 degrees centigrade." They are organisms found in the gastrointestinal tract of warm blooded animals, and therefore in human and animal wastes, and are also common in the soil and in flood waters. "Fecal coliforms" are a subgroup of the total coliform group. They are characterized by their ability to grow at 44.5 degrees centigrade (tolerant of the higher temperatures in the digestive tract of warm-blooded animals), and therefore more indicative of coming from fecal wastes. Escherichia (E) coli is a member of both the total coliform group, and the fecal coliform group. The serotype O157:H7 is one of many strains of E. coli.

### **How widespread is coliform contamination of well water?**

The MDH participated in a Centers for Disease Control (CDC) study of well water quality in nine Midwestern states in 1994. One well was sampled at the center of a grid, every 10 miles across Minnesota, resulting in the sampling of 863 wells. Wells were sampled regardless of age or condition, and ranged from sand-points and old dug wells to new, deep, properly constructed wells. Of the 863 wells sampled, 26.8 percent were positive for total coliform bacteria, and 4.3 percent were positive for fecal coliform. As you might expect, the wells commonly found to have coliform bacteria were old wells, shallow wells, dug wells, and improperly constructed wells. However, some new deep wells also tested positive for coliform bacteria. This study indicated the quality of well water, but did not distinguish between well water quality and groundwater quality. The study indicated that 26.8 percent of the wells were contaminated with total coliform bacteria, but that did not mean that 26.8 percent of the groundwater was contaminated. Most of the coliform problems were due to well defects.

### **How long do coliform bacteria live, and how far do they travel in groundwater?**

The presence of coliform in a well typically means that the bacteria have entered the well recently. Minnesota groundwater and wells are not a particularly hospitable place for bacteria. It is cold, dark, and nutrient limited. One study reported the half life of coliform bacteria in groundwater (the time required for a 50 percent reduction in the bacterial population) to be less than 24 hours. Another study reported 25 percent of coliform organisms to have survived after seven days. The survival time can vary considerably dependant on geology, soil type, temperature, moisture, nutrients, pH, organic matter content, and other conditions, but generally will be measured in terms of days, weeks, or months, as opposed to years.

Coliform movement in groundwater is dependent on survival time plus groundwater flow conditions. Studies have demonstrated a 90 percent removal of coliform from infiltrating sewage water in a few feet of sandy loam soil (although additional travel did not always remove the remaining bacteria). On the other hand, numerous studies have shown coliform to move tens or hundreds of feet in coarse sands, and hundreds or thousands of feet in gravels, fractured rock or cavernous limestone.

Other organisms, such as viruses and some parasites, can live longer and travel farther than coliforms. Also, it is estimated that 50 percent of water-borne disease is not bacterial in nature, but is caused by viruses. Studies in soils have shown that most pathogens are commonly reduced to negligible numbers in two to three months; however, survival times of up to five years have been reported for certain highly resistant (noncoliform) organisms.

In general, the presence of coliform bacteria indicates a relatively recent (hours, days, or weeks) introduction of the bacteria, from a relatively close source, usually within a few hundred feet, and commonly within 50 feet of the well.

### **Does the coliform test give false readings due to iron bacteria or other organisms?**

Generally no. The coliform test does not give a false positive due to mineral bacteria, and only in very limited situations gives a false-positive for other noncoliforms. The genus *Aeromonas* may give a false positive, although it should be noted that *Aeromonas hydrophilia* has been identified as a cause of gastroenteritis. High concentrations of iron may interfere with certain defined substrate (presence/absence) tests, although if iron is present, a control sample should be run. High concentrations of non-coliform organisms may interfere with the membrane filter method and result in a test which is not conclusive, and as a result, a report of "too numerous to count" (TNTC), or "confluent growth" should be given, in which case the well should be disinfected and another sample should be taken.

### **Are coliform and nitrate related?**

Coliform bacteria are small living organisms. Nitrate is a chemical compound of 3 parts oxygen and 1 part nitrogen. They may occur together in groundwater contaminated by human sewage or animal wastes, and they may both enter a well due to improper location or construction. However, they are not directly related. They behave differently in the groundwater, they may result from different sources, and treatment techniques are very different.

### **Why is my coliform test negative and the health department's positive?**

There are three main methods of testing for coliform bacteria; the multiple tube fermentation method, often referred to as "MPN" (most probable number); the membrane filter method, often referred to as "MF;" and defined substrate methods, the most common being "Colilert". The multiple tube fermentation method uses the coliform bacteria's ability to ferment lactose and produce gas. Multiple tubes are filled with water and a nutrient, and heated. Tubes which contain gas indicate the presence of coliform bacteria. The membrane filter method involves pouring the water sample through a filter, adding a selective nutrient to the filter, and waiting for individual bacteria to grow into colonies which are then visually counted. The defined substrate method uses two specific indicator nutrients. When water containing coliform organisms is added to the nutrient-container and incubated for 24 hours, a yellow colored chemical compound is produced. If E. Coli are present, another chemical compound is formed which fluoresces under ultraviolet light. The MDH laboratory uses all three methods, but relies on the substrate method for testing public supplies.

Cases have occurred where a private laboratory MF analysis is negative and the MDH substrate analysis is positive. The substrate method is by most accounts a more sensitive and accurate test method, capable of detecting coliform organisms which would not be detected on the MF test. The nutrients used in the substrate method chemically suppress the growth of other bacteria, while the MF nutrients will encourage the growth of some non-coliforms, which may inhibit coliform growth. The substrate method is also better at culturing chlorine or temperature-stressed organisms. It is also common that samples collected by MDH personnel are tested sooner than other samples, resulting in less bacterial die-off. The MDH substrate positive results signify coliform contamination.

### **Why is it sometimes necessary to disinfect many times before I get a coliform free sample?**

Elimination of bacterial contamination requires an adequate disinfectant, direct contact of the disinfectant with the organism, and sufficient disinfectant concentration and contact time. If any of these criteria are not met, all bacteria may not be eliminated. The amount of disinfectant introduced must exceed the demand of the system. If a well contains mineral bacteria, bacterial slimes, iron, or other oxidizable materials, the disinfectant may be used up before it reaches the coliform bacteria. If the coliform bacteria are hidden among other bacteria, bacterial slimes, drilling mud, iron or other encrustants, bits of wood or other organic material, the disinfectant may again not contact all the bacteria. If the disinfectant does not reach all portions of the well and plumbing system, all bacteria may not be eliminated. Every time a well is disinfected it is important to have sufficient dosage, contact, and contact time. When a problem well is disinfected, it may be necessary to control the system pH, circulate the disinfectant through the entire water system, and in severe cases, scrub or otherwise clean the casing, and use other chemical or physical treatment.

It is rare that an aquifer is contaminated with coliform bacteria. Cavernous limestone, fractured rock, or surficial gravels are the usual exceptions. It is not rare that a well is contaminated. Common causes of contamination are: inadequately chlorinated drilling water; soil organisms carried down the hole during drilling or repair; soil organisms mixed into the drilling mud and forced into the formation or used as "grout"; defective casing (usually near the surface), pitless, caps, or seals; and generally poor sanitation. Increasingly, attention has turned to problems encountered with new rotary drilled wells that require



repeated disinfections to obtain a coliform-free sample. It is thought that the problem is due to soil bacteria mixed into the drilling mud and forced into the formation during the drilling of the well, or mixed with the cuttings and emplaced in the annular space. The normal good practices of using chlorinated drilling water and drilling mud, keeping tools and equipment clean, and adequately developing and disinfecting should be followed. If these do not consistently produce coliform free water, other techniques can be used, including: the use of a short surface casing to case off the active zone of soil contamination; replacing the initial drilling mud with fresh drilling mud once the surface soils have been drilled; flushing and chlorinating the annular space after the hole is drilled and prior to grouting; or eliminating the use of drilling fluid and cuttings as an annular space seal.

## NITRATE

Nitrate is a common contaminant found in many wells in Minnesota. Too much nitrate in drinking water can cause serious health problems for young infants. This brochure provides a basic explanation of nitrate in wells and gives steps that you as a well owner can take to protect your family and visitors from illness.

### **What is nitrate?**

Nitrate ( $\text{NO}_3$ ) is a naturally occurring chemical made of nitrogen and oxygen. Nitrate is found in air, soil, water, and plants. Much of the nitrate in our environment comes from decomposition of plants and animal wastes. People also add nitrate to the environment in the form of fertilizers.

### **How does nitrate get into well water?**

Natural levels of nitrate in Minnesota groundwater are usually quite low (less than 1 milligram per liter [mg/L] of nitrate-nitrogen). However, where sources of nitrate such as fertilizers, animal wastes, or human sewage are concentrated near the ground surface, nitrate may seep down and contaminate the groundwater. Elevated nitrate levels in groundwater are often caused by run-off from barnyards or feedlots, excessive use of fertilizers, or septic systems.

Wells most vulnerable to nitrate contamination include shallow wells, dug wells with casing which is not watertight, and wells with damaged, leaking casing or fittings.

Nitrate contamination of a well is often regarded as a first sign of deteriorating groundwater quality.

### **What are the health risks of nitrate in well water?**

Too much nitrate in drinking water poses a risk to infants under six months of age. If an infant is fed water or formula made with water that is high in nitrate, a condition called "blue baby syndrome" (or "methemoglobinemia") can develop. Bacteria which are present in an infant's stomach can convert nitrate to nitrite ( $\text{NO}_2$ ), a chemical which can interfere with the ability of the infant's blood to carry oxygen. As the condition worsens, the baby's skin turns a bluish color, particularly around the eyes and mouth. If nitrate levels in the water are high enough and prompt medical attention is not received, death can result.

### **Why are young infants more susceptible?**

As an infant ages, its stomach acidity increases, reducing the numbers of nitrite-producing bacteria. After six months, the conversion of nitrate to nitrite in the stomach no longer occurs. Most adults can consume large amounts of nitrate with no ill effects. In fact, the average adult in the U.S. consumes about 20-25 milligrams of nitrate-nitrogen every day in food, largely from vegetables.

Pregnant women, people with reduced stomach acidity, and people with certain blood disorders may also be susceptible to nitrate-induced methemoglobinemia. Some research has suggested that nitrate may also play a role in the development of some cancers. However, at this time there is no clear evidence that nitrate ingestion results in an increased cancer risk.

### **How much nitrate is too much?**

The state Health Risk Limit for nitrate is 10 mg/L of nitrate-nitrogen, which provides newborns with reasonable protection against blue baby syndrome. This level is mandatory for all public water systems, and recommended for private wells.

### **How do I know if my well water has nitrate?**

Nitrate is tasteless, odorless, and colorless. To find out if there is nitrate in your water, have it tested by a laboratory that is certified for nitrate testing by the Minnesota Department of Health (MDH). Laboratories will provide sampling bottles and instructions. The price for the test typically ranges from \$15 to \$35. Contact your local health department, find a certified lab on the MDH Web site at: [www.health.state.mn.us/labsearch](http://www.health.state.mn.us/labsearch) or look in the Yellow Pages under “Laboratories – Testing” or “Water Analysis” for a certified laboratory serving your area.

### **How often should I have my well tested for nitrate?**

It’s a good idea to have a routine nitrate test every two or three years, more frequently if nitrate has been detected in previous samples or is increasing in concentration. State regulations require well contractors to have a water sample tested for bacteria and nitrate when they construct a new well. After that, owners of private wells must arrange for their own water testing.

You should also have your water tested for nitrate if you are a woman planning on becoming pregnant or if infants will be using the water.

### **What if nitrate is found in my water?**

- 1. If the nitrate-nitrogen concentration exceeds the health limit of 10 mg/L, do not give the water to any infant under six months of age**, either directly or in formula. Infants should be provided with water from a source which has been tested and shown to be low in nitrate and bacterially safe. Commercially bottled water is required to meet the nitrate standard, and can be given to infants.
- 2. Do not boil to “treat” high nitrate water.** Nitrate is not removed from the water by boiling. Boiling actually concentrates the nitrate, due to evaporation of the water.
- 3. Have your well inspected.** It is a good idea to have your well inspected by a licensed well contractor if the well is old, or you do not know if it is structurally sound. Nitrate and bacteria problems are sometimes caused by structural flaws which allow contaminated surface water to enter the well. Repairing the well or constructing a new, deeper well often results in a significant reduction in the nitrate level. To find a contractor, look in the Yellow Pages under “*Well Drilling and Service.*” The MDH also has a list of licensed well contractors on the MDH Well Management Section Web site at: [www.health.state.mn.us/divs/eh/wells/lwc](http://www.health.state.mn.us/divs/eh/wells/lwc)
- 4. Identify and remove sources of nitrate near the well.** Fertilizers, animal wastes, and sewage systems should be located and managed so that they do not contaminate the well. If a nitrate source is too close to the well and cannot be moved, then you may need to consider having the well permanently sealed and replaced by a licensed well contractor.

### **What about a water treatment unit?**

Home water treatment units are not recommended for treating high nitrate water which will be given to infants. There is no foolproof way of knowing when the treatment system may fail, and blue baby syndrome has been known to occur after just one day of exposure to high nitrate water.

### **Should I test my well for anything other than nitrate?**

**Yes.** Private wells should be tested at least once a year for **bacterial safety, by testing for total coliform bacteria**. It is also wise to test well water for bacteria any time the water changes in taste, odor, or appearance. A brochure on *Bacterial Safety of Well Water* is available from the MDH.

In addition, water can absorb **lead** from old lead pipes, lead-soldered copper pipes, or brass plumbing components, when the water stands idle in the pipes for more than a few hours. It is recommended to either **flush standing water** until you feel the water get colder (usually 30-60 seconds), or **have your water tested for lead** after it has been standing in the pipes at least six hours. Also, never use water from hot water faucets for drinking or cooking. A brochure, *Lead in Well Water Systems*, is available from the MDH.

**Arsenic** occurs naturally in about half the wells in Minnesota, and about 10 percent of wells produce water which exceeds 10 micrograms per liter (parts per billion), the federal drinking water standard. Arsenic is more prevalent in western Minnesota, but can occur almost anywhere in the state.

Long-term consumption of arsenic above the drinking water standard may increase the risk of health problems of the skin, circulatory system, nervous system, lungs, and bladder, including some forms of cancer. Every private well should be tested at least once or twice to determine if arsenic is present in the water. A brochure, *Arsenic in Drinking Water*, is available from the MDH.

Other contaminants sometimes occur in private water systems, but much less frequently than bacteria, nitrate, arsenic, or lead. If the well is located close to fuel tanks or a commercial or industrial area, a test for **“volatile organic chemicals”** (VOCs) is a good idea. A brochure, *VOCs*, is available from the MDH. **Agricultural chemicals** are sometimes found in wells located near cropped fields or handling areas for agricultural chemicals. Shallow wells are more vulnerable to pesticide contamination than are deep wells. If your well is located in an agricultural area, and especially if it is a shallow well, testing for several of the pesticides most commonly used in the area may be warranted.

If children or adolescents are drinking the water, a test for natural levels of **fluoride** will give your dentist useful information when considering fluoride supplements. A small number of wells in Minnesota (primarily northeastern Minnesota) do have naturally-occurring levels of fluoride that exceed the health standard.

### **Where can I get more information?**

If you have any questions about your well or well water quality, or would like more information, contact your nearest MDH office and ask to speak with a well specialist.

## TESTING FOR OTHER CONTAMINANTS

### **Should I be concerned about things other than arsenic, coliform bacteria, and nitrate in my drinking water?**

Although private well water in Minnesota is most commonly tested for coliform bacteria, nitrate and arsenic, there are other contaminants that may be of concern under some circumstances:

**Lead.** When water stands idle in the plumbing pipes for more than a few hours, it can absorb lead if the plumbing has old lead pipes; lead soldered copper pipes, or older brass plumbing components such as valves or faucets. Where such plumbing is known or suspected to exist, the MDH recommends that either: (1) the standing water be flushed to waste until the water feels colder (usually 30-60 seconds); or (2) the water be tested for lead after it has been standing in the pipes at least six hours. Also, never use water from hot water faucets for drinking or cooking because lead dissolves more readily in hot water.

**Volatile Organic Chemicals (VOCs).** If the well is located close to fuel tanks or to a commercial or industrial area, a test for volatile organic chemicals may be a good idea.

**Pesticides or herbicides** are sometimes found in wells located near cropped fields or handling areas for agricultural chemicals. Shallow wells are more vulnerable to pesticide contamination than are deep wells. If your well is located in an agricultural area, and especially if it is a shallow well, testing for several of the pesticides most commonly used in the area may be warranted.

**Fluoride.** If children or adolescents are drinking the water, a test for natural levels of fluoride will give your dentist useful information when considering fluoride supplements. A small number of wells in Minnesota (primarily northeastern Minnesota) do exceed the health standard for fluoride, which can cause discoloration of tooth enamel.

**E. coli, giardia, and other organisms.** The total coliform test is a good indicator of the health-related microbiological quality of water. Other tests are not normally needed. Instances where a test for fecal coliform or E. coli may be warranted are after repeated total coliform positives, after a well has been flooded, or if there is suspicion of defective casing or of fecal contamination.

The 1993 cryptosporidium outbreak in Milwaukee, which took an estimated 104 lives and sickened 400,000 people, has resulted in an increased number of requests for testing of private wells for cryptosporidium. Likewise, media attention on giardia in drinking water has increased requests for giardia testing. While it is possible for both organisms to enter the groundwater and reach a well, their relatively large size prevents their easy movement through most soils, and the number of confirmed cases of either cryptosporidium or giardia in well water is extremely small. The Milwaukee water source is not well water, but surface water from Lake Michigan, where a number of factors resulted in the outbreak. Testing for cryptosporidium or giardia in water is very difficult and expensive. Local laboratories, including the MDH lab, do not routinely test for these organisms. Testing for these organisms in well water would only be recommended if the organisms have been confirmed in an infected individual, other sources of infection have been eliminated, and the well appears extremely vulnerable to contamination.

## HEALTH-BASED RULES AND GUIDANCE FOR GROUNDWATER

<p><b><u>Value Type Key:</u></b></p>	<p>HRL = <a href="#">Health Risk Limits</a>            HBV = <a href="#">Health-Based Values</a>            RAA = <a href="#">Risk Assessment Advice</a></p> <p>Numerical subscripts indicate the year the value was developed. MCL denotes a HRL based on a US EPA Maximum Contaminant Level.</p>
--------------------------------------	--

<p><b>Duration Key:</b></p>	<p>Acute = one day exposure            Short-term = greater than one day up to 30 days            Subchronic = greater than 30 days up to 10% of a lifetime            Chronic = greater than 10% of a lifetime</p>
-----------------------------	---

--	--	--	--	--	--	--	--	--	--

CAS Number	Chemical	Value Type	Exposure Duration	Value (µg/L)	Health Endpoint(s)
83-32-9	Acenaphthene	HRL <sub>93</sub>	Chronic	400	Liver system
34256-82-1	<a href="#">Acetochlor</a>  <i>See also degradates:</i> <a href="#">Acetochlor ESA</a> <a href="#">Acetochlor OXA</a>	HRL <sub>08</sub>	Acute	40	Developmental
			Short-term	40	Developmental
			Subchronic	40*	Developmental
			Chronic	9	Liver system; Male reproductive system; Nervous system; Kidney system; Respiratory system
			Cancer	NA	--
187022-11-3	<a href="#">Acetochlor ESA</a>  (degradate of <a href="#">Acetochlor</a> )	HBV <sub>09</sub>	Acute	ND	--
			Short-term	600	Thyroid (E)
			Subchronic	600	Thyroid (E)
			Chronic	300	Thyroid (E)
			Cancer	NA	--
184992-44-4	<a href="#">Acetochlor OXA</a>  (degradate of <a href="#">Acetochlor</a> )	HBV <sub>09</sub>	Acute	ND	--
			Short-term	200	Thyroid (E)
			Subchronic	200	Thyroid (E)
			Chronic	100	Thyroid (E)
			Cancer	NA	--
67-64-1	Acetone	HRL <sub>93</sub>	Chronic	700	Kidney system
15972-60-8	<a href="#">Alachlor</a>	HRL <sub>08</sub>	Acute	ND	--
			Short-term	200	Kidney system

	<i>See also</i> degradates <a href="#">Alachlor ESA</a> <a href="#">Alachlor OXA</a>		Subchronic	30	Blood system; Liver system
			Chronic	5	Blood system; Liver system
			Cancer	NA	--
142363-53-9	<a href="#">Alachlor ESA</a>  (degradate of <a href="#">Alachlor</a> )	RAA <sub>09</sub>	Acute	ND	--
			Short-term	ND	--
			Subchronic	100	Hematological (blood) system
			Chronic	70	Hematological (blood) system
			Cancer	NA	--
171262-17-2	<a href="#">Alachlor OXA</a>  (degradate of <a href="#">Alachlor</a> )	RAA <sub>09</sub>	Acute	ND	--
			Short-term	ND	--
			Subchronic	100	Hematological (blood) system
			Chronic	70	Hematological (blood) system
			Cancer	NA	--
116-06-3	Aldicarb	HRL <sub>93</sub>	Chronic	1	Nervous system
107-05-1	Allyl chloride (3 chloropropene)	HRL <sub>94</sub>	Chronic	30	Nervous system
120-12-7	Anthracene	HRL <sub>93</sub>	Chronic	2,000	None
7440-36-0	Antimony	HRL <sub>93</sub>	Chronic	6	--
1912-24-9	Atrazine	HRL <sub>MCL</sub>	Chronic	3	<a href="#">see USEPA Organic Chemicals table</a>
7440-39-3	Barium	HRL <sub>93</sub>	Chronic	2,000	Cardiovascular system
71-43-2	<a href="#">Benzene</a>	HRL <sub>08</sub>	Acute	10	Developmental
			Short-term	10	Blood system; Immune system
			Subchronic	3	Blood system; Immune system
			Chronic	3**	Blood system; Immune system
			Cancer	2	Cancer
65-85-0	Benzoic acid	HRL <sub>93</sub>	Chronic	30,000	None
7440-41-7	Beryllium	HRL <sub>93</sub>	Cancer	0.08	Cancer
92-52-4	1,1-Biphenyl (Diphenyl)	HRL <sub>93</sub>	Chronic	300	Kidney system
111-44-4	Bis(chloroethyl) ether (BCEE)	HRL <sub>93</sub>	Cancer	0.3	Cancer
542-88-1	Bis(chloromethyl) ether (BCME)	HRL <sub>93</sub>	Cancer	0.002	Cancer
7440-42-8	<a href="#">Boron</a>	RAA	Chronic	1,000	Developmental
75-27-4	Bromodichloromethane	HRL <sub>93</sub>	Cancer	6	Cancer
75-25-2	Bromoform	HRL <sub>93</sub>	Cancer	40	Cancer
74-83-9	Bromomethane (Methyl bromide)	HRL <sub>93</sub>	Chronic	10	Gastrointestinal system

71-36-3	n-Butanol	HRL <sub>93</sub>	Chronic	700	Nervous system
85-68-7	Butyl benzyl phthalate	HRL <sub>93</sub>	Chronic	100	None
85-70-1	Butylphthalyl butylglycolate (BPBG)	HRL <sub>93</sub>	Chronic	7,000	None
7440-43-9	Cadmium	HRL <sub>93</sub>	Chronic	4	Kidney system
75-15-0	Carbon disulfide	HRL <sub>93</sub>	Chronic	700	Developmental
56-23-5	Carbon tetrachloride	HRL <sub>93</sub>	Cancer	3	Cancer
133-90-4	Chloramben	HRL <sub>94</sub>	Chronic	100	Liver system
108-90-7	Chlorobenzene	HRL <sub>93</sub>	Chronic	100	Liver system
67-66-3	<a href="#">Chloroform</a>	HRL <sub>08</sub>	Acute	ND	--
			Short-term	30	Developmental; Liver system; Immune system
			Subchronic	30*	Developmental; Liver system; Immune system; Male reproductive system
			Chronic	30*	Developmental; Liver system; Immune system; Male reproductive system
			Cancer	NA	--
95-57-8	2-Chlorophenol	HRL <sub>93</sub>	Chronic	30	Developmental
1897-45-6	Chlorothalonil	HRL <sub>94</sub>	Cancer	30	Cancer
16065-83-1	Chromium III	HRL <sub>94</sub>	Chronic	20,000	None
18540-29-9	Chromium VI	HRL <sub>93</sub>	Chronic	100	None
98-82-8	Cumene (Isopropyl benzene) <sup>1</sup>	HRL <sub>93</sub>	Chronic	300	None
21725-46-2	<a href="#">Cyanazine</a>	HRL <sub>08</sub>	Acute	2	Development effects
			Short-term	2	Development effects
			Subchronic	2	Liver system; Kidney system
			Chronic	1	None
			Cancer	NA	--
57-12-5	Cyanide, free	HRL <sub>93</sub>	Chronic	100	Nervous system; Thyroid (E)
124-48-1	Dibromochloromethane	HRL <sub>93</sub>	Chronic	10	Liver system
106-93-4	1,2-Dibromoethane (ethylene dibromide, EDB)	HRL <sub>93</sub>	Cancer	0.004	Cancer
84-74-2	Dibutyl phthalate	HRL <sub>93</sub>	Chronic	700	None
1918-00-9	Dicamba	HRL <sub>93</sub>	Chronic	200	Developmental
95-50-1	1,2-Dichlorobenzene	HRL <sub>93</sub>	Chronic	600	Liver system
106-46-7	1,4-Dichlorobenzene (para)	HRL <sub>94</sub>	Cancer	10	Cancer
91-94-1	3,3'-Dichlorobenzidine	HRL <sub>93</sub>	Cancer	0.8	Cancer
75-71-8	<a href="#">Dichlorodifluoromethane</a>	HBV <sub>09</sub>	Acute	ND	--



			Short-term	ND	--
			Subchronic	ND	--
			Chronic	700	None
			Cancer	NA	--
72-54-8	p,p'-Dichlorophenyldichloroethane (DDD)	HRL <sub>93</sub>	Cancer	1	Cancer
72-55-9	p,p'-Dichlorodipenyldichloroethylene (DDE)	HRL <sub>93</sub>	Cancer	1	Cancer
50-29-3	p,p'-Dichlorodiphenyltrichloroethane (DDT)	HRL <sub>93</sub>	Cancer	1	Cancer
75-34-3	<a href="#">1,1-Dichloroethane</a> (	RAA <sub>09</sub>	Acute	ND	--
			Short-term	500	Nervous system
			Subchronic	500*	Nervous system
			Chronic	100	Nervous system
			Cancer	NA	--
107-06-2	1,2-Dichloroethane	HRL <sub>93</sub>	Cancer	4	Cancer
75-35-4	<a href="#">1,1-Dichloroethylene (Vinylidene chloride)</a>	HBV <sub>09</sub>	Acute	ND	--
			Short-term	ND	--
			Subchronic	200	Liver system
			Chronic	200	Liver system
			Cancer	NA	--
156-59-2	<a href="#">cis-1,2-Dichloroethylene</a>	HRL <sub>08</sub>	Acute	ND	--
			Short-term	70	Blood system
			Subchronic	70*	Blood system
			Chronic	50	Blood system
			Cancer	NA	--
156-60-5	Trans-1,2-Dichloroethylene	HRL <sub>93</sub>	Chronic	100	None
75-09-2	Dichloromethane (Methylene chloride)	HRL <sub>MCL</sub>	Chronic	5	<a href="#">see USEPA Organic Chemicals table</a>
120-83-2	2,4-Dichlorophenol	HRL <sub>93</sub>	Chronic	20	Immune system
94-75-7	2,4-Dichlorophenoxyacetic acid (2,4-D)	HRL <sub>93</sub>	Chronic	70	Blood system; Liver system; Kidney system
78-87-5	1,2-Dichloropropane	HRL <sub>94</sub>	Cancer	5	Cancer
542-75-6	1,3-Dichloropropene	HRL <sub>94</sub>	Cancer	2	Cancer
60-57-1	<a href="#">Dieldrin</a>	HRL <sub>08</sub>	Acute	0.2	Developmental
			Short-term	0.2	Developmental; Immune system; Nervous system
			Subchronic	0.2*	Developmental; Immune system; Nervous system
			Chronic	0.2	Liver system; Nervous system
			Cancer	0.006	Cancer

117-81-7	Di(2-ethylhexyl)phthalate (DEHP)	HRL <sub>MCL</sub>	Chronic	6	<a href="#">see USEPA Organic Chemicals table</a>
84-66-2	Diethyl phthalate	HRL <sub>93</sub>	Chronic	6,000	None
105-67-9	2,4-Dimethylphenol	HRL <sub>93</sub>	Chronic	100	Blood system; Nervous system
131-11-3	Dimethylphthalate	HRL <sub>94</sub>	Chronic	70,000	Kidney system
51-28-5	2,4-Dinitrophenol	HRL <sub>94</sub>	Chronic	10	Eyes
298-04-4	Disulfoton	HRL <sub>94</sub>	Chronic	0.3	Nervous system
100-41-4	Ethylbenzene	HRL <sub>93</sub>	Chronic	700	Liver system; Kidney system
759-94-4	S-Ethyl dipropylthiocarbamate (EPTC)	HRL <sub>93</sub>	Chronic	200	Cardiovascular system; Nervous system
60-29-7	Ethyl ether	HRL <sub>93</sub>	Chronic	1,000	None
107-21-1	Ethylene glycol	HRL <sub>94</sub>	Chronic	10,000	Kidney system
206-44-0	Fluoranthene	HRL <sub>93</sub>	Chronic	300	Liver system; Kidney system
86-73-7	Fluorene (9H-Fluorene)	HRL <sub>93</sub>	Chronic	300	Blood system
50-00-0	Formaldehyde	HRL <sub>94</sub>	Chronic	1,000	Gastrointestinal system
76-44-8	Heptachlor	HRL <sub>93</sub>	Cancer	0.08	Cancer
1024-57-3	Heptachlor epoxide	HRL <sub>93</sub>	Cancer	0.04	Cancer
118-74-1	Hexachlorobenzene	HRL <sub>93</sub>	Cancer	0.2	Cancer
87-68-3	Hexachlorobutadiene	HRL <sub>93</sub>	Chronic	1	Kidney system
110-54-3	Hexane (n-hexane)	HRL <sub>94</sub>	Chronic	400	Nervous system
78-59-1	Isophorone	HRL <sub>93</sub>	Chronic	100	Kidney system
330-55-2	Linuron	HRL <sub>93</sub>	Chronic	1	Blood system
7439-96-5	<a href="#">Manganese</a>	RAA	Chronic	300	Nervous system
67-56-1	Methanol	HRL <sub>94</sub>	Chronic	3,000	Liver system; Nervous system
94-74-6	2-Methyl-4-chlorophenoxyacetic acid (MCPA)	HRL <sub>93</sub>	Chronic	3	Liver system; Kidney system
78-93-3	Methyl ethyl ketone (MEK, 2-butanone)	HRL <sub>94</sub>	Chronic	4,000	Developmental
108-10-1	Methyl isobutyl ketone (MIBK)	HRL <sub>94</sub>	Chronic	300	Liver system; Kidney system
95-48-7	2-Methylphenol (o-cresol)	HRL <sub>93</sub>	Chronic	30	Nervous system
108-39-4	3-Methylphenol (m-cresol)	HRL <sub>93</sub>	Chronic	30	Nervous system
106-44-5	4-Methylphenol (p-cresol)	HRL <sub>94</sub>	Chronic	3	None
51218-45-2	<a href="#">Metolachlor</a>  <i>See also degrades</i> <a href="#">Metolachlor ESA</a> <a href="#">Metolachlor OXA</a>	HBV <sub>09</sub>	Acute	400	Developmental
			Short-term	400	Developmental
			Subchronic	300	None
			Chronic	300	None
			Cancer	NA	--
171118-	<a href="#">Metolachlor ESA</a>	HBV <sub>09</sub>	Acute	ND	--

09-5	(degradate of <a href="#">Metolachlor</a> )		Short-term	ND	--
			Subchronic	4,000	Liver system
			Chronic	800	Liver system
			Cancer	NA	--
152019-73-3	<a href="#">Metolachlor OXA</a> (degradate of <a href="#">Metolachlor</a> )	HBV <sub>09</sub>	Acute	ND	--
			Short-term	3,000	None
			Subchronic	3,000*	None
			Chronic	800	None
			Cancer	NA	--
21087-64-9	Metribuzin	HRL <sub>93</sub>	Chronic	200	Liver system; Kidney system
91-20-3	Naphthalene	HRL <sub>94</sub>	Chronic	300	None
7440-02-0	Nickel, soluble salts	HRL <sub>93</sub>	Chronic	100	None
14797-55-8	Nitrate (as nitrogen)	HRL <sub>MCL</sub>	Acute	10,000	<a href="#">see USEPA Inorganic Chemicals table</a>
86-30-6	N-Nitrosodiphenylamine	HRL <sub>93</sub>	Cancer	70	Cancer
87-86-5	Pentachlorophenol	HRL <sub>MCL</sub>	Chronic	1	<a href="#">see USEPA Organic Chemicals table</a>
375-22-4	<a href="#">Perfluorobutyrate (PFBA)</a> (	HBV	Acute	8	Developmental
			Short-term	7	Developmental; Liver system; Thyroid (E)
			Subchronic	7*	Developmental; Liver system; Thyroid (E)
			Chronic	7*	Developmental; Liver system; Thyroid (E)
			Cancer	NA	--
335-67-1; 335-66-0; 3825-26-1; 2395-00-8; 335-93-3; 335-95-5	<a href="#">Perfluorooctanoic Acid (PFOA) and Salts</a>	HRL <sub>08</sub>	Acute	ND	--
			Short-term	ND	--
			Subchronic	ND	--
			Chronic	0.3	Development effects; Liver system; Immune system
			Cancer	NA	
1763-23-1; 29081-56-9; 70225-14-8; 2795-39-3; 29457-72-5	<a href="#">Perfluorooctane Sulfonate (PFOS) and Salts</a> (	HRL <sub>08</sub>	Acute	ND	--
			Short-term	ND	--
			Subchronic	ND	--
			Chronic	0.3	Development effects; Liver system; Thyroid (E)
			Cancer	NA	--

108-95-2	Phenol	HRL <sub>93</sub>	Chronic	4,000	Developmental
1918-02-1	Picloram	HRL <sub>93</sub>	Chronic	500	Liver system
1336-36-3	Polychlorinated biphenyls (PCBs)	HRL <sub>94</sub>	Cancer	0.04	Cancer
1610-18-0	Prometon	HRL <sub>93</sub>	Chronic	100	None
1918-16-7	Propachlor	HRL <sub>93</sub>	Chronic	90	None
129-00-0	Pyrene	HRL <sub>93</sub>	Chronic	200	Kidney system
7782-49-2	Selenium	HRL <sub>93</sub>	Chronic	30	None
7440-22-4	Silver	HRL <sub>93</sub>	Chronic	30	None
122-34-9	Simazine	HRL <sub>MCL</sub>	Chronic	4	<a href="#">see USEPA Organic Chemicals table</a>
630-20-6	1,1,1,2-Tetrachloroethane	HRL <sub>93</sub>	Chronic	70	Kidney system; Liver system
79-34-5	1,1,2,2-Tetrachloroethane	HRL <sub>94</sub>	Cancer	2	Cancer
127-18-4	1,1,2,2-Tetrachloroethylene (PERC)	HRL <sub>MCL</sub>	Chronic	5	<a href="#">see USEPA Organic Chemicals table</a>
7440-28-0	Thallium salts	HRL <sub>94</sub>	Chronic	0.6	Liver system
7440-31-5	Tin	HRL <sub>94</sub>	Chronic	4,000	Liver system; Kidney system
108-88-3	Toluene	HRL <sub>93</sub>	Chronic	1,000	Liver system; Kidney system
8001-35-2	Toxaphene	HRL <sub>93</sub>	Cancer	0.3	Cancer
71-55-6	<a href="#">1,1,1-Trichloroethane</a> )	HRL <sub>08</sub>	Acute	ND	--
			Short-term	ND	--
			Subchronic	20,000	Liver system; Male reproductive system
			Chronic	9,000	Liver system; Male reproductive system
			Cancer	NA	
79-00-5	1,1,2-Trichloroethane	HRL <sub>93</sub>	Chronic	3	Immune system
79-01-6	1,1,2-Trichloroethylene (TCE)	HRL <sub>MCL</sub>	Chronic	5	<a href="#">see USEPA Organic Chemicals table</a>
75-69-4	Trichlorofluoromethane	HRL <sub>93</sub>	Chronic	2,000	None
88-06-2	2,4,6-Trichlorophenol	HRL <sub>93</sub>	Cancer	30	Cancer
93-76-5	2,4,5-Trichlorophenoxyacetic acid	HRL <sub>93</sub>	Chronic	70	Developmental; Blood system
93-72-1	2-(2,4,5-Trichlorophenoxy) propionic acid	HRL <sub>MCL</sub>	Chronic	50	<a href="#">see USEPA Organic Chemicals table</a>
96-18-4	1,2,3-Trichloropropane	HRL <sub>93</sub>	Chronic	40	Liver system; Kidney system

76-13-1	1,1,2-Trichloro-1,2,2-trifluoroethane	HRL <sub>93</sub>	Chronic	200,000	None
108-67-8	<a href="#">1,3,5-Trimethylbenzene</a>	HRL <sub>08</sub>	Acute	ND	--
			Short-term	100	Liver system
			Subchronic	100*	Liver system; Kidney system
			Chronic	100*	Liver system; Kidney system
			Cancer	NA	--
99-35-4	1,3,5-Trinitrobenzene	HRL <sub>93</sub>	Chronic	0.3	None
7440-62-2	Vanadium	HRL <sub>94</sub>	Chronic	50	None
75-01-4	<a href="#">Vinyl Chloride</a>	HRL <sub>08</sub>	Acute	ND	--
			Short-term	ND	--
			Subchronic	80	Liver system
			Chronic	10	Liver system
			Cancer	0.2	Cancer
1330-20-7	Xylenes (mixture of isomers, o, m, p)	HRL <sub>93</sub>	Chronic	10,000	Nervous system
7440-66-6	Zinc	HRL <sub>94</sub>	Chronic	2,000	None

NA - Not Applicable

ND - Not derived due to insufficient information

None - Nonspecific effects that could not be attributed to an organ system

(E) = Endocrine mediated effect on the specified target organ

\*Set at short-term HRL

\*\*Set at subchronic HRL

<sup>1</sup> Chemical to be reviewed and is likely to change.

**ENVIRONMENTAL PROTECTION AGENCY**

**LIST OF ORGANIC DRINKING WATER CONTAMINANTS AND THEIR MAXIMUM CONTAMINANT LEVELS (MCL's) FOR PUBLIC WATER SUPPLIES**

(US EPA Organic Chemicals Table referenced in the Health Based Rules and Guidance Table Above)

Organic Chemicals

<b>Contaminant</b>	<b>MCLG (mg/L)</b>	<b>MCL or TT (mg/L)</b>	<b>Potential Health Effects from Ingestion of Water</b>	<b>Sources of Contaminant in Drinking Water</b>
<a href="#"><u>Acrylamide</u></a>	zero	TT	Nervous system or blood problems; increased risk of cancer	Added to water during sewage/wastewater treatment
<a href="#"><u>Alachlor</u></a>	zero	0.002	Eye, liver, kidney or spleen problems; anemia; increased risk of cancer	Runoff from herbicide used on row crops
<a href="#"><u>Atrazine</u></a>	0.003	0.003	Cardiovascular system or reproductive problems	Runoff from herbicide used on row crops
<a href="#"><u>Benzene</u></a>	zero	0.005	Anemia; decrease in blood platelets; increased risk of cancer	Discharge from factories; leaching from gas storage tanks and landfills
<a href="#"><u>Benzo(a)pyrene (PAHs)</u></a>	zero	0.0002	Reproductive difficulties; increased risk of cancer	Leaching from linings of water storage tanks and distribution lines
<a href="#"><u>Carbofuran</u></a>	0.04	0.04	Problems with blood, nervous system, or reproductive system	Leaching of soil fumigant used on rice and alfalfa
<a href="#"><u>Carbon tetrachloride</u></a>	zero	0.005	Liver problems; increased risk of cancer	Discharge from chemical plants and other industrial activities
<a href="#"><u>Chlordane</u></a>	zero	0.002	Liver or nervous system problems; increased risk of cancer	Residue of banned termiticide

<a href="#">Chlorobenzene</a>	0.1	0.1	Liver or kidney problems	Discharge from chemical and agricultural chemical factories
<a href="#">2,4-D</a>	0.07	0.07	Kidney, liver, or adrenal gland problems	Runoff from herbicide used on row crops
<a href="#">Dalapon</a>	0.2	0.2	Minor kidney changes	Runoff from herbicide used on rights of way
<a href="#">1,2-Dibromo-3-chloropropane (DBCP)</a>	zero	0.0002	Reproductive difficulties; increased risk of cancer	Runoff/leaching from soil fumigant used on soybeans, cotton, pineapples, and orchards
<a href="#">o-Dichlorobenzene</a>	0.6	0.6	Liver, kidney, or circulatory system problems	Discharge from industrial chemical factories
<a href="#">p-Dichlorobenzene</a>	0.075	0.075	Anemia; liver, kidney or spleen damage; changes in blood	Discharge from industrial chemical factories
<a href="#">1,2-Dichloroethane</a>	zero	0.005	Increased risk of cancer	Discharge from industrial chemical factories
<a href="#">1,1-Dichloroethylene</a>	0.007	0.007	Liver problems	Discharge from industrial chemical factories
<a href="#">cis-1,2-Dichloroethylene</a>	0.07	0.07	Liver problems	Discharge from industrial chemical factories
<a href="#">trans-1,2-Dichloroethylene</a>	0.1	0.1	Liver problems	Discharge from industrial chemical factories

<a href="#">Dichloromethane</a>	zero	0.005	Liver problems; increased risk of cancer	Discharge from drug and chemical factories
<a href="#">1,2-Dichloropropane</a>	zero	0.005	Increased risk of cancer	Discharge from industrial chemical factories
Di(2-ethylhexyl) adipate	0.4	0.4	Weight loss, liver problems, or possible reproductive difficulties.	Discharge from chemical factories
Di(2-ethylhexyl) phthalate	zero	0.006	Reproductive difficulties; liver problems; increased risk of cancer	Discharge from rubber and chemical factories
<a href="#">Dinoseb</a>	0.007	0.007	Reproductive difficulties	Runoff from herbicide used on soybeans and vegetables
<a href="#">Dioxin (2,3,7,8-TCDD)</a>	zero	0.00000003	Reproductive difficulties; increased risk of cancer	Emissions from waste incineration and other combustion; discharge from chemical factories
<a href="#">Diquat</a>	0.02	0.02	Cataracts	Runoff from herbicide use
<a href="#">Endothall</a>	0.1	0.1	Stomach and intestinal problems	Runoff from herbicide use
<a href="#">Endrin</a>	0.002	0.002	Liver problems	Residue of banned insecticide
<a href="#">Epichlorohydrin</a>	zero	TT <sup>9</sup>	Increased cancer risk, and over a long period of time, stomach problems	Discharge from industrial chemical factories; an impurity of some water treatment chemicals
<a href="#">Ethylbenzene</a>	0.7	0.7	Liver or kidneys problems	Discharge from petroleum refineries



<a href="#">Ethylene dibromide</a>	zero	0.00005	Problems with liver, stomach, reproductive system, or kidneys; increased risk of cancer	Discharge from petroleum refineries
<a href="#">Glyphosate</a>	0.7	0.7	Kidney problems; reproductive difficulties	Runoff from herbicide use
<a href="#">Heptachlor</a>	zero	0.0004	Liver damage; increased risk of cancer	Residue of banned termiticide
<a href="#">Heptachlor epoxide</a>	zero	0.0002	Liver damage; increased risk of cancer	Breakdown of heptachlor
<a href="#">Hexachlorobenzene</a>	zero	0.001	Liver or kidney problems; reproductive difficulties; increased risk of cancer	Discharge from metal refineries and agricultural chemical factories
<a href="#">Hexachlorocyclopentadiene</a>	0.05	0.05	Kidney or stomach problems	Discharge from chemical factories
<a href="#">Lindane</a>	0.0002	0.0002	Liver or kidney problems	Runoff/leaching from insecticide used on cattle, lumber, gardens
<a href="#">Methoxychlor</a>	0.04	0.04	Reproductive difficulties	Runoff/leaching from insecticide used on fruits, vegetables, alfalfa, livestock
<a href="#">Oxamyl (Vydate)</a>	0.2	0.2	Slight nervous system effects	Runoff/leaching from insecticide used on apples, potatoes, and tomatoes
<a href="#">Polychlorinated biphenyls (PCBs)</a>	zero	0.0005	Skin changes; thymus gland problems; immune deficiencies; reproductive or nervous system difficulties; increased risk of cancer	Runoff from landfills; discharge of waste chemicals

<a href="#">Pentachlorophenol</a>	zero	0.001	Liver or kidney problems; increased cancer risk	Discharge from wood preserving factories
<a href="#">Picloram</a>	0.5	0.5	Liver problems	Herbicide runoff
<a href="#">Simazine</a>	0.004	0.004	Problems with blood	Herbicide runoff
<a href="#">Styrene</a>	0.1	0.1	Liver, kidney, or circulatory system problems	Discharge from rubber and plastic factories; leaching from landfills
<a href="#">Tetrachloroethylene</a>	zero	0.005	Liver problems; increased risk of cancer	Discharge from factories and dry cleaners
<a href="#">Toluene</a>	1	1	Nervous system, kidney, or liver problems	Discharge from petroleum factories
<a href="#">Toxaphene</a>	zero	0.003	Kidney, liver, or thyroid problems; increased risk of cancer	Runoff/leaching from insecticide used on cotton and cattle
<a href="#">2,4,5-TP (Silvex)</a>	0.05	0.05	Liver problems	Residue of banned herbicide
<a href="#">1,2,4-Trichlorobenzene</a>	0.07	0.07	Changes in adrenal glands	Discharge from textile finishing factories
<a href="#">1,1,1-Trichloroethane</a>	0.20	0.2	Liver, nervous system, or circulatory problems	Discharge from metal degreasing sites and other factories
<a href="#">1,1,2-Trichloroethane</a>	0.003	0.005	Liver, kidney, or immune system problems	Discharge from industrial chemical factories

<a href="#">Trichloroethylene</a>	zero	0.005	Liver problems; increased risk of cancer	Discharge from metal degreasing sites and other factories
<a href="#">Vinyl chloride</a>	zero	0.002	Increased risk of cancer	Leaching from PVC pipes; discharge from plastic factories
<a href="#">Xylenes (total)</a>	10	10	Nervous system damage	Discharge from petroleum factories; discharge from chemical factories

Maximum Contaminant Level (MCL) – The highest level of a contaminant that is allowed in drinking water. MCLs are set as close to MCLGs as feasible using the best available treatment technology and taking cost into consideration. MCLs are enforceable standards.

Maximum Contaminant Level Goal (MCLG) – The level of a contaminant in drinking water below which there is no known or expected risk to health. MCLGs allow for a margin of safety and are non-enforceable public health goals.

Treatment Technique (TT) – A required process intended to reduce the level of a contaminant in drinking water.

Units are in milligrams per liter (mg/L) unless otherwise noted. Milligrams per liter are equivalent to parts per million.